

Moving Details.

# Price list Glass Door Fittings and Systems

Edition 2024

2024 | Price list Glass Door Fittings and Systems

**dg** DORMA  
GLAS®

# Overview price lists and discount groups

Price list title	Functional areas	Discount groups State 01/24
Glass door fittings and systems		
Glass door fittings and systems spare parts	Sliding Door Fittings Glass door fittings single-action Glass door fittings double action Patch fittings and profile systems Levers, handle bars and pull grips	I
MUTO spare parts		
HSW / FSW / BSW		
HSW / FSW / BSW spare parts	Glass Sliding and Folding Walls	II
UNIQUIN		
UNIQUIN spare parts	Glass Partition Walls	III
Basic programme glass solutions	Sliding Door Systems Pivoting Door Systems single action Pivoting Door Systems double action Patch fittings and profile systems	I
justo Line	justo TURN justo SLIDE justo GRIP justo FLIPP	IV (net prices)
dormakaba Door Closer, security accessories and Drives for glass systems	Door Closer c-lever and digital cylinders MAGNEO PORTEO	V VI VII VIII

**Please note:**

Individual articles within a price list may be assigned to a **different discount group**. These are marked accordingly.

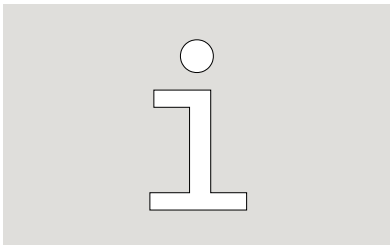

**02** **General information**

Price list overview	2
Explanation of Art. No. / Finishes	4 – 5
Delivery / Transit times	6
Application possibilities	8 – 11
Index of content	12 – 15



**17** **Sliding door fittings**



**104** **Glass door fittings single-action**



**172** **Glass door fittings double action**



**184** **Patch fittings and profile systems**



**275** **Levers, handle bars and pull grips**



**284** **Finishes / Colors**

Color samples	284
Color overview	288 – 292

# Explanation of article numbers

On the basis of OFFICE Junior, profile cylinder, left hand, finish Alu silver EV1

Complete article no: 8.11.200.101.99

8	-	11	-	200	-	101	-	99
Plant DORMA-Glas		Fitting group		Article definition		Finish		Salable article

Short version in this price list

**11.200**

The indication for "Plant DORMA-Glas" and "Salable article" are always fix components of the complete article no.

## Pictographs / Pictures

The pictographs in this price list have been included for guidance only.  
They are not true to scale and do not constitute a binding description of the exact application of the products!

**Subject to change without notice.**

## Technical Support / Application technology

In case of any questions or need for assistance with creating complete solutions our department for technical support will be pleased to help you.

Your benefits:

- Technical advice for glass door fittings products
- Support for creating complete solutions
- Assistance in terms of installation issues

# Finishes

## Finish codes

The finish codes at the top of the price columns inform you about the materials, colors and finishes available for the products. They can differ with regards to the various products, therefore only those finishes indicated with a price for the respective product are available.

Please contact us if your required finish is not shown there. We will endeavour to help you.

Base parts, various material, untreated surfaces	
000	Base parts
Aluminium, powder coated	
Black	
304	AL powder coated, Jet black, smooth, matte (sim. RAL 9005)
385	AL powder coated, Jet black, fine texture, matte (sim. RAL 9005)
White	
300	AL powder coated, Traffic white, smooth, glossy (sim. RAL 9016)
350	AL powder coated, Traffic white, smooth, semi gloss (sim. RAL 9016)
384	AL powder coated, Traffic white, smooth, flat matte (sim. RAL 9016)
Grey	
382	AL powder coated, Graphite, fine texture, matte (scratch resistant)
383	AL powder coated, similar DB 703, smooth, matte, perl glimmer effect
Metall look	
318	AL powder coated, similar anodized EV1, smooth, matte
331	AL powder coated, similar anodized Silver, smooth, matte
309	AL powder coated, similar anodized C35, smooth matte
330	AL powder coated, similar stainless steel, smooth, semi gloss
Specials	
398	AL powder coated, Special color, high weather resistant
399	AL powder coated, Special color  (Standard powder according to the corresponding overview on our website. A price surcharge is possible for special colors outside the color range specified there.)

## Note

Special anodized shades (199) and special colors (399 and 398) on request; please enquire with color samples if available.

Finish differences through production cannot be totally excluded.

Aluminium, mill finish and anodized	
100	AL mill finish
Silver look	
101	AL anodized, EV1, sanded, matte (for profiles: stained, matte)
114	AL anodized, EV1 Deco, satin, matte (compatible with finish 150)
150	AL anodized, Silver, satin, matte (compatible with finish 114)
Stainless Steel look	
107	AL anodized, similar stainless steel, polished, matte
113	AL anodized, similar stainless steel, satin (for profile material) (similar Anodizing II C 31)
157	AL anodized, similar stainless steel, satin
Brass look	
105	AL anodized, brass-coloured EV3
106	AL anodized, similar brass, smooth, glossy
Black	
108	AL anodized, dark bronze (DB14)
109	AL anodized, Black, satin, matte
Specials	
199	AL anodized, special
Stainless steel, various finish treatments	
700	Stainless steel, satin (compatible with 750)
750	Stainless steel, satin (for MUNDUS) (compatible with 700)
701	Stainless steel, polished (compatible with 751)
751	Stainless steel, polished (for MUNDUS) (compatible with 701)
Brass, various finish treatments	
503	Brass, polished
Plastic, various finish treatments	
Colored	
803	Plastic, Black, dyed through
805	Plastic, Traffic white, dyed through
Chromed	
804	Plastic, satin chromed

Diverse codes of our Powder Coating Standard Colors are to find under this link:  
<https://www.dorma-glas.com/en/service/infopoint/material-and-surfaces/>

## Delivery periods

The delivery periods pertaining to our products depend on the system-related preparation times and the transit times relevant to the destination concerned. Within 24 hours (one working day) following order receipt you will receive from us a corresponding confirmation of order receipt or, in the case of standard product orders, a normal order confirmation.

The standard times given in this price list are for guidance only. The precise order-specific delivery periods are shown in the order confirmation, which will be sent to you once all the details of the order have been clarified. The cited dates will take into account not only the time necessary for transportation/shipment but also any specific requirements previously agreed such as consignment groupage, collective delivery and designated departure dates.

## Preparation times

This is defined as the number of working days from the date of order confirmation until the products are ready for dispatch at the factory in Bad Salzuflen.

The likely preparation times are indicated by the color coding of the price backgrounds.

**2 5 10 15 20 25**

The color strip (at the bottom of price list pages) numeralizes the preparation time in working days.

They relate to order quantities per item of max.

25 pieces for individual fittings/sets

120 m for profiles

The preparation times for larger quantities respectively for projects, customised solutions and modifications may differ. We will be glad to inform you on request of the delivery times that then apply. Subsequent order changes will result in the preparation and delivery times being recalculated and reconfirmed.

## Overview Freight flat rates

**Flat rate freight charge of € 9.90 per order.**

**Length surcharge for bundles from 2.30 m: one-off € 19.90 per order.**

**Express surcharge of € 44.90 per order.**

**Note: Flat rates and surcharges can be added together.**

**A low-quantity surcharge of 10.00 € is raised for each order whose net invoice value is less than 60.00 €.**

**All prices are gross prices exclusive freight and packing!  
Please consider our general terms and conditions shown on  
[www.dorma-glas.com](http://www.dorma-glas.com)**

## Transit times

This is defined as the number of working days it takes to transport the items door-to-door from Bad Salzuflen to the delivery address. Some transit times to various countries of destination are indicated in the table below. Please note that the number of days indicated is subject to variations arising from designated departure days. We will gladly quote transit times for countries not listed.

Country (Delivery destination)	Departure days (from Bad Salzuflen)	Transit time to delivery address (Working days)
BE, LU, NL	daily	2 - 3
BA, BG, HR	Fri	5 - 8
CZ	Tue + Fri	3 - 4
DK	Tue + Fri	2 - 3
EE, LV, LT, NO	Tue + Fri	4 - 8
FI, SE	Tue + Fri	6 - 7
FR, GB	daily	4 - 6
GR	Thu	5
HU	Tue, Fri	4
IE	Tue + Fri	5 - 7
ES, IT	Tue + Fri	4 - 8
PL	daily	4
PT	Fri	5 - 8
RO, RS	Fri	6 - 7
SK, SI	Tue + Fri	4 - 6
TR	Fri	7 - 8

Express (KEP services) for all countries

There is the option of delivering packages with a maximum length of 2.70 m and a maximum weight of 25 kg within the next working day.

For countries with two departure days a week, forwarders reserve the right to reduce the weekly departures to one if the volume of their customers is too low.

## Overview service fees

Service	Fees	Note
Change of order	10,00 €	On Customer request after receipt of order confirmation
Cancellation of order	15,00 €	On Customer request after receipt of order confirmation
Delivery time reduction	20,00 €	On Customer request after receipt of order confirmation
Change of drawing	20,00 €	From 2nd change of approval drawing for HSW / UNIQUIN

**We reserve the right to charge these service fees.**



# Sliding door fittings

	MUTO Comfort M 60	MUTO Comfort L 80	MUTO Comfort L 80 Pocket	MUTO Premium XL 80/150	MUTO Premium Self-Closing 120	RS 120	MANET
<b>Standard applications</b>							
Glass door for wall installation	●	●		●	●	●	●
Glass door for wall installation, bridging over door jamb	●	●		●	●		●
Glass door for wall installation, Synchro		●		●		●	
Glass door for ceiling installation	●	●		●	●	●	
Glass door for ceiling slot installation			●				
Glass door for wall pocket installation			●				
Glass door for ceiling installation, Synchro		●		●		●	
Glass door with glass sidelights	●	●		●	●	●	
Glass door for ceiling slot installation with glass sidelights			●				
Glass door for wall pocket installation with glass sidelights			●				
Glass door with glass sidelights, Synchro		●		●		●	
Glass door with glass overhead lights and sidelights		●		●	●		●
Timber door for wall installation	●	●		●	●	●	
Timber door for ceiling installation	●	●		●	●	●	
Timber door for ceiling slot installation			●				
Timber door for wall pocket installation			●				
Timber door with glass sidelight/s	●	●		●	●	●	
Timber door for ceiling slot installation with glass sidelights			●				
Timber door for wall pocket installation with glass sidelights			●				
Timber door with glass overhead light and sidelight/s		●		●	●		

## Caption

- suitable / available
- of limited suitability / only available for selected variants



# Sliding door fittings

	MUTO Comfort M 60	MUTO Comfort L 80	MUTO Comfort L 80 Pocket	MUTO Premium XL 80/150	MUTO Premium Self-Closing 120	RS 120	MANET
<b>Special applications individual configuration, customisation on-site (advisory service necessary)</b>							
Glass door for ceiling slot installation, double panel assemblies			●				
Glass door for wall pocket installation, double panel assemblies			●				
Glass door for wall installation, double panel assemblies, standard	●	●		●	●	●	●
Glass door for wall installation, double panel assemblies, bridging over door jamb	●	●		●	●		●
Glass door for wall installation, curved system							
Glass door for ceiling installation, curved system							
Glass door with glass sidelights, double-leaf		●		●	●	●	
Glass door with glass overhead lights and sidelights, Synchro		●		○			
Glass door with glass overpanels & glass sidelights, double-leaf		●		●	●	●	●
Glass door with glass overpanels & glass sidelights, curved system							
Free-standing glass assemblies							
Timber door for wall installation, Synchro		●		●		●	

## Caption

- suitable / available
- of limited suitability / only available for selected variants

For further information such as max. door measurements please consider our technical brochures.

# Glass door fittings

	STUDIO Rondo	STUDIO Classic	STUDIO Gala 2.0	STUDIO Arcos	STUDIO1121	STUDIO Medio	OFFICE Junior	OFFICE Classic	OFFICE Mundus	OFFICE Arcos	TENSOR / MARCATO	RP
<b>Applications</b>												
For assemblies in open-air areas												○
For assemblies in interior (single- and double-leaf)	●	●		●	●	●	●	●	●	●	●	●
For standard toughened glass assembly types (with side lights and / or over panels)											●	○
Usable for objects							●	●	●	●	●	●
For double action doors											●	●
For single action doors	●	●	●	●	●	●	●	●	●	●		●
<b>Material / Finishes</b>												
Aluminum (according to RAL / Anodised coating)	●	●	●	●	●	●	●	●	●	●	●	●
Brass	●											
Stainless steel							●		●			
Special anodised coating / Special color	●	●		●	●	●	●	●	●	●		●

## Caption

- suitable / available
- of limited suitability / only available for selected variants

For further information such as max. door measurements please consider our technical brochures.

# Patch fittings and profile systems

	MUNDUS Comfort	MUNDUS Premium	UNIVERSAL	BEYOND	Patchfitting EA	Door rails TP/TA EASY Safe	Door rails TP/TA 76,5	MANET	Wall connecting profile	MR22 / MR28	Locks SG
<b>Applications</b>											
For assemblies in open-air areas	●	●	●		●	●	●	●	○		○
For assemblies in interior	●	●	●	●	●	●	●	●	●	●	●
For standard toughened glass assembly types	●	●	●	●	●	●	●	●	●		●
For individual planed systems (angled systems, reinforcement)	○	○	●	●	●	●	●	○	●		●
For double action doors	●	●	●	●		●	●	●	●		○
For single action doors	●	●	●	●	●	●	●	●	●		○
<b>Material / Finishes</b>											
Aluminum (according to RAL / Anodised coating)	●	●	●	●	●	●	●		●	●	●
Brass			●		●				●		
Stainless steel	●	●	●		●	●	●	●	●		○
Special anodised coating / Special color		●	●		●	●	●		●		●

## Caption

- suitable / available
- of limited suitability / only available for selected variants

For further information such as max. door measurements please consider our technical brochures.

# Index of content

## Sliding door fittings

<b>17</b>	<b>MUTO Comfort M 60</b>
20	Glass door / timber door, installation at wall and ceiling
21	Glass door / timber door, with glass side panel, single and double-sided, installation at ceiling
<b>23</b>	<b>MUTO Comfort L 80</b>
26	Glass door / timber door, single-leaf, installation at walls and ceilings
27	Glass door / timber door, double-leaf, installation at walls and ceilings
28	Glass door / timber door, single- or double-leaf with glass overpanel and glass sidelights
29	Glass door / timber door, single or double-leaf, with glass sidelight, single and double sided, installation at ceiling
<b>33</b>	<b>MUTO Comfort L 80 Pocket</b>
36	Glass door / timber door, single and double leaf, with and without sidelight, installation in ceiling slot
37	Glass door / timber door, single and double leaf, with and without sidelight, door movable into wall pocket
38	Profile kits for wall pocket construction for glass doors and for timber doors
39	Single components MUTO Comfort L 80 Pocket
<b>41</b>	<b>MUTO Premium XL 80/150</b>
44	Glass door / timber door, single-leaf, installation at wall or ceiling
45	Glass door / timber door, double-leaf, installation at walls and ceilings
46	Glass door / timber door, single and double-leaf with glass sidelight/s, one and two-sided, installation at ceiling
47	Glass door / timber door, single-leaf with glass overpanel and glass sidelights
48	Glass door / timber door, double-leaf with glass overpanel and glass sidelights
<b>53</b>	<b>MUTO Premium Self-Closing 120</b>
56	Glass door / timber door, single-leaf, installation at wall or ceiling
57	Glass door / timber door, single-leaf, installation at wall or ceiling
58	Glass door / timber door, with glass sidelight/s, one-sided and two-sided
59	Glass door / timber door, with glass overpanel and glass sidelights
<b>63</b>	<b>MUTO Premium Telescopic 80</b>
66, 70	Glass door for installation at wall
67, 68, 71, 72	Glass door for installation at ceiling / Glass door for installation at ceiling with glass sidelight
69, 73	Glass door for installation at glass
74	Timber door for installation at wall
75, 76	Timber door for installation at ceiling / Glass door for installation at ceiling with glass sidelight
77	Timber door for installation at glass
<b>78</b>	<b>Accessories for the MUTO range</b>
78	MUTO integrated locking mechanism/status indicator
79	MUTO various accessories
<b>81</b>	<b>RS 120</b>
84	Glass door for installation at wall or ceiling
85	Glass door for installation to wall / ceiling or with sidelight/s, Synchro
86	Glass door with sidelight/s
87	Timber door for installation at wall or ceiling

<b>91</b>	<b>MANET, Sliding</b>
94	Glass door for installation at wall
96	Glass door with glass overpanels & glass sidelights
100	Accessories, single components
	<b>General accessories for Sliding door fittings</b>
256	SG - Centre and corner locks, strike boxes
266	U-profiles

## Glass door fittings single action doors

### STUDIO

104	STUDIO Rondo
112	STUDIO Classic
118	STUDIO Gala 2.0
124	STUDIO Arcos
130	STUDIO1121
134	STUDIO Medio

### OFFICE

138	OFFICE Junior
144	OFFICE Classic
150	OFFICE Mundus
154	OFFICE Arcos

### 158 **Special hinges**

### General accessories for "Glass door fittings single action doors"

162	Frame pivots
164	Frame pockets, push-on sleeves, strike plates, door stop EASY Stop
166	Door rails for interior doors
169	Floor bearings, profile cylinder, door bolt, door snapper, floor sockets

## Glass door fittings double action doors

172	<b>TENSOR</b>
176	<b>MARCATO Motion</b>
180	<b>RP-Frame profile with transom door closer</b>

### General accessories for "Glass door fittings double action doors"

175	Door stops
260	Centre and corner locks, strike boxes

## Patch fittings and profile systems

184	<b>Patch fitting MUNDUS Comfort</b>
190	<b>Patch fitting MUNDUS Premium</b>
198	<b>Patch fitting UNIVERSAL</b>
207	<b>Patch fitting UNIVERSAL Motion NG33</b>
208	<b>Patch fitting UNIVERSAL light</b>
212	<b>Single action door fitting BEYOND</b>
216	<b>EA-Patch fittings for single action doors</b>
222	<b>Door rails TP/TA EASY Safe</b>
234	<b>Door rails TP/TA 76,5</b>
242	<b>Single action door fitting MANET</b>
250	<b>Wall connecting profiles</b>
256	<b>Frame systems MR 22 / MR 28</b>
260	<b>Centre and corner locks SG, strike boxes</b>
	<b>General accessories for "Patch fittings and profile systems"</b>
270	Clamping fitting, U-profile
271	Pivot bearing, floor bearing, strike plates, floor sockets

## Levers, handle bars and recessed pull grips

276	<b>Levers with follower</b>
278	<b>Levers with roses</b>
280	<b>Handle bars</b>
282	<b>Pull grips and door knobs</b>

## Samples

284	<b>Color samples</b>
286	<b>Register of colors</b>

## Product register of example pictures

288	<b>Product register of example pictures</b>
-----	---------------------------------------------





# MUTO Comfort M 60



Technical data	
Glass	TSG, LSG (2 x TSG)
Glass thickness	8 - 12 mm
Max. door weight	60 kg
Application	single-leaf, sidelight
Material	Aluminium
Finishes	Anodized- and RAL-Colors (coated)
Kind of installation	Wall and ceiling
Specials	DORMOTION (optionally retrofittable) Tested acc. DIN EN 1527:2020-04 Height readjustable without dismantling +4/-2 mm

Example view for MUTO Comfort M 60 installation at wall

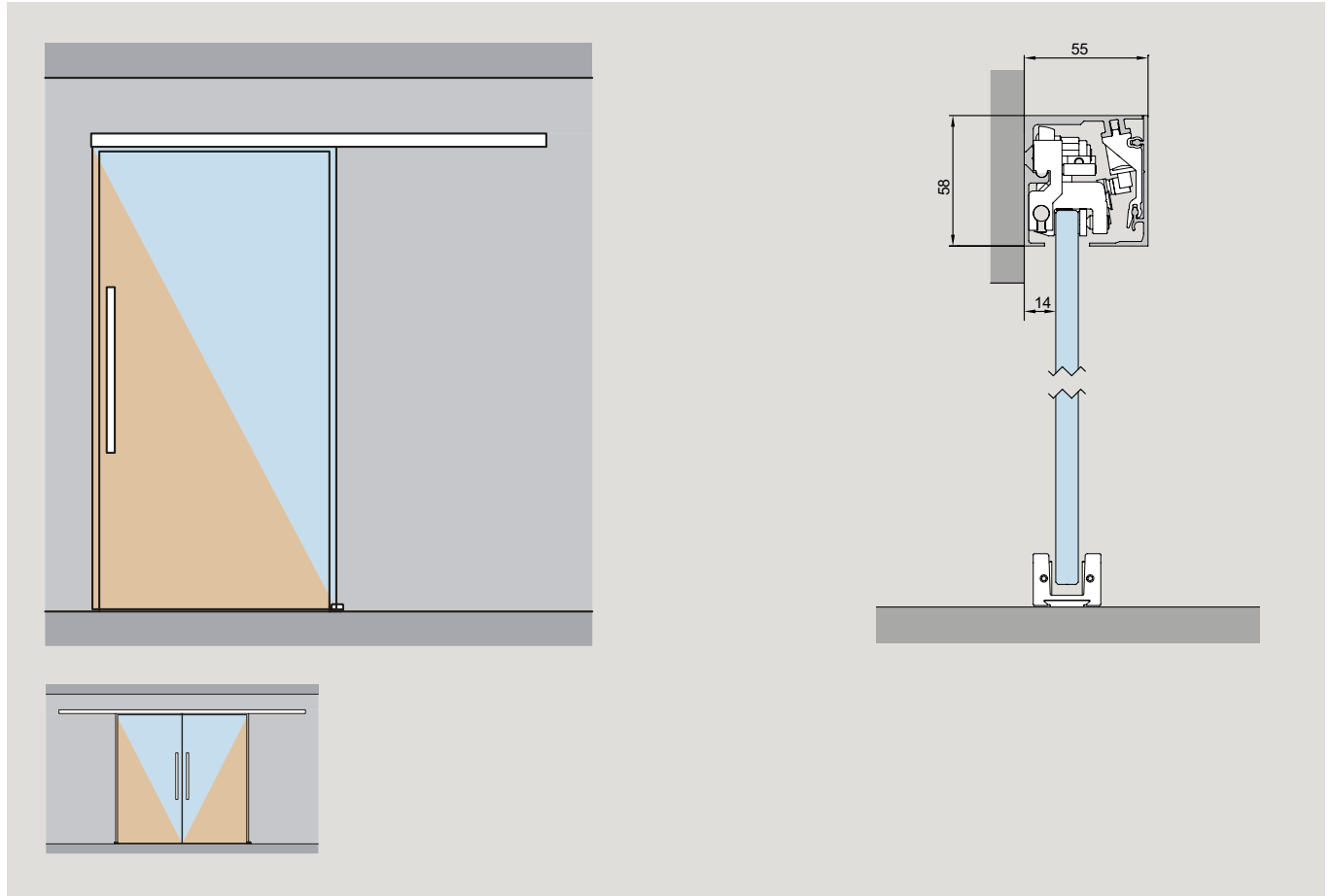

Example view for MUTO Comfort M 60 installation at ceiling

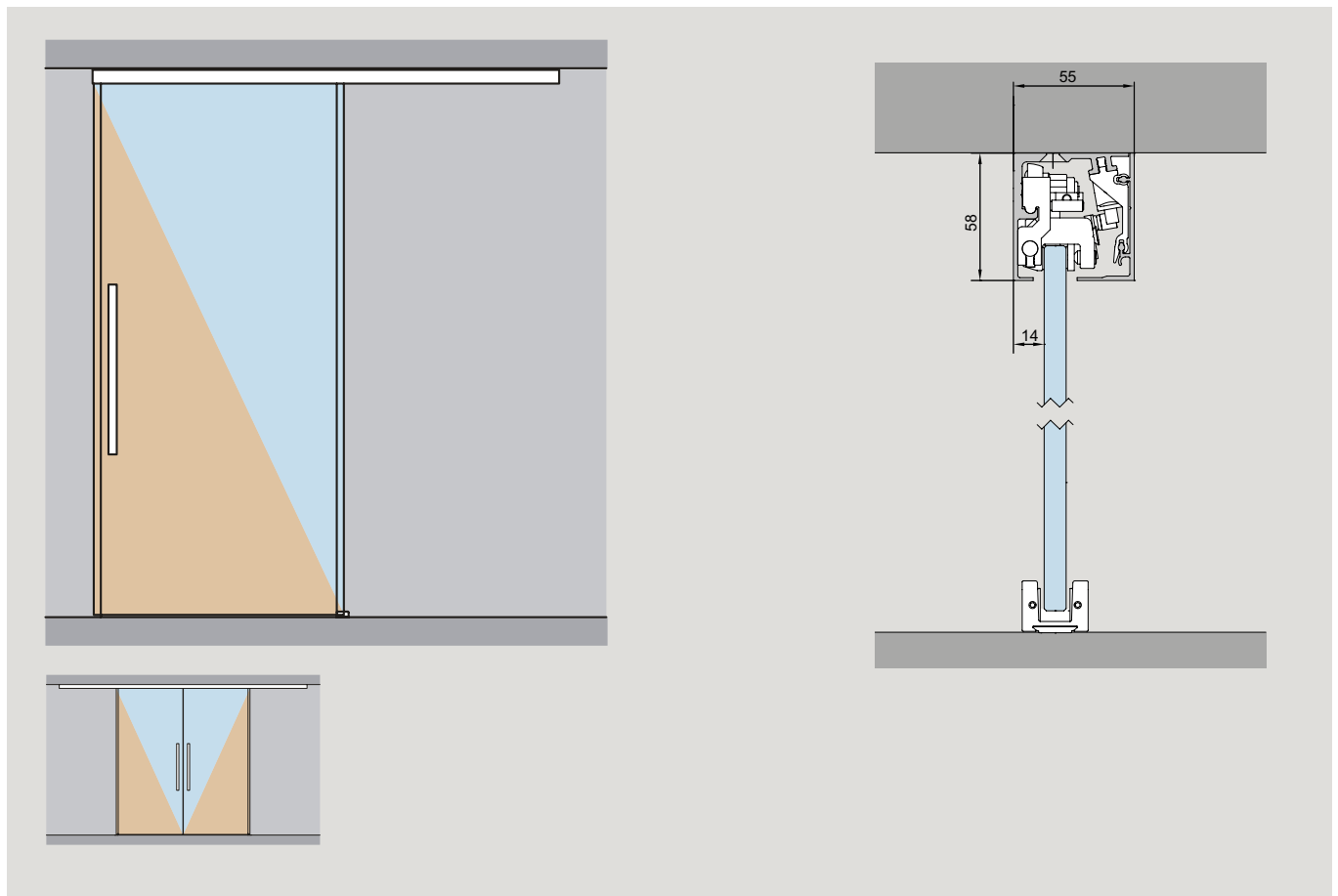

**Example view for MUTO Comfort M 60 with glass sidelight/s, installation at ceiling**

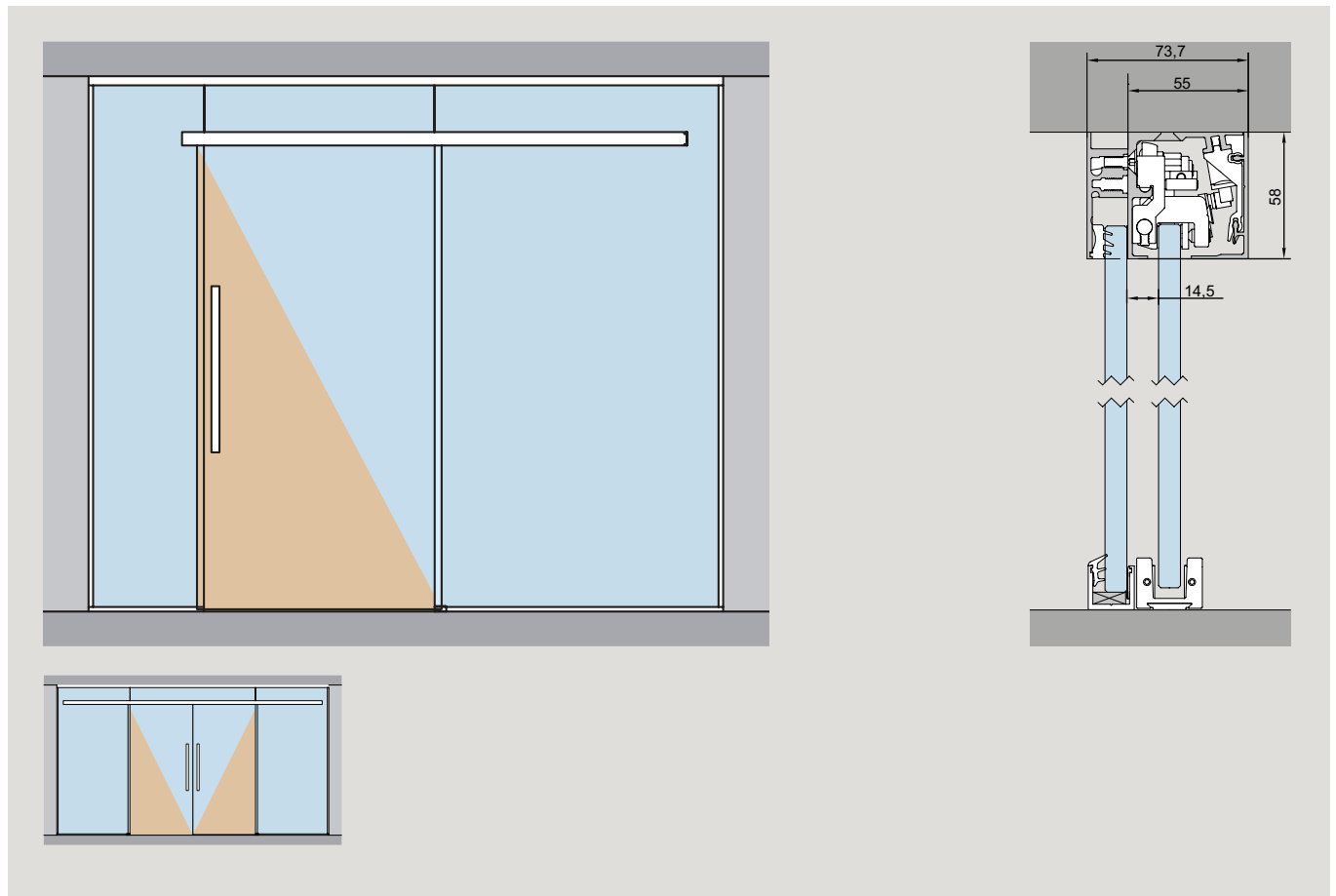

**Complete sets (optional with DORMOTION)  
for glass door (8-12 mm) or timber door (28-50 mm), installation at wall and ceiling**

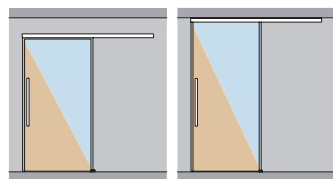

Art. No. Description

AL anod Silver (150)	AL anod sim. Stainl- Steel satin (157)	AL p-coat Jet black (304)	AL p-coat Traffic white (350)	AL anod Special (199)	AL p-coat Special color (399) *
€/Piece	€/Piece	€/Piece	€/Piece	€/Piece	€/Piece

Sliding door fittings

**Complete sets (optional with DORMOTION)  
For Timber door application the adapter profile  
36.941 will be necessitated**

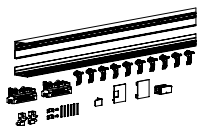

**MUTO Comfort M 60**  
consisting of:  
1 track profile 1900 mm  
1 cover profile 1900 mm  
2 clamp carriers  
(for 8 – 12 mm glass thickness)  
with anti-jump mechanism  
2 endstops with safety catch and anti jump device  
1 floor guide  
2 end caps

**Defined lengths  
for max.. 2400 mm panel width**

**Installation at wall**

<b>36.670</b>	for 950 mm panel width / 1900 mm profile length	<b>251,00</b>	<b>279,00</b>	<b>304,00</b>	<b>251,00</b>	<b>337,00</b>	<b>337,00</b>
<b>36.676</b>	do. with MUTO Comfort M 60 DORMOTION unit	<b>334,00</b>	<b>362,00</b>	<b>387,00</b>	<b>334,00</b>	<b>420,00</b>	<b>420,00</b>
<b>36.671</b>	for 1200 mm panel width / 2400 mm profile length	<b>322,00</b>	<b>350,00</b>	<b>381,00</b>	<b>322,00</b>	<b>406,00</b>	<b>406,00</b>
<b>36.677</b>	do. with MUTO Comfort M 60 DORMOTION unit	<b>406,00</b>	<b>434,00</b>	<b>462,00</b>	<b>406,00</b>	<b>488,00</b>	<b>488,00</b>

**Installation at ceiling**

<b>36.672</b>	for 950 mm panel width / 1900 mm profile length	<b>251,00</b>	<b>279,00</b>	<b>304,00</b>	<b>251,00</b>	<b>337,00</b>	<b>337,00</b>
<b>36.678</b>	do., incl. MUTO Comfort M 60 DORMOTION unit	<b>334,00</b>	<b>362,00</b>	<b>387,00</b>	<b>334,00</b>	<b>420,00</b>	<b>420,00</b>
<b>36.673</b>	for 1200 mm panel width / 2400 mm profile length	<b>322,00</b>	<b>350,00</b>	<b>381,00</b>	<b>322,00</b>	<b>406,00</b>	<b>406,00</b>
<b>36.679</b>	do., incl. MUTO Comfort M 60 DORMOTION unit	<b>406,00</b>	<b>434,00</b>	<b>462,00</b>	<b>406,00</b>	<b>488,00</b>	<b>488,00</b>

**Individual lengths  
max. 54940 mm profile length**

**Note:**  
**For individual lengths from 1901 mm, the price is composed of the  
basic price for 1900 mm profile length plus surcharge per  
additional mm (max 5940 mm)!**

<b>36.674</b>	<b>Installation at wall</b> for max. 1300 mm panel width / 5940 mm profile length	Basic price for lengths up to 1900 mm					
		<b>251,00</b>	<b>279,00</b>	<b>304,00</b>	<b>251,00</b>	<b>337,00</b>	<b>337,00</b>
		Surcharge per mm (from 1901 mm to max. 5940)					
		<b>0,20</b>	<b>0,20</b>	<b>0,20</b>	<b>0,20</b>	<b>0,24</b>	<b>0,24</b>
<b>36.680</b>	do., incl. MUTO Comfort M 60 DORMOTION unit	Basic price for lengths up to 1900 mm					
		<b>334,00</b>	<b>362,00</b>	<b>387,00</b>	<b>334,00</b>	<b>420,00</b>	<b>420,00</b>
		Surcharge per mm (from 1901 mm to max. 5940)					
		<b>0,20</b>	<b>0,20</b>	<b>0,20</b>	<b>0,20</b>	<b>0,24</b>	<b>0,24</b>
<b>36.675</b>	<b>Installation at ceiling</b> for max. 1300 mm panel width / 5940 mm profile length	Basic price for lengths up to 1900 mm					
		<b>251,00</b>	<b>279,00</b>	<b>304,00</b>	<b>251,00</b>	<b>337,00</b>	<b>337,00</b>
		Surcharge per mm (from 1901 mm to max. 5940)					
		<b>0,20</b>	<b>0,20</b>	<b>0,20</b>	<b>0,20</b>	<b>0,24</b>	<b>0,24</b>
<b>36.681</b>	do., incl. MUTO Comfort M 60 DORMOTION unit	Basic price for lengths up to 1900 mm					
		<b>334,00</b>	<b>362,00</b>	<b>387,00</b>	<b>334,00</b>	<b>420,00</b>	<b>420,00</b>
		Surcharge per mm (from 1901 mm to max. 5940)					
		<b>0,20</b>	<b>0,20</b>	<b>0,20</b>	<b>0,20</b>	<b>0,24</b>	<b>0,24</b>

\* For systems in special color (399) or in white (350), the end caps are supplied in plastic white or anthracite lacquered.

**Glass door (8-12 mm) or timber door (28-50 mm), with glass side panel, single and double-sided, installation at ceiling**

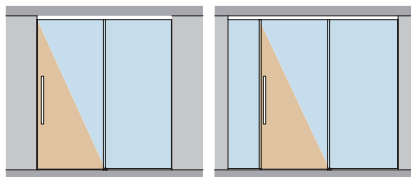

Art. No. Description

AL anod Silver (150)	AL anod sim. Stainl- Steel satin (157)	AL p-coat Jet black (304)	AL p-coat Traffic white (350)	AL anod Special (199)	AL p-coat Special color (399) *
€/Piece	€/Piece	€/Piece	€/Piece	€/Piece	€/Piece

**Complete sets (optional with DORMOTION)**  
For Timber door application the adapter profile 36.941 will be necessitated

**Individual lengths**  
max. 5940 mm profile length

**Note:**  
For individual lengths from 2181 mm, the price is composed of the basic price for 2180 mm profile length plus surcharge per additional mm (max 5940 mm)!

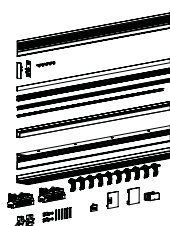

**36.682 MUTO Comfort M 60 for max. 1300 mm panel width**  
Consisting of:  
1 track rail max. 5940 mm f. side panel connection  
1 cover profile max. 5940 mm  
1 side panel profile max. 5940 mm  
1 filling profile depending on panel  
2 clamp carriers (for 8-12 mm glass thickness) with anti-jump mechanism  
2 end stops incl. safety catch and anti jump device  
1 floor guide  
2 end caps

Basic price for lengths up to 2180 mm					
434,00	478,00	519,00	434,00	558,00	558,00
Surcharge per mm (from 2181 mm to max. 5940)					
0,25	0,25	0,25	0,25	0,30	0,30

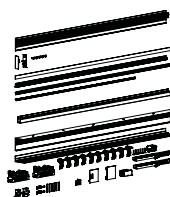





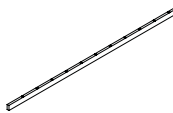
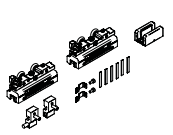
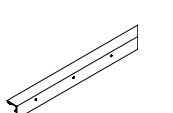
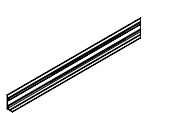
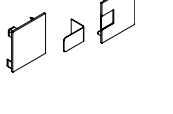

**36.683 Do. with MUTO Comfort M 60 DORMOTION unit**

Basic price for lengths up to 2180 mm					
516,00	562,00	599,00	516,00	641,00	641,00
Surcharge per mm (from 2181 mm to max. 5940)					
0,25	0,25	0,20	0,25	0,30	0,30

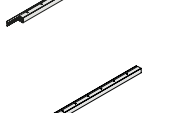
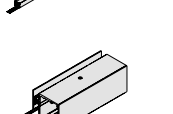
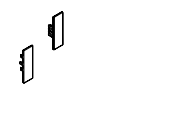
\* For systems in special color (399) or in white (350), the end caps are supplied in plastic white or anthracite lacquered.

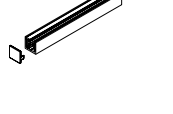
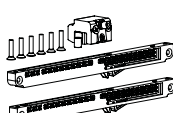
## Single components for MUTO Comfort M 60

Art. No.	Description	Base parts (000)	AL anod Silver (150)	AL anod sim. Stainl-Steel satin (157)	AL p-coat Jet black (304)	AL p-coat Traffic white (350)	AL anod Special (199)	AL p-coat Special color (399)
		€/Piece	€/Piece	€/Piece	€/Piece	€/Piece	€/Piece	€/Piece
	<b>36.941 Adapter profile for timber doors</b> 10 x 23 mm, incl. accessory set (floor guide for timber door panel), 1310 mm	<b>61,00</b>						
	<b>36.691 Accessories set:</b> consisting of: 2 clamp carriers with anti-jump mechanism 2 endstops with safety catch 1 floor guide		<b>168,00</b>	<b>168,00</b>	<b>175,00</b>	<b>175,00</b>		
	<b>36.684 Track profile for installation at wall</b> stock length 6000 mm		<b>222,00</b>	<b>255,00</b>		<b>222,00</b>	<b>305,00</b>	<b>305,00</b>
			€/m	€/m		€/m	€/m	€/m
	<b>36.687 fixed length</b>		<b>46,00</b>	<b>53,50</b>		<b>46,00</b>	<b>63,50</b>	<b>63,50</b>
	<b>36.685 Track profile for installation at ceiling</b> stock length 6000 mm		<b>222,00</b>	<b>255,00</b>		<b>222,00</b>	<b>305,00</b>	<b>305,00</b>
			€/m	€/m		€/m	€/m	€/m
	<b>36.688 fixed length</b>		<b>46,00</b>	<b>53,50</b>		<b>46,00</b>	<b>63,50</b>	<b>63,50</b>
	<b>36.686 Cover profile</b> stock length 6000 mm		<b>101,00</b>	<b>116,00</b>		<b>101,00</b>	<b>139,00</b>	<b>139,00</b>
			€/m	€/m		€/m	€/m	€/m
	<b>36.696 fixed length</b>		<b>21,00</b>	<b>24,00</b>		<b>21,00</b>	<b>28,50</b>	<b>28,50</b>
	<b>36.692 Set of end caps</b> installation at wall and ceiling Plastic, white bei (350) Plastic, anthracite lacquered (399)		<b>14,00</b>	<b>14,00</b>		<b>14,00</b>		<b>14,00</b>
	<b>36.271 Side panel profile 58 mm height, with all gaskets, for 8–13.5 mm glass thickness</b> stock length 6000 mm		<b>140,00</b>	<b>158,00</b>		<b>140,00</b>	<b>192,00</b>	<b>192,00</b>
			€/m	€/m		€/m	€/m	€/m
	<b>36.274 fixed length</b> (When ordering single components please note: Track profiles are not pre-drilled for fixing to side panel profiles. Drilling on site necessary.)		<b>28,50</b>	<b>33,50</b>		<b>28,50</b>	<b>40,50</b>	<b>40,50</b>
	<b>36.694 MUTO view protection profile</b> for side panel profile stock length 6000 mm		<b>52,50</b>	<b>61,00</b>		<b>52,50</b>	<b>78,00</b>	<b>78,00</b>
			€/m	€/m		€/m	€/m	€/m
	<b>36.695 fixed length</b>		<b>11,00</b>	<b>13,00</b>		<b>11,00</b>	<b>16,50</b>	<b>16,50</b>
	<b>36.802 MUTO Filling profile</b> stock length 6000 mm		<b>83,00</b>	<b>95,50</b>	<b>98,50</b>	<b>83,00</b>	<b>114,00</b>	<b>114,00</b>
			€/m	€/m	€/m	€/m	€/m	€/m
	<b>36.803 fixed length</b>		<b>17,50</b>	<b>20,00</b>	<b>21,00</b>	<b>17,50</b>	<b>24,00</b>	<b>24,00</b>
	<b>36.273 Set of end caps</b> for side panel profile, 58 mm height		<b>14,00</b>	<b>14,00</b>		<b>14,00</b>		<b>14,00</b>
	<b>36.810 Floor profile incl. 2 end caps</b> for side panel fixing, complete with all gaskets, for 8–13.5 mm glass thickness, stock length 6000 mm		<b>142,00</b>	<b>163,00</b>	<b>170,00</b>	<b>142,00</b>	<b>197,00</b>	<b>197,00</b>
			€/m	€/m	€/m	€/m	€/m	€/m
	<b>36.811 fixed length</b>		<b>29,50</b>	<b>34,00</b>	<b>35,50</b>	<b>29,50</b>	<b>41,00</b>	<b>41,00</b>
	<b>36.812 End caps (2 pcs.)</b> for floor profile - side panel fixing Plastic, white (350) Plastic, anthracite lacquered (399)		<b>9,80</b>	<b>9,80</b>		<b>9,80</b>		<b>9,80</b>
	<b>36.693 MUTO Comfort M 60 DORMOTION unit</b> for max. 60 kg, incl. starter min. panel width 450 mm max. panel width 1300 mm <b>(optionally retrofittable)</b>		<b>83,50</b>					

\* For systems in special color (399) or in white (350), the end caps are supplied in plastic white or anthracite lacquered.

# MUTO Comfort L 80



Technical data	
Glass	TSG, LSG (2 x TSG)
Glass thickness	8-13,5 mm
Max. door weight	80 kg
Application	single-leaf, double-leaf (glass or timberleaves), glass sidelights, at glass
Material	Aluminium
Finishes	Anodized- and RAL-Colors (coated)
Kind of installation	Wall, ceiling and at glass
Specials	DORMOTION, integrated locking mechanism and status indicator are optionally retrofittable For double leaf assemblies Synchro is optionally retrofittable Tested acc. DIN EN 1527:2020-04 Height readjustable without dismantling +5/-3 mm

Example view for MUTO Comfort L 80 installation at wall

Sliding door fittings

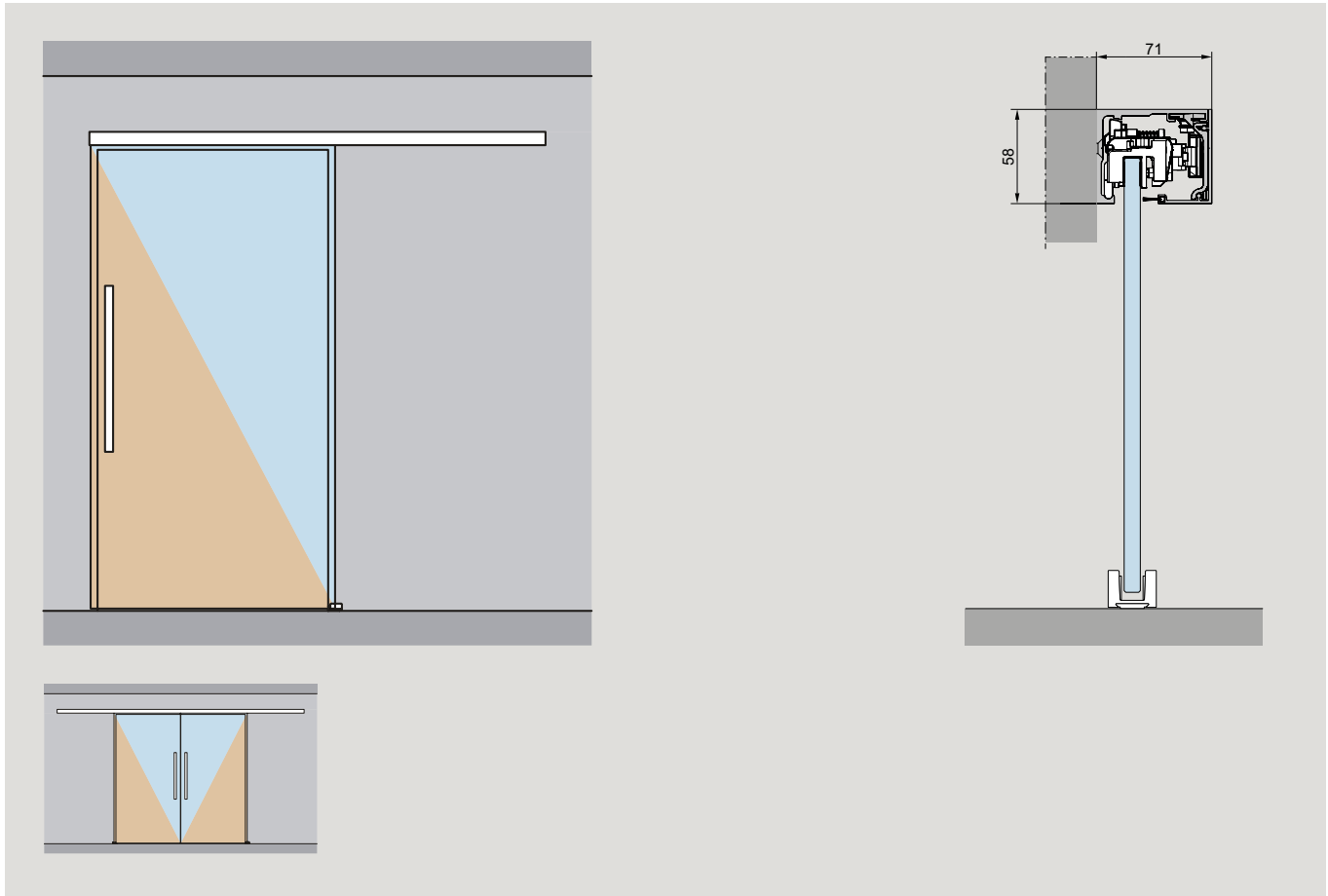

Example view for MUTO Comfort L 80 installation at ceiling

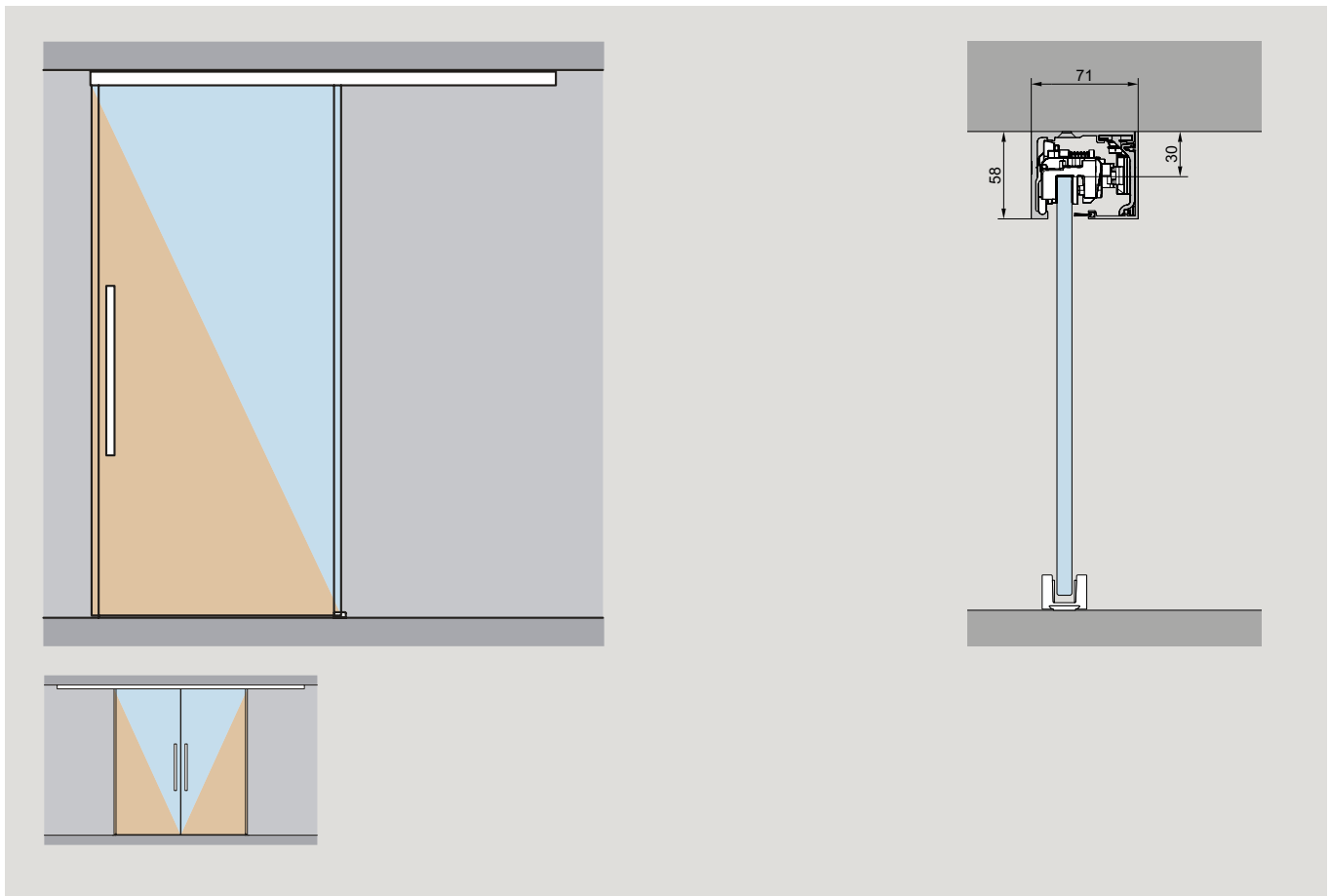



Example view for MUTO Comfort L 80 with glass sidelight/s

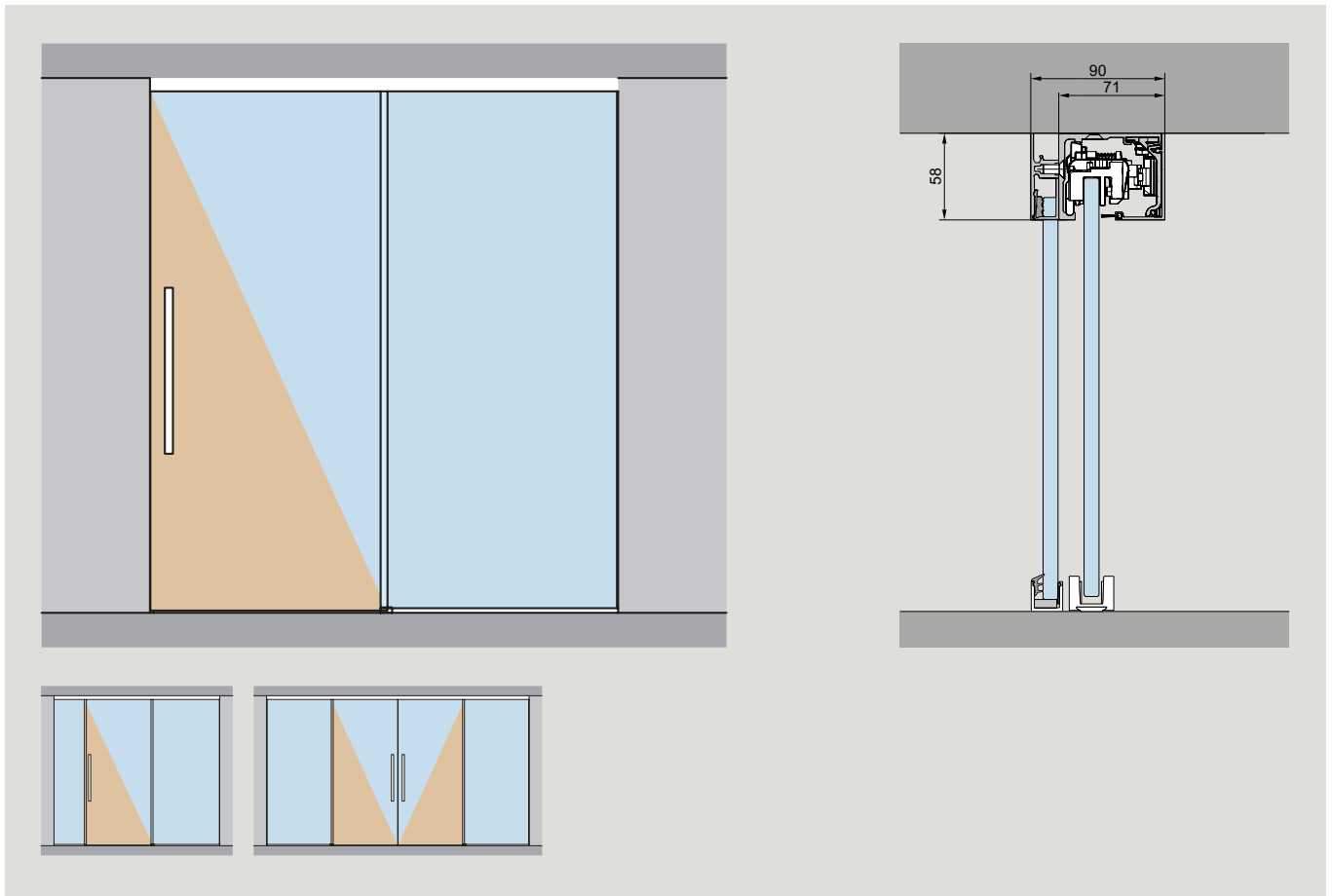

Sliding door fittings

Example view for MUTO Comfort L 80 with glass overpanel and glass sidelights

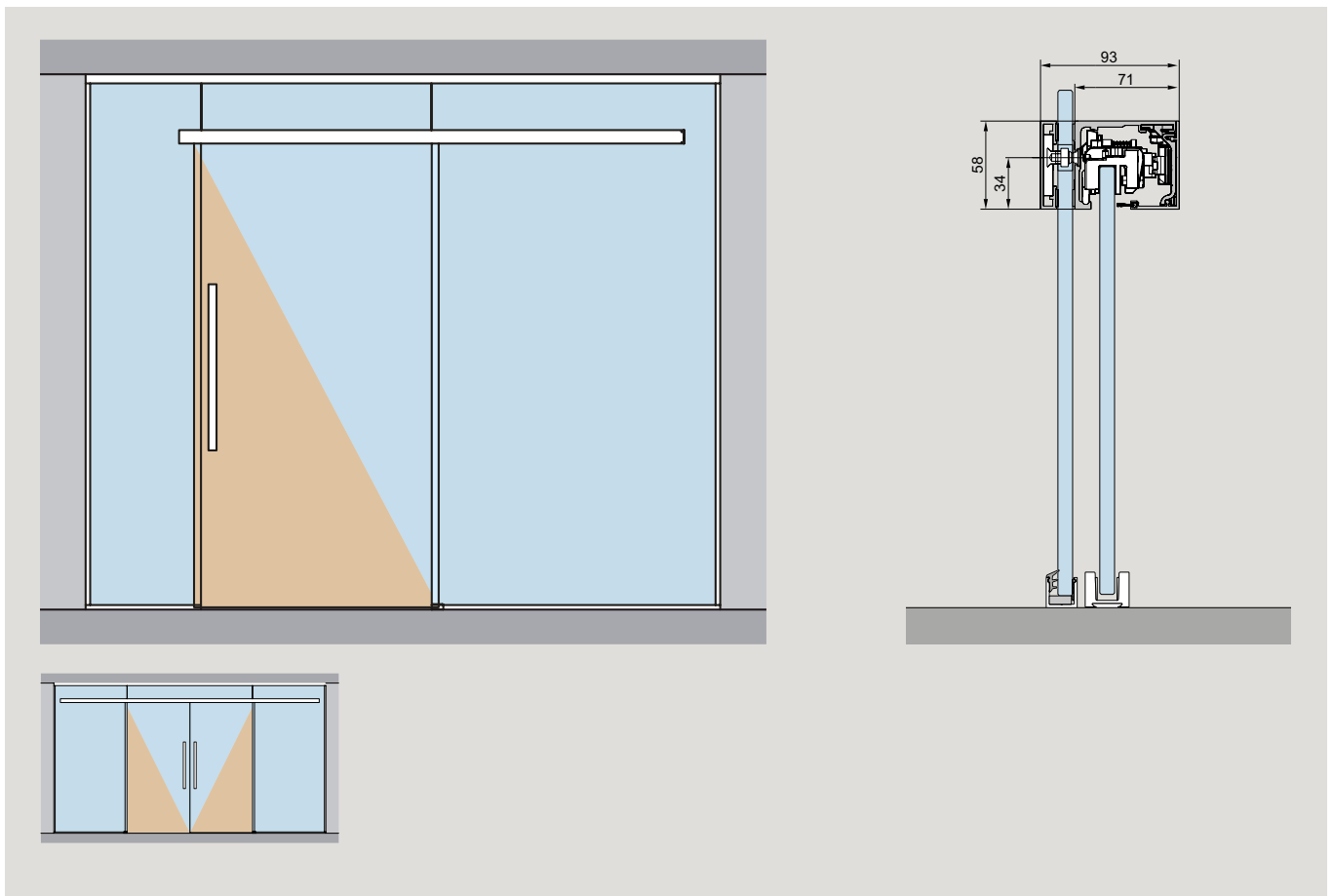

**Complete sets (optional with DORMOTION) for single-leaf glass doors (8-13.5 mm) or timber doors (28 -50 mm), installation at walls and ceilings**

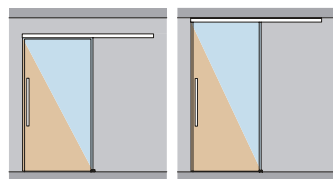

Art. No. Description

AL anod Silver (150)	AL anod sim. Steel satin (157)	AL p-coat Jet black (304)	AL p-coat Traffic white (350)	AL anod Special (199)	AL p-coat Special color (399) *
€/Piece	€/Piece	€/Piece	€/Piece	€/Piece	€/Piece

Sliding door fittings

**For Timber door application the adapter profile 36.261 / 36.262 will be necessitated**

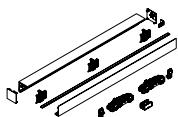

**MUTO Comfort L 80 for 1100 mm panel width**  
 consisting of:  
 1 track profile  
 1 cover profile  
 2 clamp carriers  
 (for 8-13.5 mm glass thickness) with anti-jump mechanism  
 2 endstops with safety catch and anti jump device  
 1 floor guide  
 2 end caps  
 incl. view protection brushes

**Defined lengths**

**Installation at wall**

**36.300** for 1100 mm panel width / 2180 mm profile length  
**36.301** for 1450 mm panel width / 2880 mm profile length

364,00	392,00	425,00	364,00	462,00	462,00
489,00	539,00	586,00	489,00	591,00	591,00

**Installation at ceiling**

**36.302** for 1100 mm panel width / 2180 mm profile length  
**36.303** for 1450 mm panel width / 2880 mm profile length

364,00	392,00	425,00	364,00	462,00	462,00
489,00	539,00	586,00	489,00	591,00	591,00

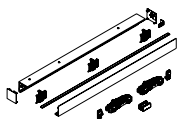

**Individual lengths**  
 max. 5910 mm

**Note:**  
**For individual lengths from 2181 mm, the price is composed of the basic price for 2180 mm profile length plus surcharge per additional mm (max 5940 mm)!**

**36.320 Installation at wall**  
 for max. 2000 mm panel width / 5940 mm profile length

Basic price for lengths up to 2180 mm					
364,00	392,00	425,00	364,00	462,00	462,00
Surcharge per mm (min. 2181 mm / max. 5940)					
0,25	0,25	0,25	0,25	0,30	0,30
Basic price for lengths up to 2180 mm					
476,00	504,00	539,00	476,00	574,00	574,00
Surcharge per mm (min. 2181 mm / max. 5940)					
0,25	0,25	0,25	0,25	0,30	0,30

**36.326** do., incl. MUTO Comfort M 60 DORMOTION unit

**36.321 Installation at ceiling**  
 for max. 2000 mm panel width / 5940 mm profile length

Basic price for lengths up to 2180 mm					
364,00	392,00	425,00	364,00	462,00	462,00
Surcharge per mm (min. 2181 mm / max. 5940)					
0,25	0,25	0,25	0,25	0,30	0,30
Surcharge per mm (min. 2181 mm / max. 5940)					
476,00	504,00	539,00	476,00	574,00	574,00
Surcharge per mm					
0,25	0,25	0,25	0,25	0,30	0,30

**36.327** do., incl. MUTO Comfort M 60 DORMOTION unit

\* For systems in special color (399) or in white (350), the end caps are supplied in plastic white or anthracite lacquered.

## Complete sets (optional with DORMOTION) for double-leaf glass doors (8-13.5 mm) or timber doors (28 -50 mm), installation at walls and ceilings

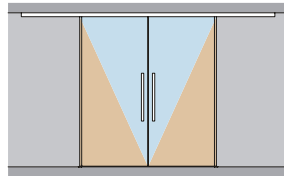
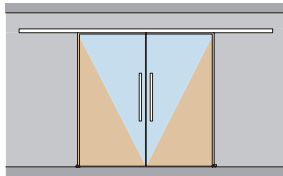

Art. No.	Description	AL anod Silver (150) €/Piece	AL anod sim. Stainl-Steel satin (157) €/Piece	AL p-coat Jet black (304) €/Piece	AL p-coat Traffic white (350) €/Piece	AL anod Special (199) €/Piece	AL p-coat Special color (399) * €/Piece
----------	-------------	------------------------------	-----------------------------------------------	-----------------------------------	---------------------------------------	-------------------------------	-----------------------------------------

For Timber door application the adapter profile 36.261 / 36.262 will be necessitated

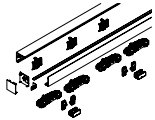

**MUTO Comfort L 80**  
**for two panels**  
**with max. 1250 mm panel width each**  
 consisting of:  
 1 track  
 1 cover profile  
 4 clamp carriers  
 (for 8-13.5 mm glass thickness) with anti-jump mechanism  
 4 endstops with safety catch and anti jump device  
 2 floor guides  
 2 end caps  
 incl. view protection brushes

**Individual lengths**  
**max. 5000 mm**

**Note:**  
 For individual lengths from 4361 mm, the price is composed of the basic price for 4360 mm profile length plus surcharge per additional mm (max 5000 mm)!

<b>36.323</b>	<b>Installation at wall</b>	Basic price for lengths up to 4360 mm					
		<b>727,00</b>	<b>783,00</b>	<b>853,00</b>	<b>727,00</b>	<b>923,00</b>	<b>923,00</b>
		plus Surcharge per mm (min. 4361 mm / max. 5000)					
		<b>0,25</b>	<b>0,25</b>	<b>0,25</b>	<b>0,25</b>	<b>0,30</b>	<b>0,30</b>
<b>36.324</b>	<b>Installation at ceiling</b>	Basic price for lengths up to 4360 mm					
		<b>727,00</b>	<b>783,00</b>	<b>853,00</b>	<b>727,00</b>	<b>923,00</b>	<b>923,00</b>
		plus Surcharge per mm (min. 4361 mm / max. 5000)					
		<b>0,25</b>	<b>0,25</b>	<b>0,25</b>	<b>0,25</b>	<b>0,30</b>	<b>0,30</b>
<b>do.</b>							
<b>incl. MUTO Comfort L 80 DORMOTION unit</b>							
<b>36.329</b>	<b>Installation at wall</b>	Basic price for lengths up to 4360 mm					
		<b>953,00</b>	<b>1009,00</b>	<b>1077,00</b>	<b>953,00</b>	<b>1147,00</b>	<b>1147,00</b>
		plus Surcharge per mm (min. 4361 mm / max. 5000)					
		<b>0,25</b>	<b>0,25</b>	<b>0,25</b>	<b>0,25</b>	<b>0,30</b>	<b>0,30</b>
<b>36.330</b>	<b>Installation at ceiling</b>	Basic price for lengths up to 4360 mm					
		<b>953,00</b>	<b>1009,00</b>	<b>1077,00</b>	<b>953,00</b>	<b>1147,00</b>	<b>1147,00</b>
		plus Surcharge per mm (min. 4361 mm / max. 5000)					
		<b>0,25</b>	<b>0,25</b>	<b>0,25</b>	<b>0,25</b>	<b>0,30</b>	<b>0,30</b>

\* For systems in special color (399) or in white (350), the end caps are supplied in plastic white or anthracite lacquered.

**Complete sets (optional with DORMOTION, Synchro) for glass doors (8-13.5 mm) or timber doors (28-50 mm), single- or double-leaf with glass overpanel and glass sidelights**

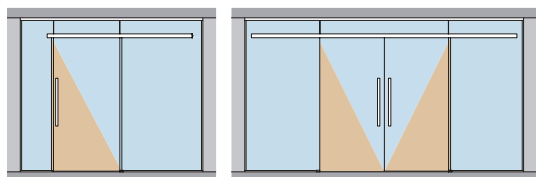

Art. No. Description

AL anod Silver (150)	AL anod sim. Stainl- Steel satin (157)	AL p-coat Jet black (304)	Al p-coat Traffic white (350)	AL anod Special (199)	AL p-coat Special color (399)  *
€/Piece	€/Piece	€/Piece	€/Piece	€/Piece	€/Piece

Sliding door fittings

**For Timber door application the adapter profile 36.261 / 36.262 will be necessitated**

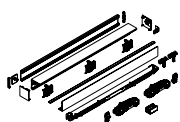

**MUTO Comfort L 80**  
for max. 2000 mm panel width  
consisting of:  
1 track  
1 cover profile  
1 counter profile  
2 clamp carriers  
(for 8–13.5 mm glass thickness) with anti-jump mechanism  
2 endstops with safety catch  
1 floor guide  
4 end caps  
incl. view protection brushes

**Defined lengths**

**max 2287 mm profile length  
single-leaf**

<b>36.304</b>	for 1050 mm clear opening, or 1110 mm panel width	<b>589,00</b>	<b>629,00</b>	<b>684,00</b>	<b>589,00</b>	<b>693,00</b>	<b>693,00</b>
<b>36.305</b>	for 1250 mm clear opening, or 1310 mm panel width	<b>735,00</b>	<b>806,00</b>	<b>876,00</b>	<b>735,00</b>	<b>888,00</b>	<b>888,00</b>

**Individual lengths**

**Note:**  
For individual lengths from 2288 mm, the price is composed of the basic price for 2287 mm profile length plus surcharge per additional mm (max 5012 mm)!

**max. 4067 mm profile length  
single-leaf**

<b>36.322</b>	for max. 1940 mm clear opening, or max. 2000 mm panel width	Basic price for lengths up to 2287 mm					
		<b>589,00</b>	<b>629,00</b>	<b>684,00</b>	<b>589,00</b>	<b>693,00</b>	<b>693,00</b>
		Surcharge per mm (min. 2288 mm / max. 4067)					
		<b>0,25</b>	<b>0,25</b>	<b>0,25</b>	<b>0,25</b>	<b>0,30</b>	<b>0,30</b>
<b>36.328</b>	do., incl. MUTO Comfort L 80 DORMOTION unit	Basic price for lengths up to 2287 mm					
		<b>700,00</b>	<b>743,00</b>	<b>797,00</b>	<b>700,00</b>	<b>806,00</b>	<b>806,00</b>
		Surcharge per mm (min. 2288 mm / max. 4067)					
		<b>0,25</b>	<b>0,25</b>	<b>0,25</b>	<b>0,25</b>	<b>0,30</b>	<b>0,30</b>

**max. 5012 mm profile length  
double-leaf**

<b>36.325</b>	for max. 2446 mm clear opening, or max. 1250 mm panel width each	Basic 4574 mm / Max. 5012 mm					
		<b>1175,00</b>	<b>1260,00</b>	<b>1370,00</b>	<b>1175,00</b>	<b>1385,00</b>	<b>1385,00</b>
		Surcharge per mm (min. 2288 mm / max. 5012)					
		<b>0,25</b>	<b>0,25</b>	<b>0,25</b>	<b>0,25</b>	<b>0,30</b>	<b>0,30</b>
<b>36.331</b>	do., incl. MUTO Comfort L 80 DORMOTION unit	Basic 4574 mm / Max. 5012 mm					
		<b>1400,00</b>	<b>1484,00</b>	<b>1594,00</b>	<b>1400,00</b>	<b>1610,00</b>	<b>1610,00</b>
		Surcharge per mm (min. 2288 mm / max. 5012)					
		<b>0,25</b>	<b>0,25</b>	<b>0,25</b>	<b>0,25</b>	<b>0,30</b>	<b>0,30</b>

**Please specify the clear width when you place your order.**

\* For systems in special color (399) or in white (350), the end caps are supplied in plastic white or anthracite lacquered.

**Glass door (8–13,5 mm) or timber door (28 - 50 mm), single or double-leaf, with glass sidelight, single and double sided, installation at ceiling**

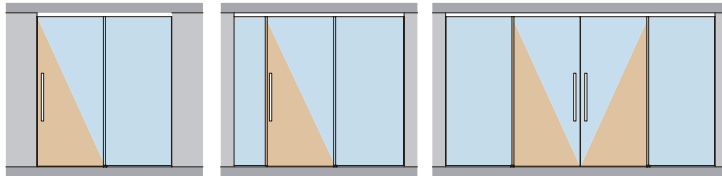

AL anod Silver (150)	AL anod sim. Stain-Steel satin (157)	AL p-coat Jet black (304)	AL p-coat Traffic white (350)	AL anod Special (199)	AL p-coat Special color (399)
€/Piece	€/Piece	€/Piece	€/Piece	€/Piece	€/Piece

Art. No. Description

**For Timber door application the adapter profile 36.261 / 36.262 will be necessitated**

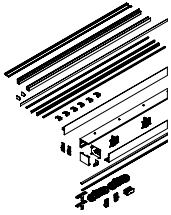

**Complete sets (optional with DORMOTION)**

**MUTO Comfort L 80**

**for max. 2000 mm panel width**

consisting of:

- 1 track
- 1 cover profile
- 1 sidelight profile
- 1 view protection profile depending on panel and sidelight
- 1 filling profile depending on panel and sidelight
- 2 or 4 clamp carriers (for 8–13.5 mm glass thickness) with anti-jump mechanism
- 2 or 4 endstops with safety catch and anti jump device
- 1 floor guide
- 2 end caps
- incl. view protection brushes

**Individual lengths**

**Note:**

**For individual lengths from 2288 mm, the price is composed of the basic price for 2287 mm profile length plus surcharge per additional mm (max 5012 mm)!**

**max. 4000 mm profile length**

**36.306 Single-leaf**  
for max. 2000 mm panel width,  
with 2 clamp carriers and 2 endstops

Basic price for lengths up to 2287 mm					
479,00	522,00	568,00	479,00	617,00	617,00
Surcharge per mm (min. 2288 mm / max. 4000)					
0,30	0,30	0,30	0,30	0,35	0,35

**max. 5940 mm profile length**

**36.365 Double-leaf,**  
with max. 1100 mm panel width each,  
with sidelights, 4 clamp carriers and 4 endstops

Basic price for lengths up to 4360 mm					
958,00	1045,00	958,00	1137,00	1231,00	1231,00
Surcharge per mm (min. 4361 mm / max. 5940)					
0,30	0,30	0,30	0,30	0,35	0,35





**Delivery condition of the sidelight profile:**

**within complete sets = pre-drilled**  
**as individual parts = undrilled**

VSG accessory set, status indicator and integrated lock can be found on page 78-79

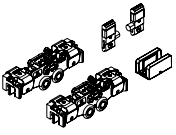
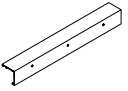
\* For systems in special color (399) or in white (350), the end caps are supplied in plastic white or anthracite lacquered.



## Single components MUTO Comfort L 80

Art. No.	Description	Base parts (000)	AL anod Silver (150)	AL anod sim. Stainl-Steel satin (157)	AL p-coat Jet black (304)	AL p-coat Traffic white (350)	AL anod Special (199)	AL p-coat Special color (399)
		€/Piece	€/Piece	€/Piece	€/Piece	€/Piece	€/Piece	€/Piece
	<b>MUTO Comfort L 80 timber adapter set</b> profile 12.5 x 36 mm, incl. accessory set (floor guide for timber door panel) 1460 mm							
36.261		61,00						
36.262	fixed length max. 2000 mm	€/m						
		77,00						
	<b>MUTO Comfort L 80 accessories set</b> consisting of: 2 clamp carriers 2 endstops 1 floor guide		232,00	232,00	238,00	238,00		
	<b>Track</b> <b>Installation at wall</b> stock length 6000 mm		287,00	333,00	343,00	287,00	399,00	399,00
36.350		€/m	€/m	€/m	€/m	€/m	€/m	€/m
36.351	fixed length	60,00	69,50	72,00	60,00	83,00	83,00	
	<b>Installation at ceiling</b> stock length 6000 mm		287,00	333,00	343,00	287,00	399,00	399,00
36.352		€/m	€/m	€/m	€/m	€/m	€/m	€/m
36.353	fixed length	60,00	69,50	72,00	60,00	83,00	83,00	
	<b>Cover profile</b> stock length 6000 mm		112,00	128,00	134,00	112,00	155,00	155,00
36.359		€/m	€/m	€/m	€/m	€/m	€/m	€/m
36.360	fixed length	23,50	26,50	28,00	23,50	32,00	32,00	
	<b>Set of end caps</b> for installation at wall and ceiling Plastic, white (350) Plastic, anthracite lacquered (399)		14,00	14,00		14,00		14,00
36.354								
	<b>MUTO Comfort L 80 set of end caps</b> for side panel profile, 58 mm height Plastic, white (350) Plastic, anthracite lacquered (399)		14,00	14,00		14,00	14,00	14,00
36.273								
	<b>Set of view protection brushes</b> for Comfort M, L and Premium XL consisting of: 1 view protection brush 8-10 mm glass thickness 1 view protection brush 12-13.5 mm glass thickness	€/m	12,50					
36.265								
	<b>Side panel profile 58 mm height,</b> with all gaskets, for 8-13,5 mm glass thickness stock length 6000 mm		140,00	158,00		140,00	192,00	192,00
36.271		€/m	€/m		€/m	€/m	€/m	€/m
36.274	fixed length	28,50	33,50		28,50	40,50	40,50	

VSG accessory set, status indicator and integrated lock can be found on page 78-79

\* For systems in special color (399) or in white (350), the end caps are supplied in plastic white or anthracite lacquered.

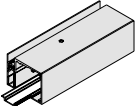
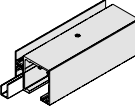
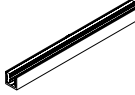
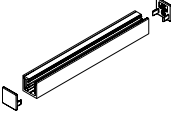
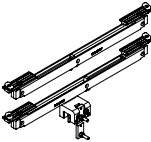
## Single components MUTO Comfort L 80

Art. No.	Description	Base parts (000)	AL anod Silver (150)	AL anod sim. Stainl-Steel satin (157)	AL p-coat Jet black (304)	AL p-coat Traffic white (350)	AL anod Special (199)	AL p-coat Special color (399)
		€/Piece	€/Piece	€/Piece	€/Piece	€/Piece	€/Piece	€/Piece
	<b>View protection profile</b> for Comfort L, Premium XL and Premium Self-Closing, for side panel profile stock length 6000 mm							
 36.800		83,00	95,50	98,50	83,00	114,00	114,00	
36.801	fixed length	€/m	€/m	€/m	€/m	€/m	€/m	€/m
		17,50	20,00	21,00	17,50	24,00	24,00	
	<b>MUTO Filling profile</b> for Comfort L, Premium XL and Premium Self-Closing stock length 6000 mm							
 36.802		83,00	95,50	98,50	83,00	114,00	114,00	
36.803	fixed length	€/m	€/m	€/m	€/m	€/m	€/m	€/m
		17,50	20,00	21,00	17,50	24,00	24,00	
	<b>Floor profile</b> incl. 2 end caps for Comfort L, Premium XL and Premium Self-Closing, for side panel fixing, complete with all gaskets, for 8-13,5 mm glass thickness stock length 6000 mm							
 36.810		142,00	163,00	170,00	142,00	197,00	197,00	
36.811	fixed length	€/m	€/m	€/m	€/m	€/m	€/m	€/m
		29,50	34,00	35,50	29,50	41,00	41,00	
 36.812	<b>end caps (2 pcs.)</b> for Comfort L, Premium XL and Premium Self-Closing for floor profile – sidelight fixing Plastic, white (350) Plastic, anthracite lacquered (399)	9,80	9,80		9,80		9,80	9,80
	<b>optionally retrofittable</b>							
 36.361	<b>DORMOTION unit, Version 2021</b> for max. 80 kg, incl. starter min. panel width 600 mm max. panel width 2000 mm	112,00						
 36.357	<b>MUTO Comfort L 80 Synchro-Set</b> for max. 80 kg consisting of: 1 elastic rope 2 deflexion roller	313,00						
	<b>Track</b> installation at glass (incl. gaskets) stock length 6000 mm							
36.363		287,00	333,00	343,00	287,00	399,00	399,00	
36.364	fixed length	€/m	€/m	€/m	€/m	€/m	€/m	€/m
		60,00	69,50	72,00	60,00	83,00	83,00	
	<b>Counter profile</b> <b>installation at glass</b> (incl. fixing plates - 2 pieces/m - and gaskets) stock length 6000 mm							
36.218		192,00	221,00	229,00	192,00	266,00	266,00	
36.219	fixed length	€/m	€/m	€/m	€/m	€/m	€/m	€/m
		41,50	47,00	50,00	41,50	58,00	58,00	
36.145	<b>Fixing plates, installation at glass</b> (2 Pieces)	8,80						
36.260	<b>Set of end caps</b> for counter profile Plastic, white (350) Plastic, anthracite lacquered (399)	14,00	14,00		14,00			

VSG accessory set, status indicator and integrated lock can be found on page 78-79

\* For systems in special color (399) or in white (350), the end caps are supplied in plastic white or anthracite lacquered.

## Notes



# MUTO Comfort L 80 Pocket

## Ceiling slot / Wall pocket

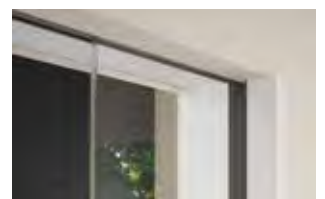

Technical data	
Glass	TSG, LSG (2 x TSG)
Glass door thickness	8-13,5 mm
Timber door thickness	Ceiling slot solution without wall pocket 28 - 50 mm / Wall pocket solution 28 - 40 mm
Max. door weight	80 kg
Application	Application single-leaf, double-leaf (glass or timber doors), glass sidelights
Material	Aluminium
Finishes	Anodized- and RAL-Colors (coated)
Kind of installation	recessed into ceiling slot and / or wall pocket
Specials	DORMOTION unit in opening and closing direction or DORMOTION unit in closing direction with Push-to-open unit in opening direction Tested acc. DIN EN 1527 Height readjustable without dismantling +5/-3 mm

Example view for MUTO Comfort L 80 Pocket, door (1- / 2-panels), recessed into ceiling slot

Sliding door fittings

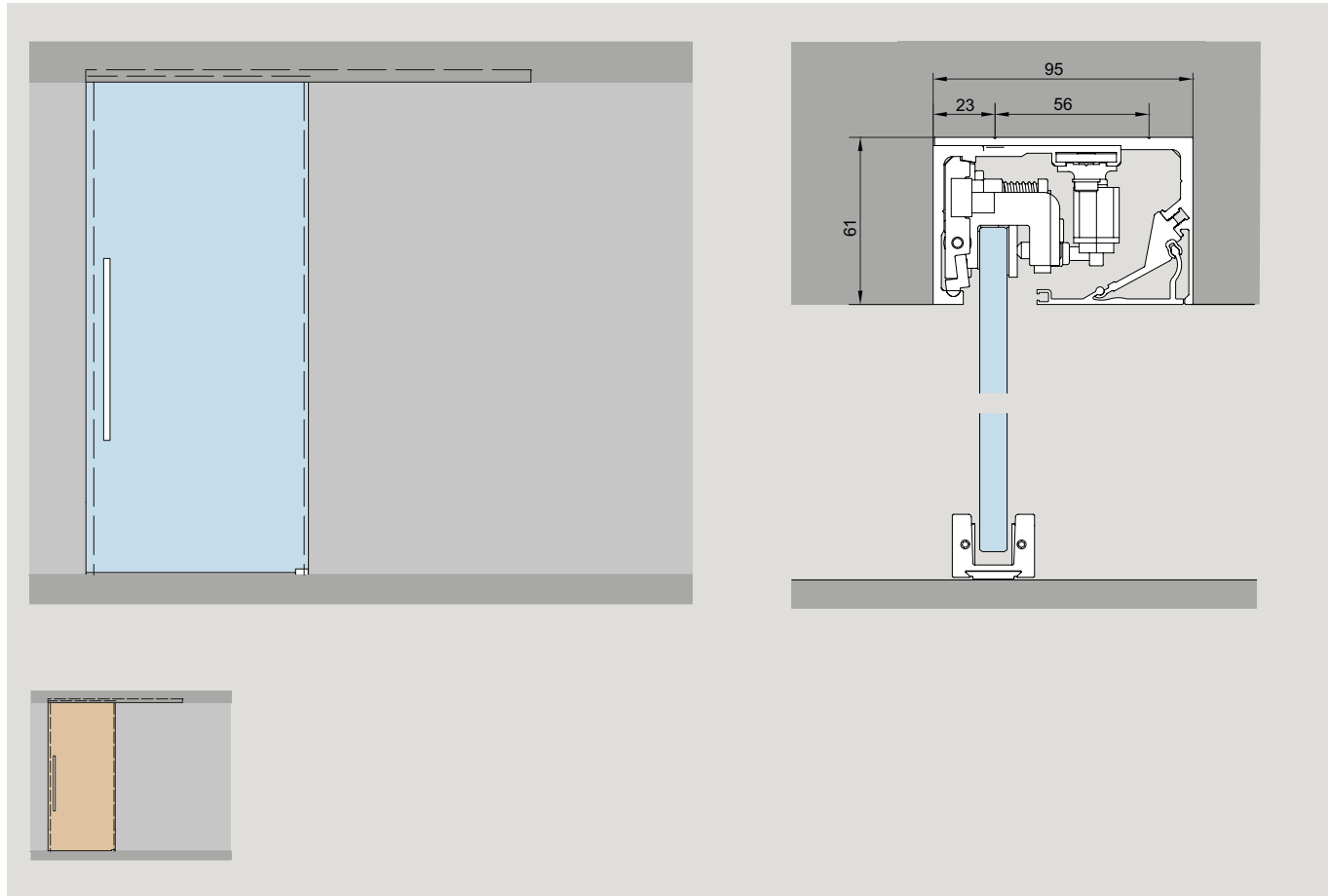

Example view for MUTO Comfort L 80 Pocket, door (1- / 2-panels) and side panel(s), recessed into ceiling slot

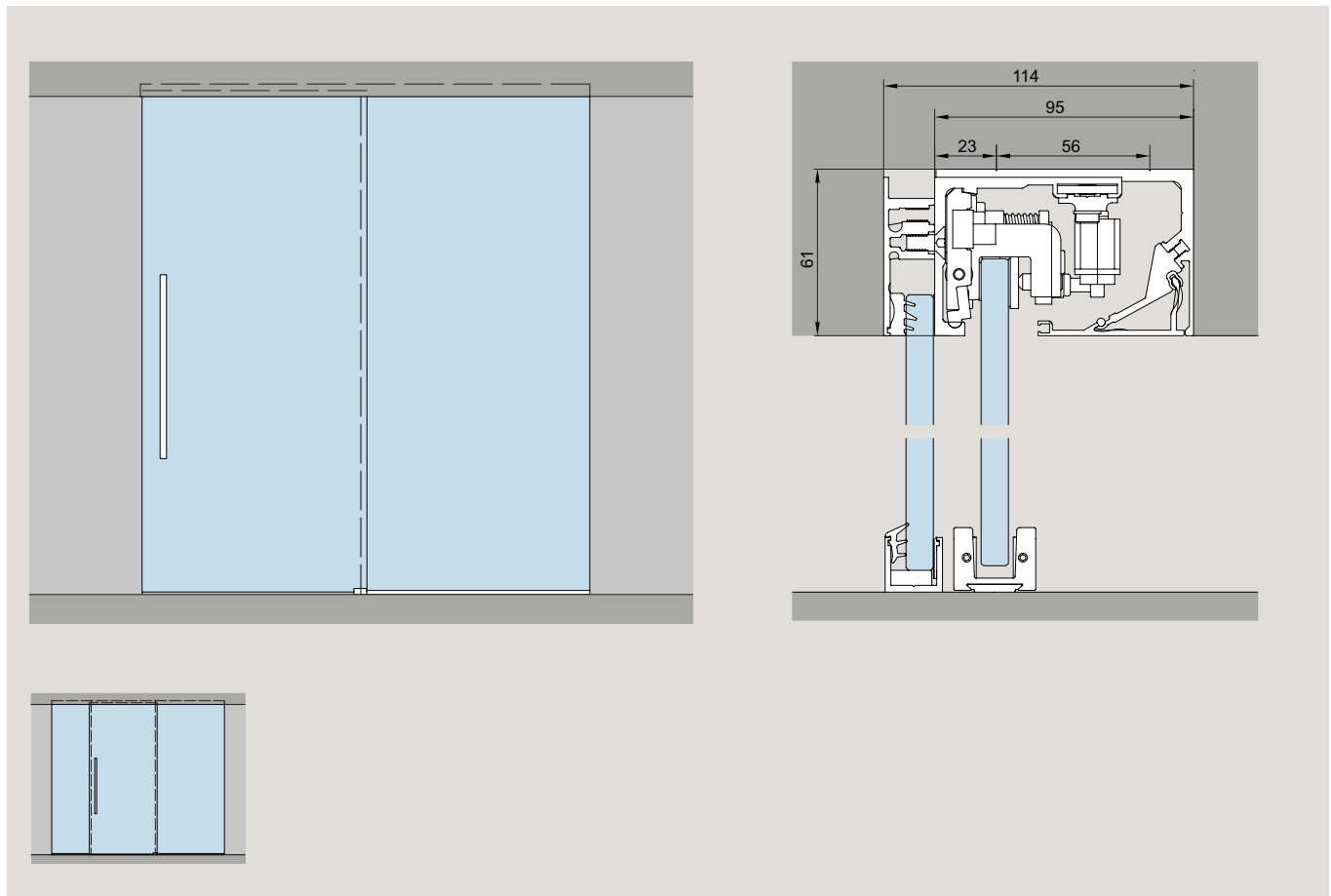

**Example view for MUTO Comfort L 80 Pocket, 1 or 2 panel door, movable into wall pocket  
Ceiling slot installation**

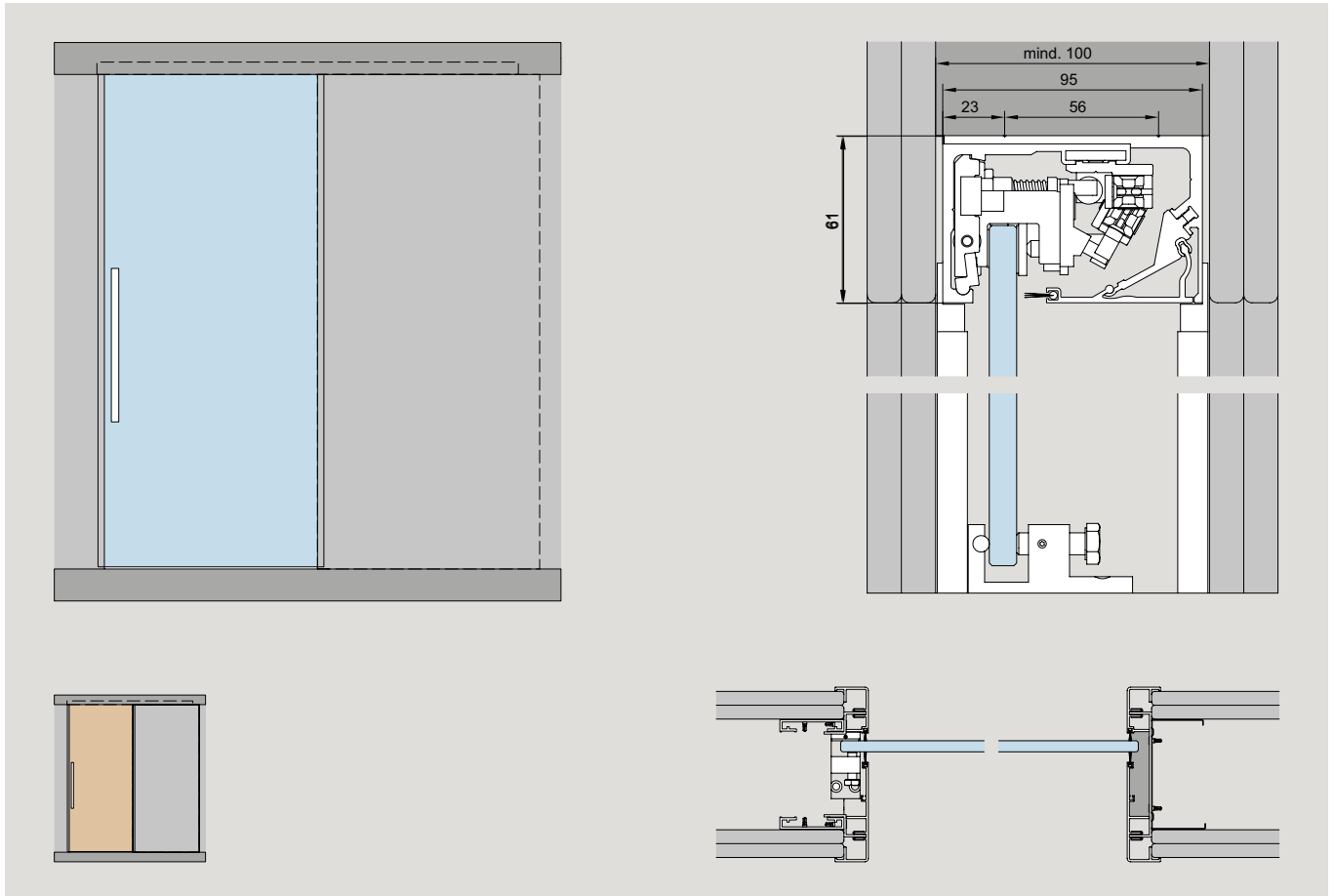

Sliding door fittings

**Example view for MUTO Comfort L 80 Pocket, 1 or 2 panel door, with side panel, door movable into wall pocket  
Ceiling slot installation**

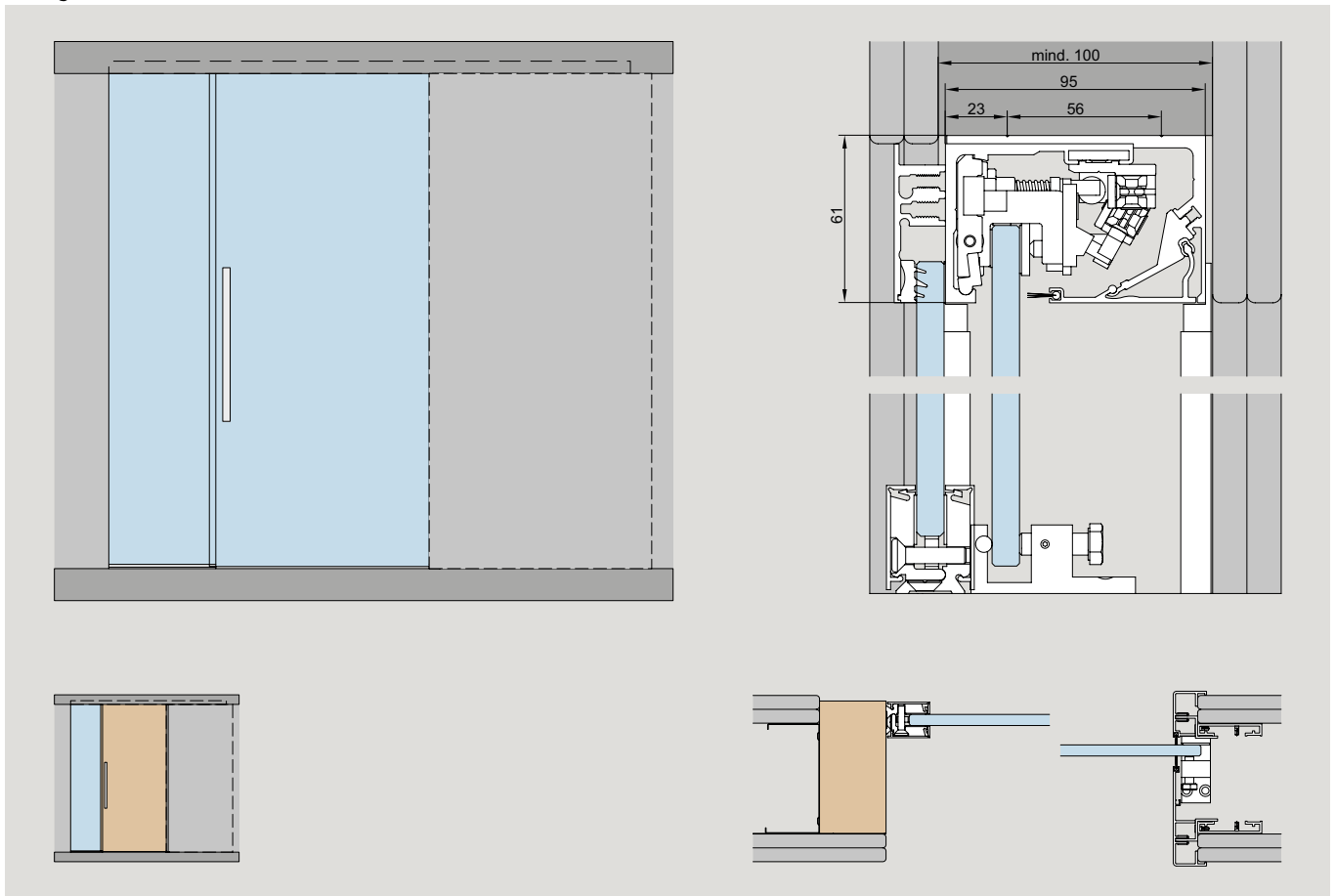

**Complete sets for glass doors (8 - 13,5 mm, max 80 kg), timber doors (28 - 50 mm), single and double leaf, with and without sidelight, installation in ceiling slot**

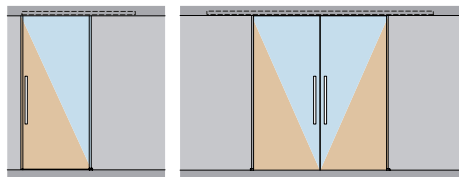

Art. No. Description

Base parts (000)	AL anod Silver (150)	AL anod sim. Stainl-Steel satin (157)	Al p-coat Traffic white (350)	AL anod Special (199)	AL p-coat Special color (399)
€/Piece	€/Piece	€/Piece	€/Piece	€/Piece	€/Piece

For Timber door application the adapter profile 36.261 / 36.262 will be necessitated

**MUTO Comfort L 80 Pocket**  
Set for ceiling slot installation, for 750 mm panel width, profile length 1500 mm, incl. DORMOTION unit on both sides, incl. all profiles and complete accessory

**Without sidelight**

For single leaf doors

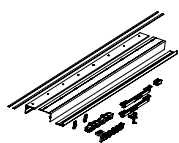

36.230	for 750 mm panel width, profile length 1500 mm	587,00	650,00	587,00	653,00	653,00
36.231	for 1000 mm panel width, profile length 2000 mm	666,00	752,00	666,00	756,00	756,00

36.232	Profile in fixed length max. 4000 mm, prepared for panel overlapping on both sides	666,00	752,00	666,00	756,00	756,00
--------	------------------------------------------------------------------------------------	--------	--------	--------	--------	--------

Basic 2000 mm

Surcharge per mm

0,30	0,30	0,30	0,36	0,36
------	------	------	------	------

Basic 2000 mm

Surcharge per mm

0,30	0,30	0,30	0,36	0,36
------	------	------	------	------

36.240	prepared for panel overlapping on one side	666,00	752,00	666,00	756,00	756,00
--------	--------------------------------------------	--------	--------	--------	--------	--------

For 2-leaf doors without sidelight

36.233	for 2 x 750 mm panel width, profile length 3000 mm	1129,00	1317,00	1129,00	1324,00	1324,00
36.234	for 2 x 1000 mm panel width, profile length 4000 mm	1302,00	1479,00	1302,00	1490,00	1490,00

36.235	Profile in fixed length max. 6000 mm	1302,00	1479,00	1302,00	1490,00	1490,00
--------	--------------------------------------	---------	---------	---------	---------	---------

Basic 4000 mm

Surcharge per mm

0,30	0,30	0,30	0,36	0,36
------	------	------	------	------

**With sidelight**

For 1-leaf doors with side panel on one side

36.243	prepared for panel overlapping on one side	765,00	909,00	765,00	918,00	918,00
--------	--------------------------------------------	--------	--------	--------	--------	--------

Basic 2000 mm

Surcharge per mm

0,35	0,35	0,35	0,40	0,40
------	------	------	------	------

Basic 2000 mm

Surcharge per mm

0,35	0,35	0,35	0,40	0,40
------	------	------	------	------

36.275	prepared for panel overlapping on both sides	765,00	909,00	765,00	918,00	918,00
--------	----------------------------------------------	--------	--------	--------	--------	--------

For 1-leaf doors with side panel on both side

36.276	prepared for panel overlapping on both sides	982,00	1107,00	982,00	1120,00	1111,00
--------	----------------------------------------------	--------	---------	--------	---------	---------

Basic 3000 mm

Surcharge per mm

0,35	0,35	0,35	0,40	0,40
------	------	------	------	------

Basic 4000 mm

Surcharge per mm

0,35	0,35	0,35	0,40	0,40
------	------	------	------	------

36.244	For 2-leaf doors with side panel	1595,00	1800,00	1595,00	1813,00	1813,00
--------	----------------------------------	---------	---------	---------	---------	---------

**Complete sets for glass doors (8 - 13,5 mm, max 80 kg), timber doors (28 - 50 mm), single and double leaf, with and without sidelight, door movable into wall pocket**

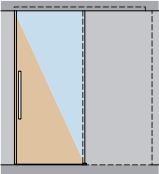
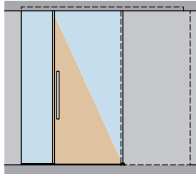
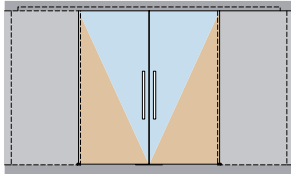
				Base parts (000)	AL anod Silver (150)	AL anod sim. Stainl-Steel satin (157)	Al p-coat Traffic white (350)	AL anod Special (199)	AL p-coat Special color (399)	*
Art. No.	Description	DIN	€/Piece	€/Piece	€/Piece	€/Piece	€/Piece	€/Piece	€/Piece	

For timber door application the adapter profile 36.346 will be necessitated

Complete sets for doors with 8 - 13.5 mm glass thickness, max. 80 kg

**MUTO Comfort L 80 Pocket**  
Sliding door set for wall pocket installation incl. DORMOTION units on both sides incl. all profiles and accessories

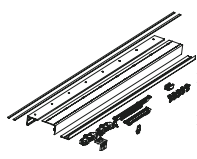

36.236	Door panel width 750 mm	RH	598,00	661,00	598,00	665,00	665,00
36.237		LH	598,00	661,00	598,00	665,00	665,00
36.238	Door panel width 1000 mm	RH	679,00	764,00	679,00	770,00	770,00
36.239		LH	679,00	764,00	679,00	770,00	770,00
36.245	Door panel width fixed dimension	RH	Basic 2000 mm 679,00 Surcharge per mm 0,30	Basic 2000 mm 764,00 Surcharge per mm 0,30	Basic 2000 mm 679,00 Surcharge per mm 0,30	Basic 2000 mm 770,00 Surcharge per mm 0,36	Basic 2000 mm 770,00 Surcharge per mm 0,36
36.246		LH	Basic 2000 mm 679,00 Surcharge per mm 0,30	Basic 2000 mm 764,00 Surcharge per mm 0,30	Basic 2000 mm 679,00 Surcharge per mm 0,30	Basic 2000 mm 770,00 Surcharge per mm 0,36	Basic 2000 mm 770,00 Surcharge per mm 0,36
36.247	Door panel width fixed dimension + sidelight	RH	Basic 2000 mm 778,00 Surcharge per mm 0,35	Basic 2000 mm 921,00 Surcharge per mm 0,35	Basic 2000 mm 778,00 Surcharge per mm 0,35	Basic 2000 mm 930,00 Surcharge per mm 0,40	Basic 2000 mm 930,00 Surcharge per mm 0,40
36.248		LH	Basic 2000 mm 778,00 Surcharge per mm 0,35	Basic 2000 mm 921,00 Surcharge per mm 0,35	Basic 2000 mm 778,00 Surcharge per mm 0,35	Basic 2000 mm 930,00 Surcharge per mm 0,40	Basic 2000 mm 930,00 Surcharge per mm 0,40
36.249	Double leaf door fixed dimension		Basic 4000 mm 1325,00 Surcharge per mm 0,30	Basic 4000 mm 1503,00 Surcharge per mm 0,30	Basic 4000 mm 1325,00 Surcharge per mm 0,30	Basic 4000 mm 1515,00 Surcharge per mm 0,36	Basic 4000 mm 1515,00 Surcharge per mm 0,36

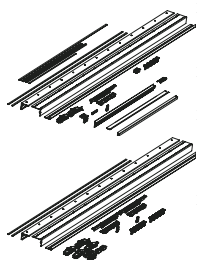

**MUTO Comfort L 80 Pocket**  
Sliding door set for wall pocket installation incl. DORMOTION unit in closing direction and Push-to-open unit in opening direction incl. all profiles and accessories

36.164	Door panel width 750 mm	RH	620,00	683,00	620,00	687,00	687,00
36.160		LH	620,00	683,00	620,00	687,00	687,00
36.165	Door panel width 1000 mm	RH	700,00	785,00	700,00	790,00	790,00
36.161		LH	700,00	785,00	700,00	790,00	790,00
36.166	Door panel width fixed dimension	R	Basic 2000 mm 700,00 Surcharge per mm 0,30	Basic 2000 mm 785,00 Surcharge per mm 0,30	Basic 2000 mm 700,00 Surcharge per mm 0,30	Basic 2000 mm 790,00 Surcharge per mm 0,36	Basic 2000 mm 790,00 Surcharge per mm 0,36
36.162		L	Basic 2000 mm 700,00 Surcharge per mm 0,30	Basic 2000 mm 785,00 Surcharge per mm 0,30	Basic 2000 mm 700,00 Surcharge per mm 0,30	Basic 2000 mm 790,00 Surcharge per mm 0,36	Basic 2000 mm 790,00 Surcharge per mm 0,36
36.167	Door panel width fixed dimension + sidelight	R	Basic 2000 mm 800,00 Surcharge per mm 0,35	Basic 2000 mm 944,00 Surcharge per mm 0,35	Basic 2000 mm 800,00 Surcharge per mm 0,35	Basic 2000 mm 953,00 Surcharge per mm 0,40	Basic 2000 mm 953,00 Surcharge per mm 0,40
36.163		L	Basic 2000 mm 800,00 Surcharge per mm 0,35	Basic 2000 mm 944,00 Surcharge per mm 0,35	Basic 2000 mm 800,00 Surcharge per mm 0,35	Basic 2000 mm 953,00 Surcharge per mm 0,40	Basic 2000 mm 953,00 Surcharge per mm 0,40
36.168	Double leaf door fixed dimension		Basic 4000 mm 1370,00 Surcharge per mm 0,30	Basic 4000 mm 1548,00 Surcharge per mm 0,30	Basic 4000 mm 1370,00 Surcharge per mm 0,30	Basic 4000 mm 1558,00 Surcharge per mm 0,36	Basic 4000 mm 1558,00 Surcharge per mm 0,36

## Profile kits for wall pocket construction for glass doors (8 - 13.5 mm) and for timber doors (28 - 40 mm)

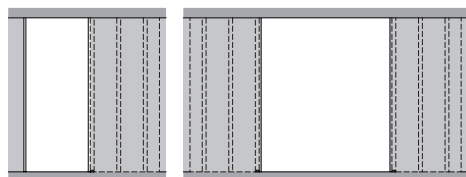

AL anod Silver (150)	AL anod sim. Stain- Steel satin (157)	Al p-coat Traffic white (350)	AL anod Special (199)	AL p-coat Special color (399) *
-------------------------------	---------------------------------------------------------	-------------------------------------------	--------------------------------	------------------------------------------------

Art. No. Description

**Profile kits for wall pocket construction**  
incl. 2 x vertikale profiles with brush sealings and special floor guide  
- integrated into wall pocket  
(designed for usual dry-wall constructions of 100 mm inner and  
150 mm outer dimension.)

**MUTO Comfort L 80 Pocket**  
Profile kit for wall pocket construction for glass doors,  
door height up to 2250 mm

	36.284	Door panel width ≤ 750 mm	829,00	964,00	829,00	973,00	973,00
	36.285	Door panel width > 750 mm (max. 1.500 mm)	894,00	1029,00	894,00	1040,00	1040,00

	36.286	Double leaf door, panel width ≤ 750 mm	881,00	1015,00	881,00	1024,00	1024,00
	36.287	Double leaf door, panel width > 750 mm (max. 1.500 mm)	947,00	1082,00	947,00	1093,00	1093,00

**MUTO Comfort L 80 Pocket**  
Profile kit for wall pocket construction  
for glass doors, door height up to 2251 - 2800 mm

	36.280	Door panel width ≤ 750 mm	986,00	1119,00	986,00	1131,00	1131,00
	36.281	Door panel width > 750 mm (max. 1.500 mm)	1052,00	1186,00	1052,00	1197,00	1197,00

	36.282	Double leaf door, panel width ≤ 750 mm	1039,00	1171,00	1039,00	1184,00	1184,00
	36.283	Double leaf door, panel width > 750 mm (max. 1.500 mm)	1105,00	1236,00	1105,00	1250,00	1250,00

**MUTO Comfort L 80 Pocket**  
Profile kit for wall pocket construction  
for timber doors, door height up to 2250 mm  
incl. adapter profile and floor guide for timber doors

	36.288	Door panel width ≤ 750 mm	1004,00	1105,00	1004,00	1115,00	1115,00
	36.289	Door panel width > 750 mm (max. 1.500 mm)	1067,00	1168,00	1067,00	1179,00	1179,00





	36.290	Double leaf door panel width ≤ 750 mm	1082,00	1184,00	1082,00	1194,00	1194,00
	36.291	Double leaf door panel width > 750 mm (max. 1.500 mm)	1146,00	1247,00	1146,00	1258,00	1258,00

**MUTO Comfort L 80 Pocket**  
Profile kit for wall pocket construction  
for timber doors, door height 2251 - 2800 mm  
incl. adapter profile and floor guide for timber doors

	36.292	Door panel width ≤ 750 mm	1161,00	1260,00	1161,00	1273,00	1273,00
	36.293	Door panel width > 750 mm (max. 1.500 mm)	1224,00	1324,00	1224,00	1339,00	1339,00

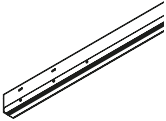
	36.294	Double leaf door panel width ≤ 750 mm	1239,00	1339,00	1239,00	1351,00	1351,00
	36.295	Double leaf door panel width > 750 mm (max. 1.500 mm)	1304,00	1401,00	1304,00	1416,00	1416,00

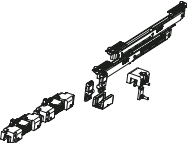
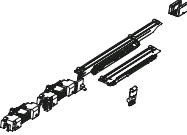
## Single components MUTO Comfort L 80 Pocket

Art. No.	Description	DIN	Base parts	AL	AL	Al	AL	AL
			(000)	anod Silver (150)	anod sim. Stainl-Steel satin (157)	p-coat Traffic white (350)	anod Special (199)	p-coat Special color (399)
			€/Piece	€/Piece	€/Piece	€/Piece	€/Piece	€/Piece
<p><b>Single components applicable in combination with MUTO Comfort L 80 track profile Art No. 36.350 / 36.351</b></p>								
	<b>36.332</b> Pocket profile Stock length 6000 mm		287,00	333,00	287,00	366,00	366,00	
	36.333 Fixed lengths		€/m 60,00	€/m 69,50	€/m 60,00	€/m 75,50	€/m 75,50	
	<b>36.334</b> Cover profile Stock length 6000 mm		112,00	128,00	112,00	139,00	139,00	
	36.335 Fixed lengths		€/m 23,50	€/m 26,50	€/m 23,50	€/m 28,50	€/m 28,50	
	<b>36.442</b> Fixing clips for bottom cover profile fixing (5 Pcs.)		13,50					
	<b>36.338</b> Accessory set for ceiling slot solution		355,00	355,00	355,00	355,00	355,00	
	<b>36.340</b> Accessory set for wall pocket solution complete incl. 2 x DORMOTION unit	RH	366,00					
	<b>36.341</b>	LH	366,00					
	<b>36.342</b> Accessory set for wall pocket solution complete incl. 1 x DORMOTION unit and 1 x Push-to-open unit	RH	388,00					
	<b>36.343</b>	LH	388,00					
	<b>36.440</b> Installation support set (2 brackets)		27,00					

## Notes



# MUTO Premium XL 80 / 150



Technical data	
Glass	TSG, LSG (from 2 x TSG)
glass thickness	8–13,5 mm
Max. door weight	80 kg/150 kg
Applications	single-leaf, double-leaf, (glass or timber leaves), glass sidelights, at glass
Material	Aluminium
Finishes	Anodized- and RAL-Colors (coated)
Kind of installation	Wall, ceiling and at glass
Specials	DORMOTION integrated locking mechanism and status indicator are optionally retrofittable For double leaf assemblies Synchro is optionally retrofittable Tested acc. DIN EN 1527:2020-04 Height readjustable without dismantling +/-5 mm

Example view for MUTO Premium XL 80/150 installation at wall

Sliding door fittings

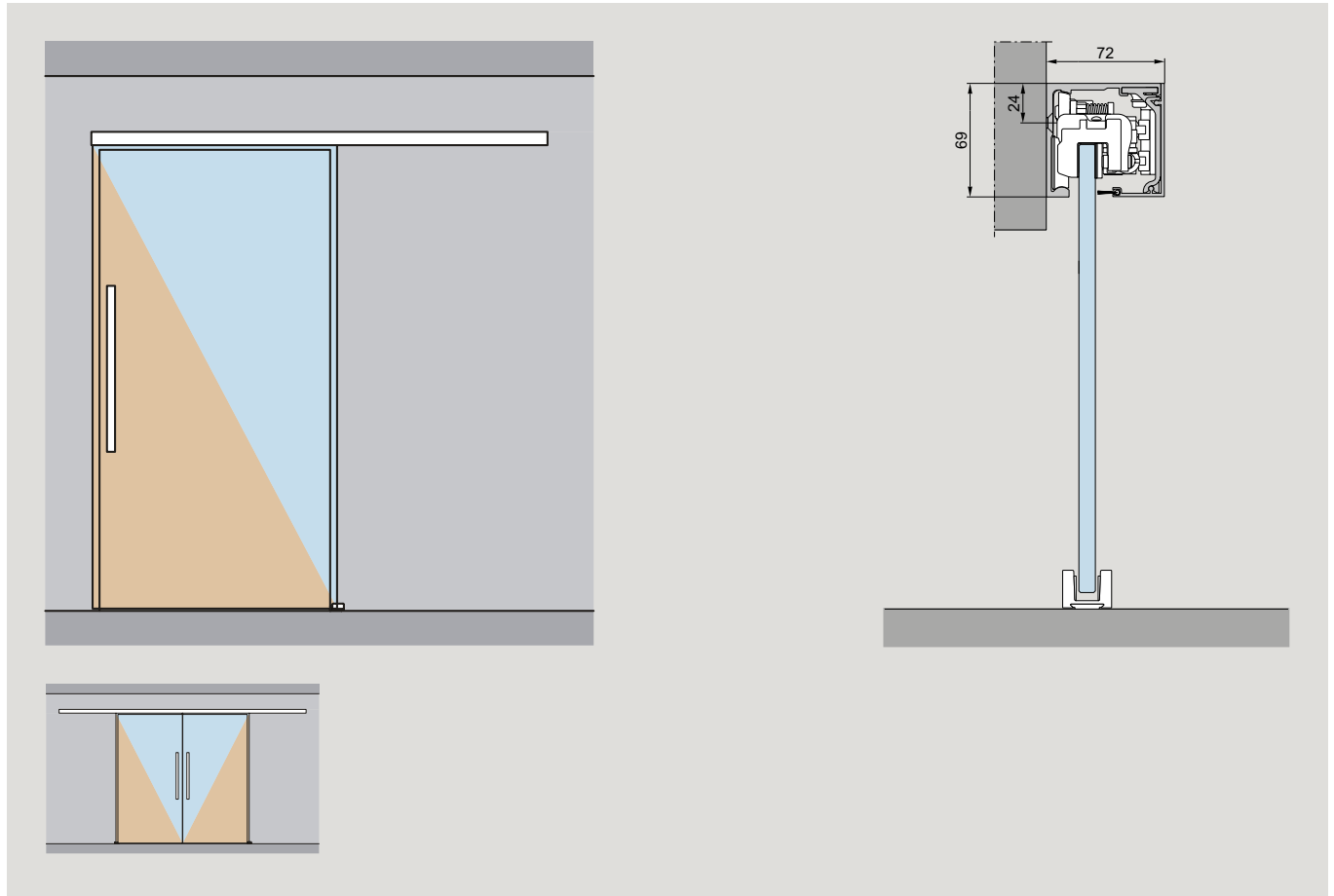

Example view for MUTO Premium XL 80/150 Installation at ceiling

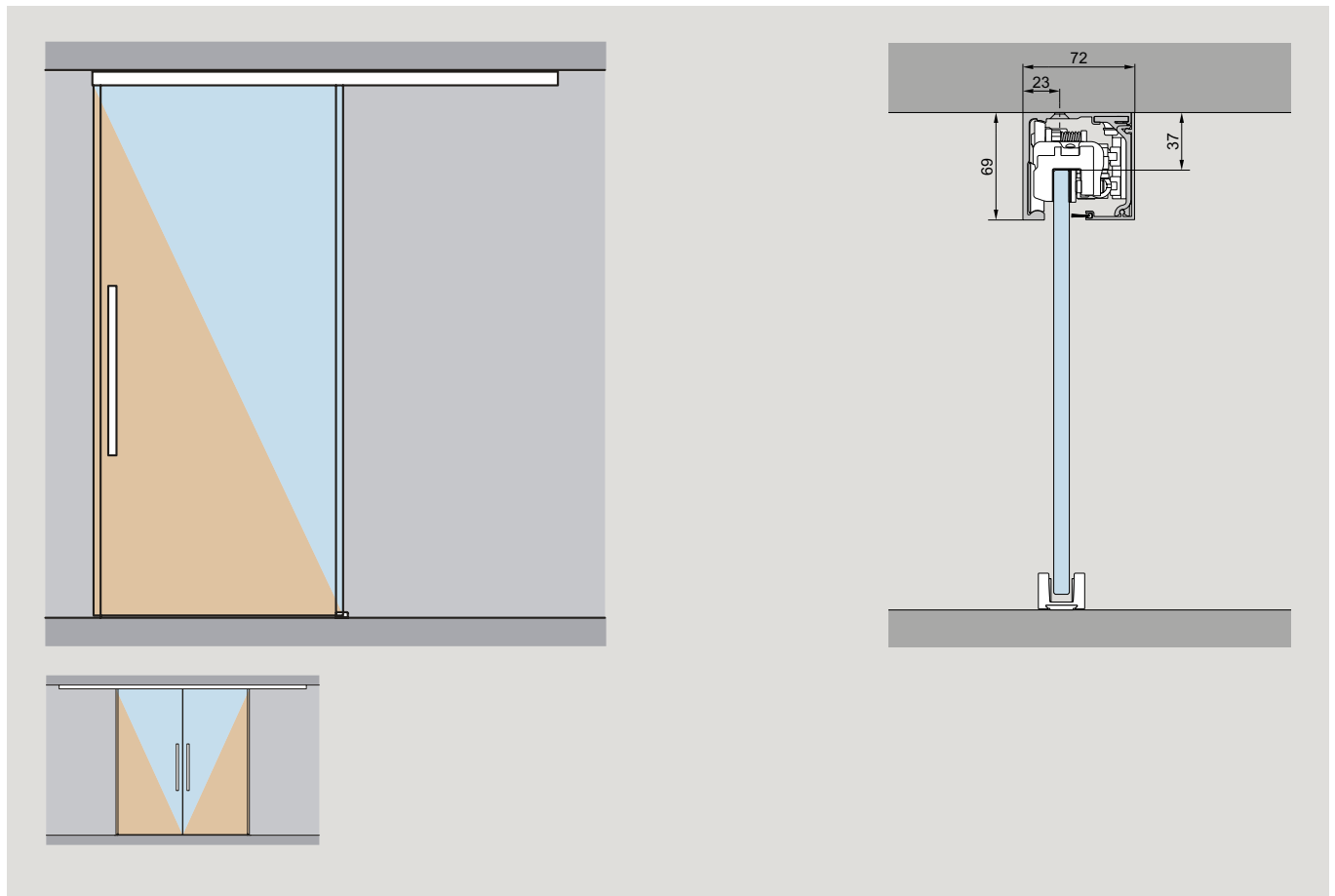

Example view for MUTO Premium XL 80/150 with glass sidelight/s

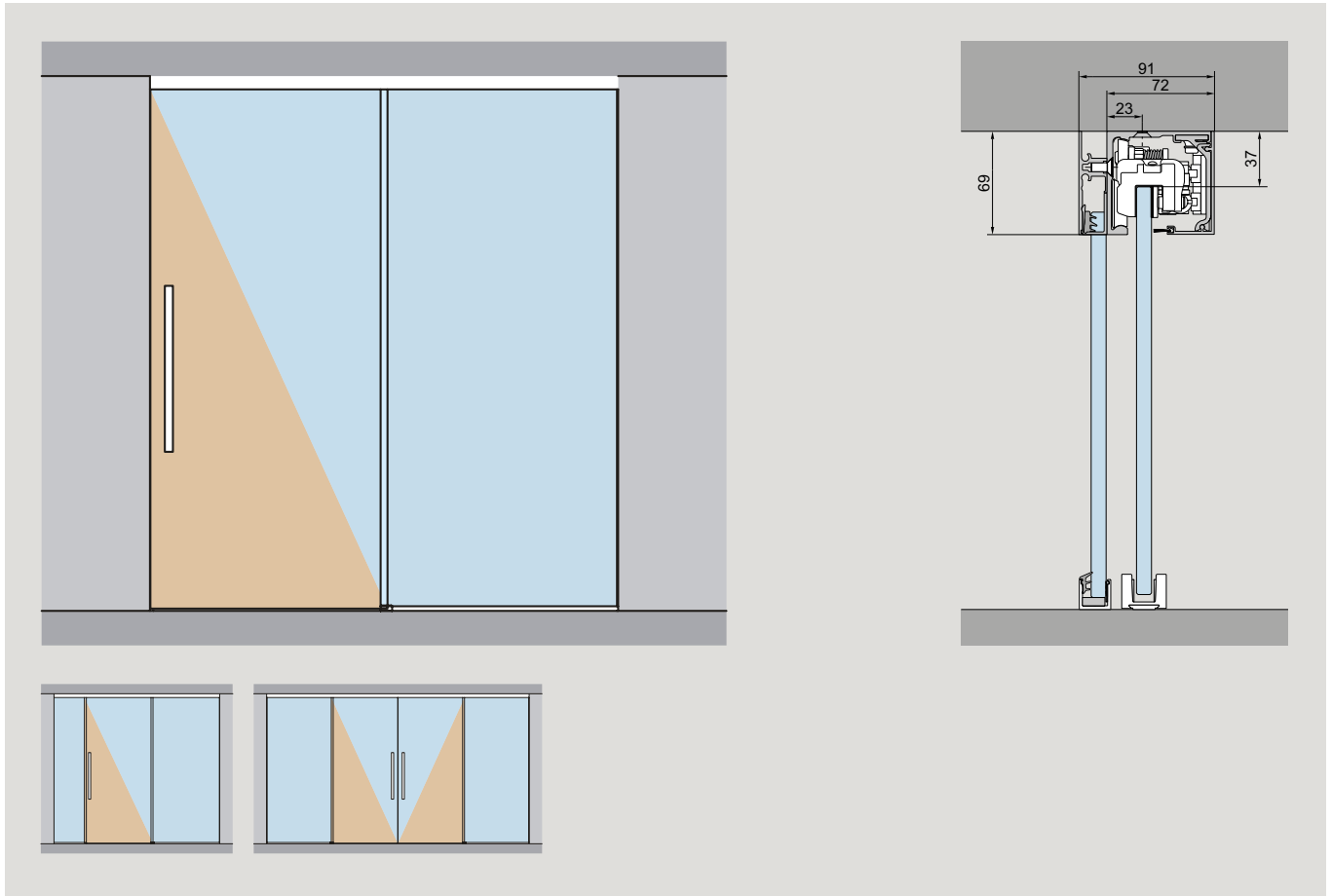

Sliding door fittings

Example view for MUTO Premium XL 80/150 with glass overpanel and glass sidelights

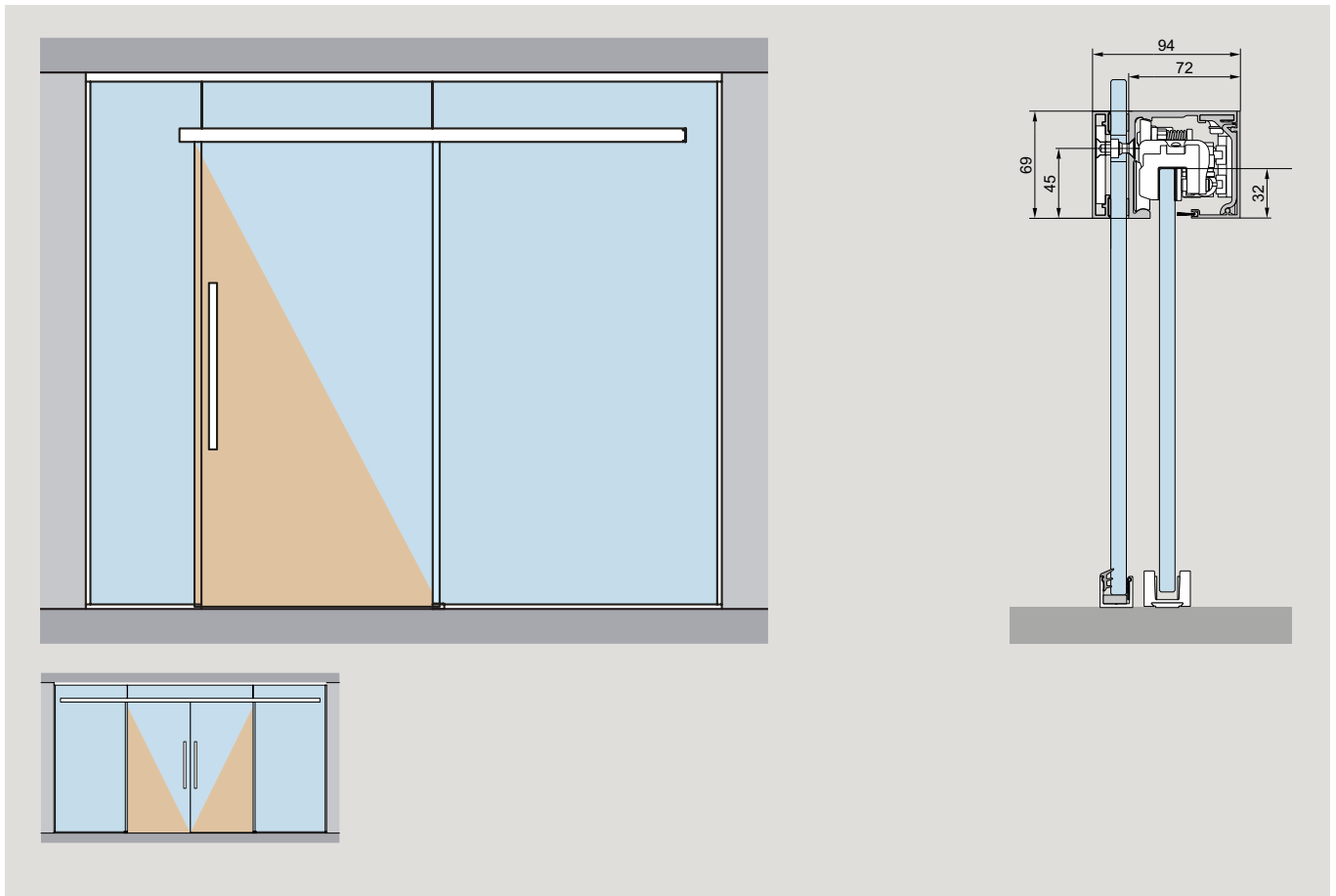

**Complete sets (inclusive DORMOTION) for glass door (8–13,5 mm) or timber door (28 - 50 mm), single-leaf, installation at wall or ceiling**

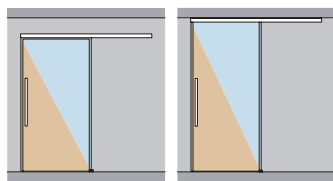

Art. No. Description

AL anod Silver (150)	AL anod sim. Stainl- Steel satin (157)	AL p-coat Jet black (304)	AL p-coat Traffic white (350)	AL anod Special (199)	AL p-coat Special color (399) *
€/Piece	€/Piece	€/Piece	€/Piece	€/Piece	€/Piece

**For Timber door application the adapter profile 36.461 / 36.464 will be necessitated**

**MUTO Premium XL 80/150**

consisting of:  
 1 track profile  
 1 cover profile  
 2 clamp carriers  
 (for 8–13.5 mm glass thickness) with anti-jump mechanism  
 2 endstops with safety catch and anti jump device  
 1 floor guide  
 2 end caps  
 incl. brush profile  
 1 DORMOTION unit 2021

**Defined lengths**

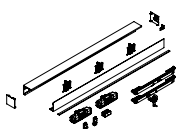

**max. 80 kg, incl. DORMOTION XL – 80 for installation at wall**

36.500	900 mm panel width/1780 mm profile length	727,00	783,00	836,00	727,00	940,00	940,00
36.501	1200 mm panel width/2380 mm profile length	829,00	902,00	963,00	829,00	1082,00	1082,00
36.502	1450 mm panel width/2880 mm profile length	911,00	997,00	1066,00	911,00	1198,00	1198,00

**for installation at ceiling**

36.503	900 mm panel width/1780 mm profile length	727,00	783,00	836,00	727,00	940,00	940,00
36.504	1200 mm panel width/2380 mm profile length	829,00	902,00	963,00	829,00	1082,00	1082,00
36.505	1450 mm panel width/2880 mm profile length	911,00	997,00	1066,00	911,00	1198,00	1198,00

**max. 150 kg, incl. DORMOTION XL – 150 for installation at wall**

36.509	1250 mm panel width/2480 mm profile length	895,00	953,00	1015,00	895,00	1142,00	1142,00
36.510	1450 mm panel width/2880 mm profile length	962,00	1030,00	1100,00	962,00	1235,00	1235,00

**for installation at ceiling**

36.511	1250 mm panel width/2480 mm profile length	895,00	953,00	1015,00	895,00	1142,00	1142,00
36.512	1450 mm panel width/2880 mm profile length	962,00	1030,00	1100,00	962,00	1235,00	1235,00

**Individual lengths**

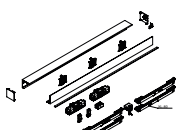

**Note:**  
 For individual lengths from 1781 mm, the price is composed of the basic price for 1780 mm profile length plus surcharge per additional mm (max 5000 mm)!

min. 660, max. 2500 mm Flügelbreite / 5000 mm Profillänge

**max. 80 kg, inkl. DORMOTION XL – 80**

36.520	for installation at wall	Basic price for lengths up to 1780 mm					
		727,00	783,00	836,00	727,00	940,00	940,00
		Surcharge per mm (min. 1781 mm / max. 5000)					
		0,30	0,30	0,30	0,30	0,36	0,36
36.522	for installation at ceiling	Basic price for lengths up to 1780 mm					
		727,00	783,00	836,00	727,00	940,00	940,00
		Surcharge per mm (min. 1781 mm / max. 5000)					
		0,30	0,30	0,30	0,30	0,36	0,36

**Note:**  
 For individual lengths from 2480 mm, the price is composed of the basic price for 2481 mm profile length plus surcharge per additional mm (max 5000 mm)!

**max. 150 kg, incl. DORMOTION XL – 150**

36.521	for installation at wall	Basic 2480 mm / Max. 5000 mm					
		895,00	953,00	1015,00	895,00	1142,00	1142,00
		Surcharge per mm (min. 2481 mm / max. 5000)					
		0,30	0,30	0,30	0,30	0,36	0,36
36.523	for installation at ceiling	Basic 2480 mm / Max. 5000 mm					
		895,00	953,00	1015,00	895,00	1142,00	1142,00
		Surcharge per mm (min. 2481 mm / max. 5000)					
		0,30	0,30	0,30	0,30	0,36	0,36

\* For systems in special color (399) or in white (350), the end caps are supplied in plastic white or anthracite lacquered.

## Complete sets (inclusive DORMOTION, optional with Synchro) for glass door (8–13,5 mm) or timber door (28 - 50 mm), double-leaf, for installation at wall or ceiling

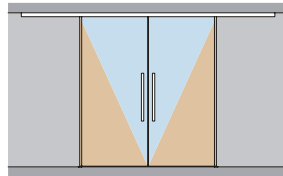
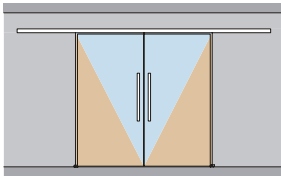

Art. No.	Description	AL anod Silver (150) €/Piece	AL anod sim. Stainl-Steel satin (157) €/Piece	AL p-coat Jet black (304) €/Piece	AL p-coat Traffic white (350) €/Piece	AL anod Special (199) €/Piece	AL p-coat Special color (399) * €/Piece
----------	-------------	------------------------------	-----------------------------------------------	-----------------------------------	---------------------------------------	-------------------------------	-----------------------------------------

For timber door application (including DORMOTION, optionally with Synchro) the adapter profile 36.461 / 36.464 will be necessitated

### MUTO Premium XL 80/150

- 1 track profile max. 5940 mm
- 1 cover profile max. 5940 mm
- 4 clamp carriers (for 8–13.5 mm glass thickness) with anti-jump mechanism
- 4 endstops with safety catch and anti jump device
- 2 floor guides
- 2 end caps
- incl. view protection brushes max. 5940 mm

### Individual lengths

#### Note:

For individual lengths from 3561 mm, the price is composed of the basic price for the profile length plus surcharge per additional mm (max 5940 mm)!

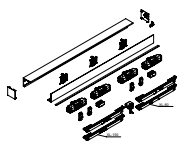

**36.526** For installation at wall max. 80 kg

**36.527** max. 150 kg

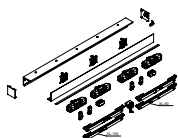

**36.528** For installation at ceiling max. 80 kg

**36.529** max. 150 kg

**36.532** Double-leaf with synchro function with 1 synchro set for installation at wall max. 80 kg

**36.533** max. 150 kg

Basic price for lengths up to 3560 mm						
1456,00	1566,00	1672,00	1456,00	1880,00	1880,00	
Surcharge per mm (min. 3561 mm / max. 5940)						
0,30	0,30	0,30	0,30	0,36	0,36	
Basic price for lengths up to 4960 mm						
1792,00	1903,00	2031,00	1792,00	2283,00	2283,00	
Surcharge per mm (min. 4961 mm / max. 5940)						
0,30	0,30	0,30	0,30	0,36	0,36	
Basic price for lengths up to 3560 mm						
1456,00	1566,00	1672,00	1456,00	1880,00	1880,00	
Surcharge per mm (min. 3561 mm / max. 5940)						
0,30	0,30	0,30	0,30	0,36	0,36	
Basic price for lengths up to 4960 mm						
1792,00	1903,00	2031,00	1792,00	2283,00	2283,00	
Surcharge per mm (min. 4961 mm / max. 5940)						
0,30	0,30	0,30	0,30	0,36	0,36	
Basic price for lengths up to 3560 mm						
1792,00	1903,00		1792,00	2283,00	2283,00	
Surcharge per mm (min. 3561 mm / max. 5940)						
0,30	0,30		0,30	0,36	0,36	
Basic price for lengths up to 3560 mm						
1792,00	1903,00		1792,00	2283,00	2283,00	
Surcharge per mm (min. 3561 mm / max. 5940)						
0,30	0,30		0,30	0,36	0,36	

\* For systems in special color (399) or in white (350), the end caps are supplied in plastic white or anthracite lacquered.

**Glass door (8–13,5 mm) or timber door (28 - 50 mm, single and double-leaf with glass sidelight/s, one and two-sided, installation at ceiling**

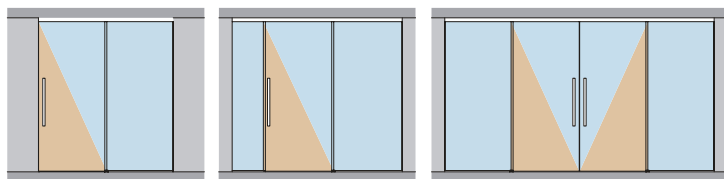

Art. No. Description

AL anod Silver (150)	AL anod sim. Stain- Steel satin (157)	AL p-coat Jet black (304)	AL p-coat Traffic white (350)	AL anod Special (199)	AL p-coat Special color (399) *
€/Piece	€/Piece	€/Piece	€/Piece	€/Piece	€/Piece

Sliding door fittings

**For Timber door application the adapter profile 36.461 / 36.464 will be necessitated**

**MUTO Premium XL 80/150**

- consisting of::  
 1 track profile max. 5000 mm for sidelight connection  
 1 cover profile max. 5000 mm  
 1 sidelight profile max. 5000 mm  
 1 view protection profile depending on panel and sidelight  
 1 filling profile depending on panel and sidelight  
 2 clamp carriers  
 (for 8–13.5 mm glass thickness) with anti-jump mechanism  
 2 endstops with safety catch and anti jump device  
 1 floor guide  
 2 end caps  
 incl. view protection brushes max. 5000 mm  
 1 DORMOTION unit 2021

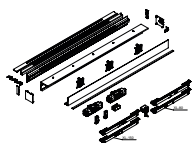

**Individual lengths**

**Note:**  
**For individual lengths from 1781 mm, the price is composed of the basic price for the profile length plus surcharge per additional mm (max 5000 mm)!**

**Set single leaf, with sidelights max. 5000 mm profile length**

**36.515 max. 80 kg, incl. DORMOTION XL – 800**  
 panel width min. 660 mm, max. 2500 mm

Basic price for lengths up to 1780 mm					
845,00	916,00	977,00	845,00	1097,00	1097,00
Surcharge per mm (min. 1781 mm / max. 5000)					
0,35	0,35	0,35	0,35	0,42	0,42

**36.516 max. 150 kg, incl. DORMOTION XL – 150**  
 panel width min. 660 mm, max. 2500 mm

Basic price for lengths up to 2480 mm					
1055,00	1132,00	1206,00	1055,00	1353,00	1353,00
Surcharge per mm (min. 2480 mm / max. 5000)					
0,35	0,35	0,35	0,35	0,42	0,42

**Note:**  
**For individual lengths from 3560 mm, the price is composed of the basic price for the profile length plus surcharge per additional mm (max 5940 mm)!**

**Set double leaf, with sidelights, 2 DORMOTION units 2021 max. 5940 mm profile length**

**36.518 max. 80 kg**  
 panel width: min. 660 mm, max. 1470 mm

Basic price for lengths up to 3560 mm					
1692,00	1830,00	1692,00	1953,00	2192,00	2192,00
Surcharge per mm (min. 3561 mm / max. 5940)					
0,30	0,30	0,30	0,30	0,36	0,36

**36.517 max. 150 kg**  
 panel width: min. 660 mm, max. 1470 mm

Basic price for lengths up to 4560 mm					
2112,00	2262,00	2112,00	2413,00	2706,00	2706,00
Surcharge per mm (min. 4961 mm / max. 5940)					
0,30	0,30	0,30	0,30	0,36	0,36

\* For systems in special color (399) or in white (350), the end caps are supplied in plastic white or anthracite lacquered.

## Glass door (8–13,5 mm) or timber door (28 - 50 mm), single-leaf with glass overpanel and glass sidelights

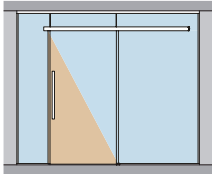

AL anod Silver (150)	AL anod sim. Stain- Steel satin (157)	AL p-coat Jet black (304)	AL p-coat Traffic white (350)	AL anod Special (199)	AL p-coat Special color (399) *
-------------------------------	---------------------------------------------------------	---------------------------------------	-------------------------------------------	--------------------------------	------------------------------------------------

Art. No.	Description	€/Piece	€/Piece	€/Piece	€/Piece	€/Piece
----------	-------------	---------	---------	---------	---------	---------

For Timber door application the adapter profile 36.461 / 36.464 will be necessitated

### Complete sets (inclusive DORMOTION)

#### MUTO Premium XL 80/150

consisting of:  
 1 track profile,  
 1 cover profile,  
 1 counter profile  
 2 clamp carriers  
 (for 8–13.5 mm glass thickness) with anti-jump mechanism  
 2 endstops with safety catch and anti jump device  
 1 floor guide  
 4 end caps  
 incl. view protection brush  
 1 DORMOTION unit 2021

### Defined lengths

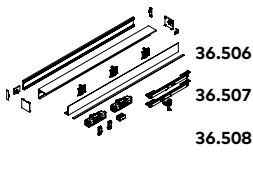

<b>36.506</b>	<b>max. 80 kg, incl. DORMOTION XL – 80</b> 850 mm clear opening / 910 mm panel width/ 1887 mm profile length	873,00	940,00	1005,00	873,00	1129,00	1129,00
<b>36.507</b>	1050 mm clear opening / 1110 mm panel width/ 2287 mm profile length	993,00	1082,00	1155,00	993,00	1297,00	1297,00
<b>36.508</b>	1250 mm clear opening / 1310 mm panel width/ 2687 mm profile length	1095,00	1198,00	1279,00	1095,00	1438,00	1438,00
<b>36.513</b>	<b>max. 150 kg, incl. DORMOTION XL – 150</b> 1250 mm clear opening / 1310 mm panel width/ 2687 mm profile length	1074,00	1142,00	1220,00	1074,00	1371,00	1371,00
<b>36.514</b>	1400 mm clear opening / 1460 mm panel width/ 2987 mm profile length	1155,00	1235,00	1318,00	1155,00	1484,00	1484,00

### Individual lengths

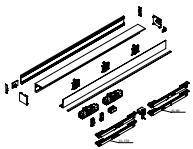

**Note:**  
 For individual lengths from 1887 mm, the price is composed of the basic price for the profile length plus surcharge per additional mm (max 5067 mm)!

<b>36.524</b>	<b>max. 80 kg, incl. DORMOTION XL – 80</b> clear opening min. 600 / max. 2440 mm max. 5067 mm profile length panel width min. 660 / max. 2500 mm max. 5067 mm profile length	Basic price for lengths up to 1887 mm					
		873,00	940,00	1005,00	873,00	1129,00	1129,00
		Surcharge per mm (min. 1888 mm / max. 5067)					
		0,30	0,30	0,30	0,30	0,36	0,36
<b>36.525</b>	<b>max. 150 kg, incl. DORMOTION XL – 150</b> clear opening min. 600 / max. 2440 mm panel width min. 660 / max. 2500 mm	Basic price for lengths up to 2687 mm					
		1074,00	1142,00	1220,00	1074,00	1371,00	1371,00
		Surcharge per mm (min. 2688 mm / max. 5067)					
		0,30	0,30	0,30	0,30	0,36	0,36

Please specify the clear width when you place your order.

\* For systems in special color (399) or in white (350), the end caps are supplied in plastic white or anthracite lacquered.

## Glass door (8–13,5 mm) or timber door (28 - 50 mm), double-leaf with glass overpanel and glass sidelights (optional with Synchro)

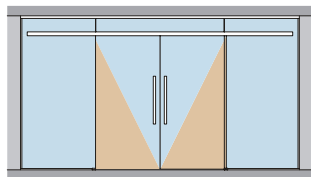

Art. No. Description

AL anod Silver (150)	AL anod sim. Stainl- Steel satin (157)	AL p-coat Jet black (304)	Al p-coat Traffic white (350)	AL anod Special (199)	AL p-coat Special color (399) *
-------------------------------	----------------------------------------------------------	---------------------------------------	-------------------------------------------	--------------------------------	------------------------------------------------

€/Piece	€/Piece	€/Piece	€/Piece	€/Piece	€/Piece
---------	---------	---------	---------	---------	---------

**For Timber door application the adapter profile 36.461 / 36.464 will be necessitated**

**Complete sets**

**MUTO Premium XL 80/150**

**for two panels**

- consisting of:
- 1 track profile max. 5940 mm
- 1 cover profile max. 5940 mm
- 1 counter profile max. 5940 mm
- 4 clamp carriers (for 8–13.5 mm glass thickness) with anti-jump mechanism
- 4 endstops with safety catch and anti jump device
- 2 floor guides
- 4 end caps
- incl. view protection brushes

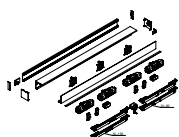

**inclusive 2 DORMOTION units 2021, optional with Synchro**

**Individual lengths**

**Note:**

**For individual lengths from 3775 mm, the price is composed of the basic price for the profile length plus surcharge per additional mm (max 5940 mm)!**

<b>36.530</b>	<b>max. 80 kg</b> panel width min. 660 mm	Basic price for lengths up to 3774 mm					
		<b>1746,00</b>	<b>1880,00</b>	<b>2007,00</b>	<b>1746,00</b>	<b>2257,00</b>	<b>2257,00</b>
		Surcharge per mm (min. 3775 mm / max. 5940)					
		<b>0,30</b>	<b>0,30</b>	<b>0,30</b>	<b>0,30</b>	<b>0,36</b>	<b>0,36</b>
<b>36.531</b>	<b>max. 150 kg</b> panel width min. 660 mm	Basic price for lengths up to 5374 mm					
		<b>2151,00</b>	<b>2283,00</b>	<b>2438,00</b>	<b>2151,00</b>	<b>2742,00</b>	<b>2742,00</b>
		Surcharge per mm (min. 5375 mm / max. 5940)					
		<b>0,30</b>	<b>0,30</b>	<b>0,30</b>	<b>0,30</b>	<b>0,36</b>	<b>0,36</b>

Please specify the clear width when you place your order.

**inclusive Synchro-Set, without DORMOTION**

<b>36.534</b>	<b>max. 80 kg per panel</b> panel width min. 660 mm, max. 1470 mm max. 5940 mm profile length	Basic price for lengths up to 3774 mm					
		<b>2151,00</b>	<b>2283,00</b>	<b>2438,00</b>	<b>2151,00</b>	<b>2742,00</b>	<b>2742,00</b>
		Surcharge per mm (min. 3775 mm / max. 5940)					
		<b>0,30</b>	<b>0,30</b>	<b>0,30</b>	<b>0,30</b>	<b>0,36</b>	<b>0,36</b>

Please specify the clear width when you place your order.

\* For systems in special color (399) or in white (350), the end caps are supplied in plastic white or anthracite lacquered.







## Notes

## Single components MUTO Premium XL 80 / 150

Art. No.	Description	Base parts (000)	AL anod Silver (150)	AL anod sim. Stainl-Steel satin (157)	AL p-coat Jet black (304)	AL p-coat Traffic white (350)	AL anod Special (199)	AL p-coat Special color (399)
		€/Piece	€/Piece	€/Piece	€/Piece	€/Piece	€/Piece	€/Piece
	<b>MUTO Premium XL 80/150 adapter profile for timber panels</b> Profile 12,5 x 36 mm + 12,5 x 4 mm, incl. floor guide for timber panels, incl. accessories 1460 mm	<b>67,00</b>						
36.461		€/m						
36.464	fixed length max. 2500 mm	<b>85,50</b>						
36.550	<b>Accessories set</b> consisting of: 2 clamp carriers with anti-jump mechanism 2 endstops with safety catch 1 floor guide		<b>307,00</b>	<b>307,00</b>	<b>313,00</b>	<b>313,00</b>		
36.552	<b>Track</b> <b>For installation at wall</b> stock length 6000 mm	<b>401,00</b>	<b>468,00</b>	<b>482,00</b>	<b>401,00</b>	<b>561,00</b>	<b>561,00</b>	
		€/m	€/m	€/m	€/m	€/m	€/m	€/m
36.553	fixed length	<b>83,50</b>	<b>96,50</b>	<b>100,00</b>	<b>83,50</b>	<b>117,00</b>	<b>117,00</b>	
36.554	<b>For installation at ceiling</b> stock length 6000 mm	<b>401,00</b>	<b>468,00</b>	<b>482,00</b>	<b>401,00</b>	<b>561,00</b>	<b>561,00</b>	
		€/m	€/m	€/m	€/m	€/m	€/m	€/m
36.555	fixed length	<b>83,50</b>	<b>96,50</b>	<b>100,00</b>	<b>83,50</b>	<b>117,00</b>	<b>117,00</b>	
36.566	<b>Cover profile</b> stock length 6000 mm	<b>156,00</b>	<b>181,00</b>	<b>186,00</b>	<b>156,00</b>	<b>217,00</b>	<b>217,00</b>	
		€/m	€/m	€/m	€/m	€/m	€/m	€/m
36.567	fixed length	<b>33,00</b>	<b>37,00</b>	<b>38,50</b>	<b>33,00</b>	<b>44,50</b>	<b>44,50</b>	
36.556	<b>MUTO Premium XL 80/150 set of end caps</b> for installation at wall and ceiling Plastic, white (350) Plastic, anthracite lacquered (399)		<b>14,00</b>	<b>14,00</b>		<b>14,00</b>		<b>14,00</b>
36.265	<b>MUTO set of view protection brushes for Comfort M, L and Premium XL</b> consisting of: 1 view protection brush 8–10 mm glass thickness 1 view protection brush 12–13.5 mm glass thickness	€/m	<b>12,50</b>					
36.469	<b>Sidelight profile, 69 mm height</b> with gaskets, for 8–13,5 mm glass stock length 6000 mm	<b>196,00</b>	<b>226,00</b>	<b>233,00</b>	<b>196,00</b>	<b>269,00</b>	<b>269,00</b>	
		€/m	€/m	€/m	€/m	€/m	€/m	€/m
36.474	fixed length	<b>41,00</b>	<b>46,50</b>	<b>49,00</b>	<b>41,00</b>	<b>56,00</b>	<b>56,00</b>	
36.800	<b>MUTO view protection profile for Comfort L, Premium XL and Premium Self-Closing,</b> for track profile stock length 6000 mm	<b>83,00</b>	<b>95,50</b>	<b>98,50</b>	<b>83,00</b>	<b>114,00</b>	<b>114,00</b>	
		€/m	€/m	€/m	€/m	€/m	€/m	€/m
36.801	fixed length	<b>17,50</b>	<b>20,00</b>	<b>21,00</b>	<b>17,50</b>	<b>24,00</b>	<b>24,00</b>	
36.802	<b>Filling profile for Comfort L, Premium XL and Premium Self-Closing</b> for track profile stock length 6000 mm	<b>83,00</b>	<b>95,50</b>	<b>98,50</b>	<b>83,00</b>	<b>114,00</b>	<b>114,00</b>	
		€/m	€/m	€/m	€/m	€/m	€/m	€/m
36.803	fixed length	<b>17,50</b>	<b>20,00</b>	<b>21,00</b>	<b>17,50</b>	<b>24,00</b>	<b>24,00</b>	
36.471	<b>Set of end caps</b> for side panel profile, 69 mm height Plastic, white (350) Plastic, anthracite lacquered (399)		<b>14,00</b>	<b>14,00</b>		<b>14,00</b>		<b>14,00</b>
	VSG accessory set, status indicator and integrated lock can be found on page 78-79							

\* For systems in special color (399) or in white (350), the end caps are supplied in plastic white or anthracite lacquered.

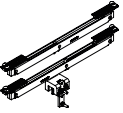
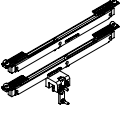
## Single components MUTO Premium XL 80 / 150

Art. No.	Description	Base parts (000)	AL anod Silver (150)	AL anod sim. Stainl-Steel satin (157)	AL p-coat Jet black (304)	AL p-coat Traffic white (350)	AL anod Special (199)	AL p-coat Special color (399)
		€/Piece	€/Piece	€/Piece	€/Piece	€/Piece	€/Piece	€/Piece
	<b>Floor profile</b> incl. 2 end caps <b>for Comfort L, Premium XL and Premium Self-Closing,</b> for side panel fixing, complete with all gaskets, for 8–13,5 mm glass thickness stock length 6000 mm							
	<b>36.810</b>	<b>142,00</b>	<b>163,00</b>	<b>170,00</b>	<b>142,00</b>	<b>197,00</b>	<b>197,00</b>	
		€/m	€/m	€/m	€/m	€/m	€/m	€/m
	<b>36.811</b> fixed length	<b>29,50</b>	<b>34,00</b>	<b>35,50</b>	<b>29,50</b>	<b>41,00</b>	<b>41,00</b>	
	<b>36.812</b> <b>MUTO end caps</b> (2 pcs.) <b>or Comfort L, Premium XL and Premium Self-Closing</b> for floor profile - sidelight fixing Plastic, white (350) Plastic, anthracite lacquered (399)		<b>9,80</b>	<b>9,80</b>		<b>9,80</b>		<b>9,80</b>
	<b>Track profile</b> Installation at glass (incl. gaskets) stock length 6000 mm							
	<b>36.563</b>	<b>401,00</b>	<b>468,00</b>	<b>482,00</b>	<b>401,00</b>	<b>561,00</b>	<b>561,00</b>	
		€/m	€/m	€/m	€/m	€/m	€/m	€/m
	<b>36.564</b> fixed length	<b>83,50</b>	<b>96,50</b>	<b>100,00</b>	<b>83,50</b>	<b>117,00</b>	<b>117,00</b>	
	<b>Counter profile</b> Installation at glass (incl. fixing plates - 2 pieces/m - and gaskets) stock length 6000 mm							
	<b>36.568</b>	<b>192,00</b>	<b>221,00</b>	<b>229,00</b>	<b>192,00</b>	<b>266,00</b>	<b>266,00</b>	
		€/m	€/m	€/m	€/m	€/m	€/m	€/m
	<b>36.569</b> fixed length	<b>41,50</b>	<b>47,00</b>	<b>50,00</b>	<b>41,50</b>	<b>58,00</b>	<b>58,00</b>	
	<b>36.145</b> <b>Fixing plates</b> (installation at glass) (2 Pieces)		<b>8,80</b>					
	<b>36.460</b> <b>Set of end caps</b> for counter profile Plastic, white (350) Plastic, anthracite lacquered (399)		<b>14,00</b>	<b>14,00</b>		<b>14,00</b>		
	<b>DORMOTION unit 2021</b> incl. starter min. panel width 660 mm max. panel width 2500 mm for max. 80 kg							<b>210,00</b>
	<b>36.571</b> for max. 150 kg							<b>266,00</b>
	<b>36.560</b> <b>Synchro-Set</b> for max. 80 kg consisting of: 1 elastic rope, 2 deflexion roller							<b>368,00</b>

VSG accessory set, status indicator and integrated lock can be found on page 78-79

\* For systems in special color (399) or in white (350), the end caps are supplied in plastic white or anthracite lacquered.

## Notes

# MUTO Premium Self-Closing 120



Technical data	
Glass	TSG, LSG (from 2 x TSG)
glass thickness	8-13,5 mm
Max. door weight	120 kg
Applications	single-leaf (glass or timber leaves), glass sidelights, at glass
Material	Aluminium
Finishes	Anodized- and RAL-Colors (coated)
Kind of installation	Wall, ceiling and at glass
Kind of installation	DORMOTION integrated locking mechanism and status indicator are optionally retrofittable Tested acc. DIN EN 1527:2020-04 Height readjustable without dismantling +/-5 mm

Example view for MUTO Premium Self-Closing 120 installation at wall

Sliding door fittings

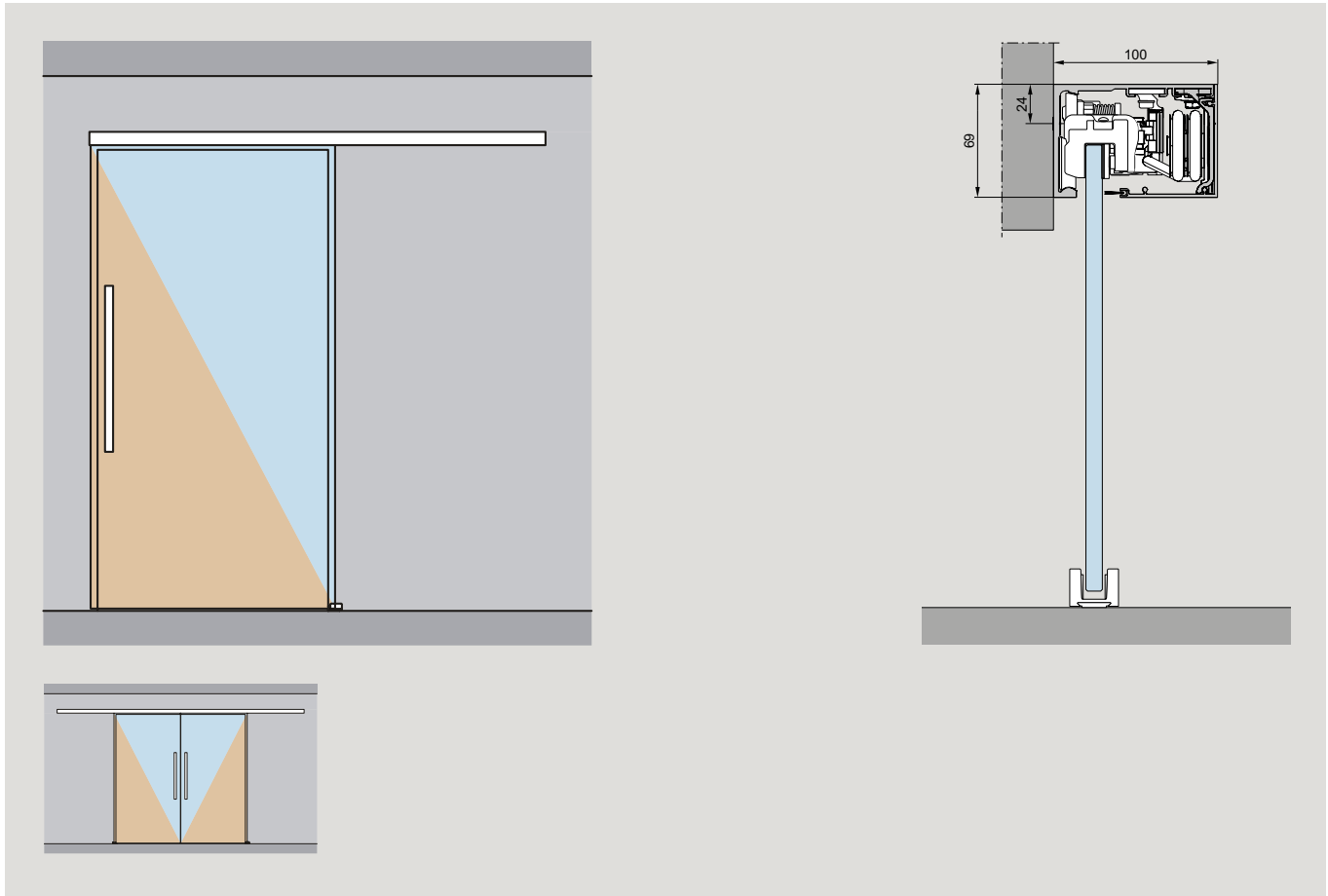

Example view for MUTO Premium Self-Closing 120 Installation at ceiling

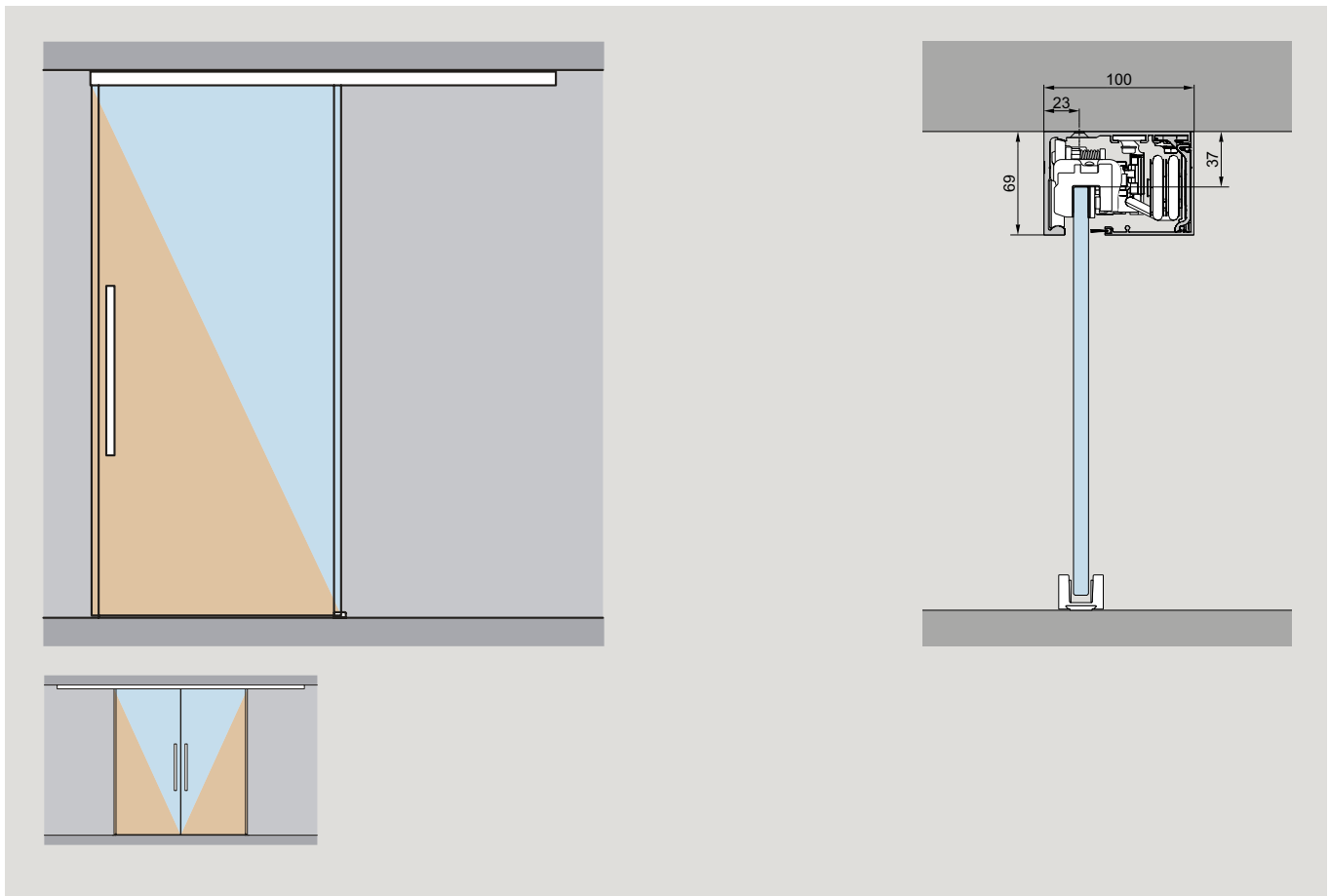

Example view for MUTO Premium Self-Closing 120 with glass sidelight/s

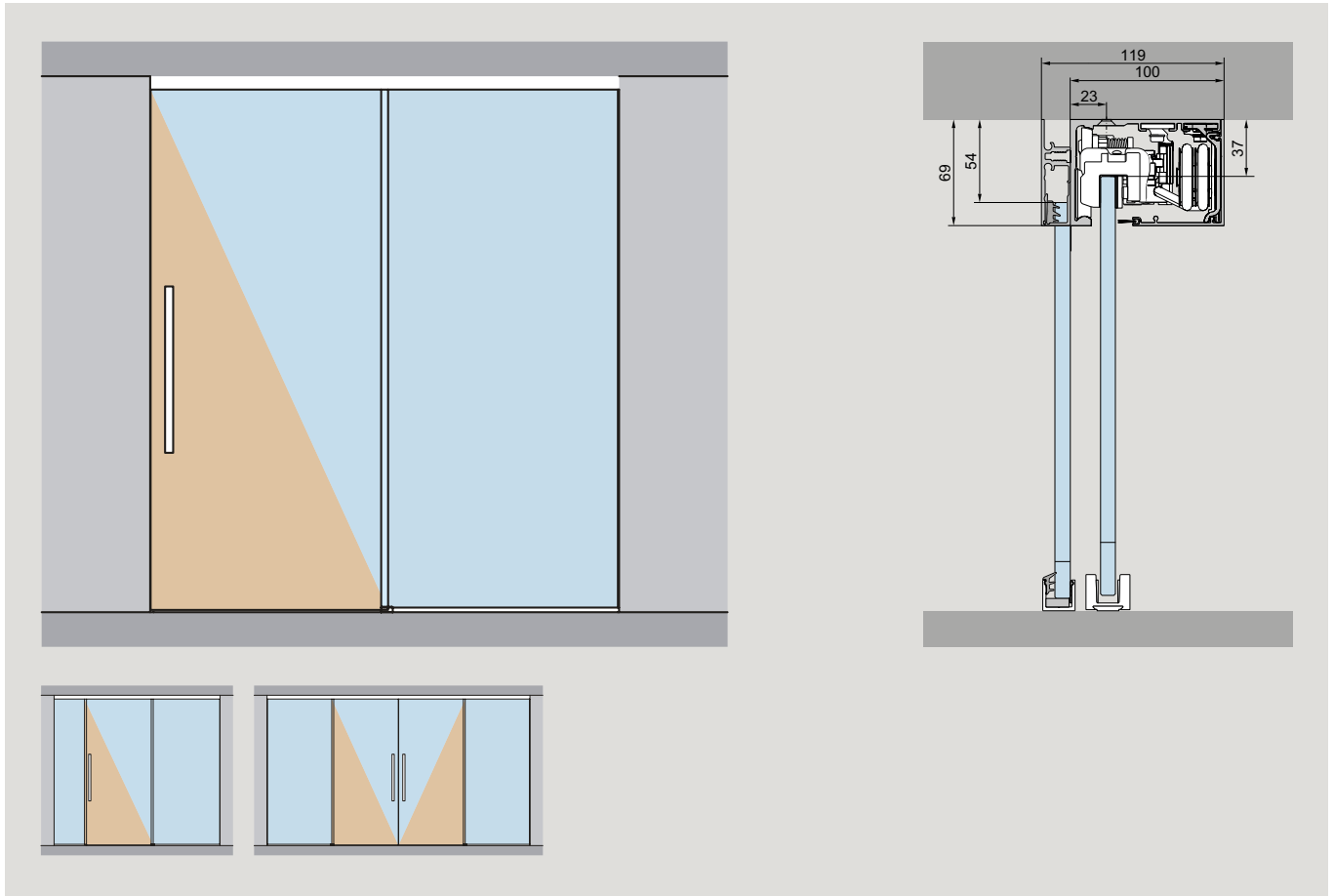

Example view for MUTO Premium Self-Closing 120 with glass overpanel and glass sidelights

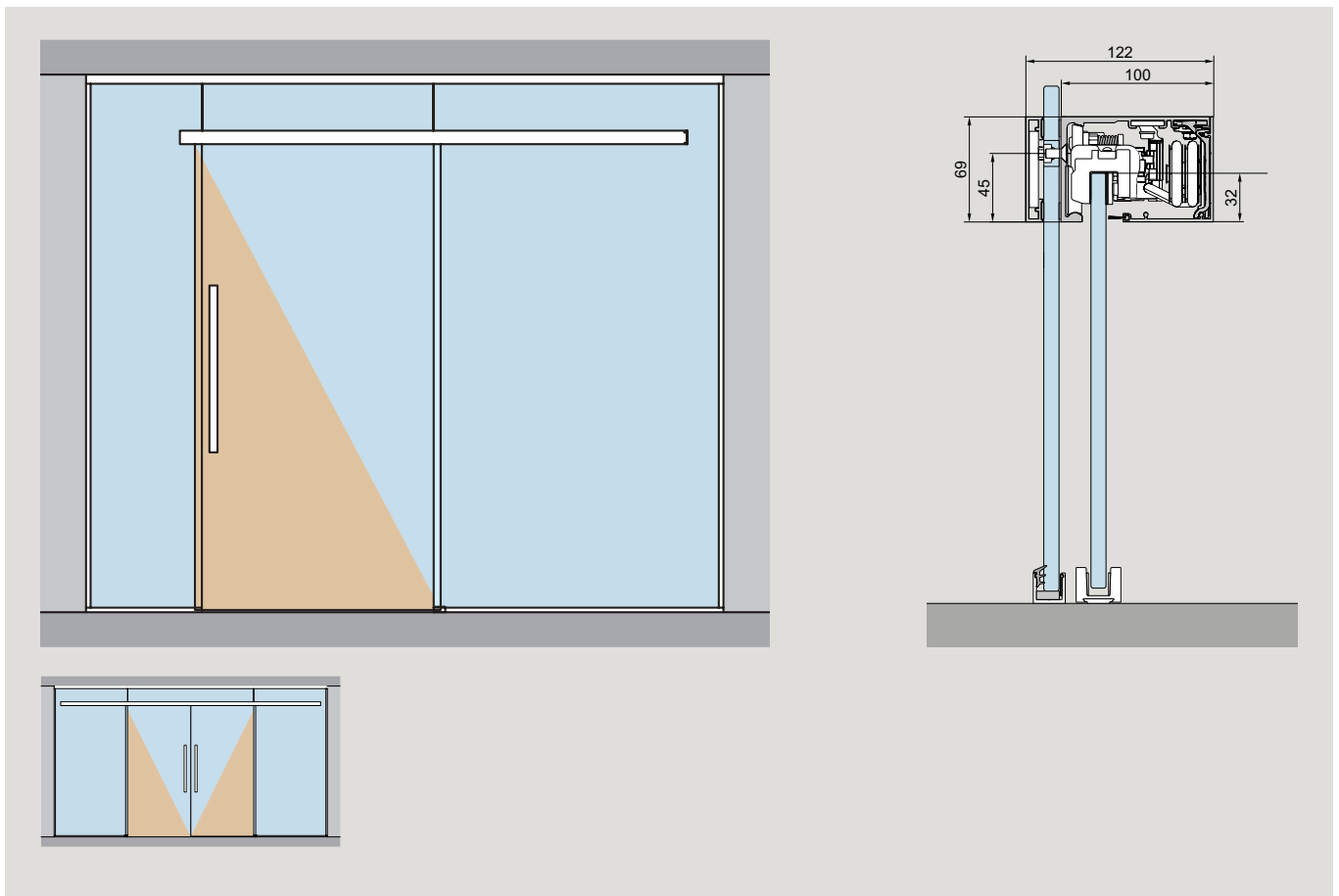

**Complete sets for glass door (8-13,5 mm) or timber door (28 - 50 mm), installation at wall or ceiling**

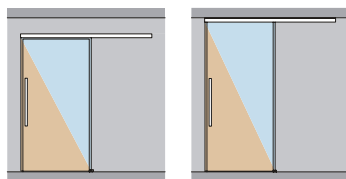

Art. No. Description

AL anod Silver (150)	AL anod sim. Stainl- Steel satin (157)	AI p-coat Traffic white (350)	AL anod Special (199)	AL p-coat Special color (399)  *
€/Piece	€/Piece	€/Piece	€/Piece	€/Piece

For timber door application the adapter profile 36.461 / 36.464 will be necessitated

**MUTO Premium Self-Closing 120**

- consisting of:  
 1 track profile  
 1 cover profile  
 2 clamp carriers  
 (for 8-13.5 mm glass thickness) with anti-jump mechanism  
 2 endstops with safety catch and anti jump device  
 1 floor guide, 2 end caps incl. view protection brushes  
 1 DORMOTION unit 2021 (one-sided)  
 1 elastic rope with accessories

**Defined lengths**

**for 950 mm panel width / 1880 mm profile length**

36.600	Opening direction right, closing direction left (left-hand) <b>for installation at wall</b>	1175,00	1231,00	1175,00	1478,00	1478,00
36.604	<b>for installation at ceiling</b>	1175,00	1231,00	1175,00	1478,00	1478,00

Opening direction left, closing direction right (right-hand)

36.601	<b>for installation at wall</b>	1175,00	1231,00	1175,00	1478,00	1478,00
36.605	<b>for installation at ceiling</b>	1175,00	1231,00	1175,00	1478,00	1478,00

**for 1250 mm panel width / 2480 mm profile length**

36.610	Opening direction right, closing direction left (left-hand) <b>for installation at wall</b>	1275,00	1348,00	1275,00	1592,00	1592,00
36.612	<b>for installation at ceiling</b>	1275,00	1348,00	1275,00	1592,00	1592,00

Opening direction left, closing direction right (right-hand)

36.611	<b>for installation at wall</b>	1275,00	1348,00	1275,00	1592,00	1592,00
36.613	<b>for installation at ceiling</b>	1275,00	1348,00	1275,00	1592,00	1592,00

**for 1450 mm panel width / 2880 mm profile length**

36.602	Opening direction right, closing direction left (left-hand) <b>for installation at wall</b>	1344,00	1427,00	1344,00	1674,00	1674,00
36.606	<b>for installation at ceiling</b>	1344,00	1427,00	1344,00	1674,00	1674,00

Opening direction left, closing direction right (right-hand)

36.603	<b>for installation at wall</b>	1344,00	1427,00	1344,00	1674,00	1674,00
36.607	<b>for installation at ceiling</b>	1344,00	1427,00	1344,00	1674,00	1674,00

\* For systems in special color (399) or in white (350), the end caps are supplied in plastic white or anthracite lacquered.



**Complete sets for glass door (8–13,5 mm) or timber door (28 - 50 mm), installation at wall or ceiling**

				AL anod Silver (150)	AL anod sim. Stain- Steel satin (157)	Al p-coat Traffic white (350)	AL anod Special (199)	AL p-coat Special color (399) *	€/Piece	€/Piece	€/Piece	€/Piece	€/Piece
Art. No.	Description	€/Piece	€/Piece	€/Piece	€/Piece	€/Piece	€/Piece	€/Piece	€/Piece	€/Piece	€/Piece	€/Piece	€/Piece

For Timber door application the adapter profile 36.461 / 36.464 will be necessitated

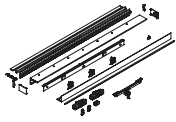

**MUTO Premium Self-Closing 120**

- 1 track profile
- 1 cover profile
- 2 clamp carriers (for 8–13.5 mm glass thickness) with anti-jump mechanism
- 2 endstops with safety catch and anti jump device
- 1 floor guide,
- 2 end caps
- incl. view protection brushes
- 1 DORMOTION unit 2021 (one-sided)
- 1 elastic rope with accessories

**Individual lengths**  
max. 3000 mm profile length

**Note:**  
For individual lengths from 1881 mm, the price is composed of the basic price for the profile length plus surcharge per additional mm (max 3000 mm)!

**for max. 1500 mm panel width**

36.620 Opening direction right, closing direction left (left-hand) **for installation at wall**

Basic price for lengths up to 1880 mm				
1175,00	1231,00	1175,00	1478,00	1478,00
Surcharge per mm (min. 1881 mm / max. 3000)				
0,30	0,30	0,30	0,36	0,36

36.622 **for installation at ceiling**

Basic price for lengths up to 1880 mm				
1175,00	1231,00	1175,00	1478,00	1478,00
Surcharge per mm (min. 1881 mm / max. 3000)				
0,30	0,30	0,30	0,36	0,36

**for max. 1500 mm panel width**

36.621 Opening direction left, closing direction right (right-hand) **for installation at wall**

Basic 3760 mm / Max. 5880 mm				
1175,00	1231,00	1175,00	1478,00	1478,00
Surcharge per mm				
0,30	0,30	0,30	0,36	0,36

36.623 **for installation at ceiling**

Basic 3760 mm / Max. 5880 mm				
1175,00	1231,00	1175,00	1478,00	1478,00
Surcharge per mm				
0,30	0,30	0,30	0,36	0,36

**Individual lengths**  
max. 5880 mm profile length

**Note:**  
For individual lengths from 3761 mm, the price is composed of the basic price for the profile length plus surcharge per additional mm (max 5880 mm)!

**Set for 2-leaf door**

36.626 incl. 2 elastic ropes with accessories **for installation at wall**

Basic 3760 mm / Max. 5880 mm				
2233,00	2339,00	2233,00	2807,00	2807,00
Surcharge per mm				
0,30	0,30	0,30	0,36	0,36

36.627 **for installation at ceiling**

Basic 3760 mm / Max. 5880 mm				
2233,00	2339,00	2233,00	2807,00	2807,00
Surcharge per mm				
0,30	0,30	0,30	0,36	0,36

\* For systems in special color (399) or in white (350), the end caps are supplied in plastic white or anthracite lacquered.

**Glass door (8–13,5 mm) or timber door (28 - 50 mm) with glass sidelight/s, one-sided and two-sided**

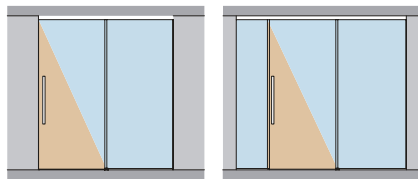

Art. No. Description

AL anod Silver (150)	AL anod sim. Stainl-Steel satin (157)	Al p-coat Traffic white (350)	AL anod Special (199)	AL p-coat Special color (399)
€/Piece	€/Piece	€/Piece	€/Piece	€/Piece

Sliding door fittings

**Complete Sets**

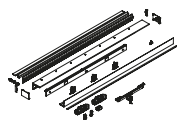

**MUTO Premium Self-Closing 120 for max. 1500 mm panel width**

- consisting of:
- 1 track profile max. 3000 mm for sidelight connection
  - 1 cover profile max. 3000 mm
  - 1 sidelight profile max. 3000 mm
  - 1 view protection profile depending on panel and sidelight
  - 1 filling profile depending on panel and sidelight
  - 2 clamp carriers (for 8–13.5 mm glass thickness) with anti-jump mechanism
  - 2 endstops with safety catch and anti jump device
  - 1 floor guide, 2 end caps
  - incl. view protection brushes max. 3000 mm
  - 1 DORMOTION unit 2021 (one sided)
  - 1 elastic rope with accessories

<b>36.629</b>	Opening direction right, closing direction left (left-hand)	Basic 1880 mm / Max. 3000 mm				
		<b>1298,00</b>	<b>1371,00</b>	<b>1298,00</b>	<b>1641,00</b>	<b>1641,00</b>
		Surcharge per mm				
		<b>0,35</b>	<b>0,35</b>	<b>0,35</b>	<b>0,42</b>	<b>0,42</b>
<b>36.630</b>	Opening direction left, closing direction right (right-hand)	Basic 1880 mm / Max. 3000 mm				
		<b>1298,00</b>	<b>1371,00</b>	<b>1298,00</b>	<b>1641,00</b>	<b>1641,00</b>
		Surcharge per mm				
		<b>0,35</b>	<b>0,35</b>	<b>0,35</b>	<b>0,42</b>	<b>0,42</b>

## Glass door (8–13,5 mm) or timber door (28 - 50 mm) with glass overpanel and glass sidelights

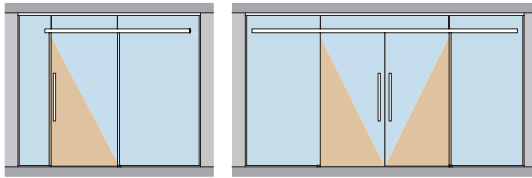

AL anod Silver (150)	AL anod sim. Stainl-Steel satin (157)	Al p-coat Traffic white (350)	AL anod Special (199)	AL p-coat Special color (399)
€/Piece	€/Piece	€/Piece	€/Piece	€/Piece

Art. No.	Description	€/Piece	€/Piece	€/Piece	€/Piece	€/Piece
----------	-------------	---------	---------	---------	---------	---------

For Timber door application the adapter profile 36.461 / 36.464 will be necessitated

### MUTO Premium Self-Closing 120

- consisting of:
- 1 track
  - 1 cover profile
  - 1 counter profile
  - 2 clamp carriers (for 8–13.5 mm glass thickness) with anti-jump mechanism
  - 2 endstops with safety catch and anti jump device
  - 1 floor guide,
  - 4 end caps incl. view protection brushes
  - 1 DORMOTION unit 2021 (one-sided)
  - 1 elastic rope with accessories

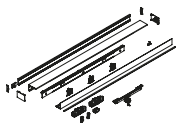

### Defined lengths

Art. No.	Description	1409,00	1477,00	1409,00	1772,00	1772,00
<b>36.614</b>	<b>850 mm clear opening w. / 910 mm panel width / 1887 mm profile length</b> Opening direction right, closing direction left (left-hand)	1409,00	1477,00	1409,00	1772,00	1772,00
<b>36.615</b>	Opening direction left, closing direction right (right-hand)	1409,00	1477,00	1409,00	1772,00	1772,00
<b>36.616</b>	<b>1050 mm clear opening w. / 1110 mm panel width / 2287 mm profile length</b> Opening direction right, closing direction left (left-hand)	1466,00	1544,00	1466,00	1840,00	1840,00
<b>36.617</b>	Opening direction left, closing direction right (right-hand)	1466,00	1544,00	1466,00	1840,00	1840,00
<b>36.608</b>	<b>1250 mm clear opening w./ 1310 mm panel width / 2687 mm profile length</b> Opening direction right, closing direction left (left-hand)	1574,00	1667,00	1574,00	1965,00	1965,00
<b>36.609</b>	Opening direction left, closing direction right (right-hand)	1574,00	1667,00	1574,00	1965,00	1965,00

### Individual lengths

**Note:**  
For individual lengths from 2688 mm, the price is composed of the basic price for the profile length plus surcharge per additional mm (max 3067 mm)!

Art. No.	Description	1574,00	1667,00	1574,00	1965,00	1965,00
<b>36.624</b>	<b>max. 1500 mm panel width / max. 3067 mm profile length</b> Opening direction right, closing direction left (left-hand)	1574,00	1667,00	1574,00	1965,00	1965,00
		0,30	0,30	0,30	0,36	0,36
<b>36.625</b>	Opening direction left, closing direction right (right-hand)	1574,00	1667,00	1574,00	1965,00	1965,00
		0,30	0,30	0,30	0,36	0,36

Please specify the clear width when you place your order.

**Note:**  
For individual lengths from 3761 mm, the price is composed of the basic price for the profile length plus surcharge per additional mm (max 5880 mm)!

### Set for 2-leaf door

Art. No.	Description	2989,00	3167,00	2989,00	3732,00	3732,00
<b>36.628</b>	<b>max. 5880 mm profile length</b> Inclusive 4 clamp carriers (for 8 -13.5 mm glass thickness) with anti jump-mechanism 4 endstops with safety catch 2 floor guides, 2 DORMOTION units 2021 (one-sided) 2 elastic ropes with accessories	2989,00	3167,00	2989,00	3732,00	3732,00
		0,30	0,30	0,30	0,36	0,36

\* For systems in special color (399) or in white (350), the end caps are supplied in plastic white or anthracite lacquered.



## Single components MUTO Premium Self-Closing 120

Art. No.	Description	Base parts (000)	AL anod Silver (150)	AL anod sim. Stain-Steel satin (157)	AL p-coat Jet black (304)	AL p-coat Traffic white (350)	AL anod Special (199)	AL p-coat Special color (399)
Art. No.	Description	€/Piece	€/Piece	€/Piece	€/Piece	€/Piece	€/Piece	€/Piece
	<b>MUTO Premium XL 80/150 adapter profile for timber panels</b> Profile 12,5 x 36 mm + 12,5 x 4 mm, incl. floor guide for timber panels, incl. accessories 1460 mm	67,00						
36.461		€/m						
36.464	Fixed length max. 2500 mm	85,50						
36.550	<b>MUTO Premium XL 80/150 accessories set</b> consisting of: 2 clamp carriers 2 endstops 1 floor guide		307,00	307,00	313,00	313,00		
36.657	<b>MUTO Premium Self-Closing 120 elastic rope</b> with complete accessories Opening to right side	420,00						
36.658	Opening to left side	420,00						
36.648	<b>DORMOTION-Set 2021</b> for max. 120 kg, one-sided, with complete accessories, min. panel width 830 mm, max. panel width 1500 mm Opening direction right, closing direction left (left-hand)	154,00						
36.649	Opening direction left, closing direction right (right-hand)	154,00						
36.666	<b>Optional cushioning unit</b> for opening position for max. 120 kg, one sided on opening position for left and right opening direction with complete accessories	131,00						
	<b>Track</b>							
36.850	<b>For installation at wall</b> stock length 6000 mm	522,00	606,00		522,00	729,00	729,00	
		€/m	€/m		€/m	€/m	€/m	
36.651	fixed length	109,00	126,00		109,00	151,00	151,00	
36.852	<b>For installation at ceiling</b> stock length 6000 mm	522,00	606,00		522,00	729,00	729,00	
		€/m	€/m		€/m	€/m	€/m	
36.653	fixed length	109,00	126,00		109,00	151,00	151,00	
36.854	<b>Cover profile</b> stock length 6000 mm	204,00	234,00		204,00	281,00	281,00	
		€/m	€/m		€/m	€/m	€/m	
36.655	fixed length	42,00	48,00		42,00	59,00	59,00	
36.656	<b>Set of end caps</b> for installation at wall and ceiling	14,00	14,00		14,00			14,00
36.265	<b>Set of view protection brushes for Comfort M, L and Premium XL</b> consisting of: 1 view protection brush 8–10 mm glass thickness 1 view protection brush 12–13.5 mm glass thickness	12,50						
		€/m						

VSG accessory set, status indicator and integrated lock can be found on page 78-79

\* For systems in special color (399) or in white (350), the end caps are supplied in plastic white or anthracite lacquered.

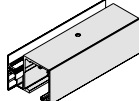
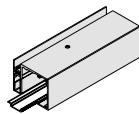
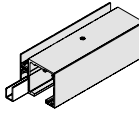
## Single components MUTO Premium Self-Closing 120

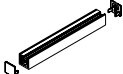
Art. No.	Description	Base parts (000)	AL anod Silver (150)	AL anod sim. Stainl-Steel satin (157)	AL p-coat Jet black (304)	AL p-coat Traffic white (350)	AL anod Special (199)	AL p-coat Special color (399)
		€/Piece	€/Piece	€/Piece	€/Piece	€/Piece	€/Piece	€/Piece
	<b>Side panel profile, 69 mm height,</b> with gaskets, for 8–13,5 mm glass, stock length 6000 mm	<b>196,00</b> €/m	<b>226,00</b> €/m	<b>233,00</b> €/m	<b>196,00</b> €/m	<b>269,00</b> €/m	<b>269,00</b> €/m	
<b>36.469</b>								
<b>36.474</b>	fixed length	<b>41,00</b>	<b>46,50</b>	<b>49,00</b>	<b>41,00</b>	<b>56,00</b>	<b>56,00</b>	
	<b>View protection profile</b> for Comfort L, Premium XL and Premium Self-Closing, for track profile stock length 6000 mm	<b>83,00</b> €/m	<b>95,50</b> €/m	<b>98,50</b> €/m	<b>83,00</b> €/m	<b>114,00</b> €/m	<b>114,00</b> €/m	
<b>36.800</b>								
<b>36.801</b>	fixed length	<b>17,50</b>	<b>20,00</b>	<b>21,00</b>	<b>17,50</b>	<b>24,00</b>	<b>24,00</b>	
	<b>Filling profile</b> for Comfort L, Premium XL and Premium Self-Closing stock length 6000 mm	<b>83,00</b> €/m	<b>95,50</b> €/m	<b>98,50</b> €/m	<b>83,00</b> €/m	<b>114,00</b> €/m	<b>114,00</b> €/m	
<b>36.802</b>								
<b>36.803</b>	fixed length	<b>17,50</b>	<b>20,00</b>	<b>21,00</b>	<b>17,50</b>	<b>24,00</b>	<b>24,00</b>	
	<b>36.471 Set of end caps</b> for side panel profile, 69 mm height	<b>14,00</b>	<b>14,00</b>		<b>14,00</b>		<b>14,00</b>	
	<b>Floor profile</b> incl. 2 end caps for Comfort L, Premium XL and Premium Self-Closing for side panel fixing, complete with all gaskets, for 8–13,5 mm glass thickness stock length 6000 mm	<b>142,00</b> €/m	<b>163,00</b> €/m	<b>170,00</b> €/m	<b>142,00</b> €/m	<b>197,00</b> €/m	<b>197,00</b> €/m	
<b>36.810</b>								
<b>36.811</b>	fixed length	<b>29,50</b>	<b>34,00</b>	<b>35,50</b>	<b>29,50</b>	<b>41,00</b>	<b>41,00</b>	
	<b>36.812 End caps (2 pcs.)</b> for Comfort L, Premium XL and Premium Self-Closing for floor profile - sidelight fixing	<b>9,80</b>	<b>9,80</b>		<b>9,80</b>		<b>9,80</b>	

VSG accessory set, status indicator and integrated lock can be found on page 78-79

\* For systems in special color (399) or in white (350), the end caps are supplied in plastic white or anthracite lacquered.

## Notes

# MUTO Premium Telescopic 80



Technical data	
Glasart	TSG, LSG (from 2 x TSG)
glass thickness	8–13,5 mm
Max. Türflügelgewicht	80 kg (per panel)
Anwendungen	single-leaf, double-leaf, (glass or timber leaves), glass sidelights, at glass
Material	Aluminium
Oberflächen	Anodized- and RAL-Colors (coated)
Montageart	Wall, ceiling and at glass
Ihre Vorteile	DORMOTION (optionally retrofittable) integrated locking mechanism and status indicator are optionally retrofittable Tested acc. DIN EN 1527 Height readjustable without dismantling + 5 mm/–3mm

Example view for MUTO Premium Telescopic 80 installation at wall

Sliding door fittings

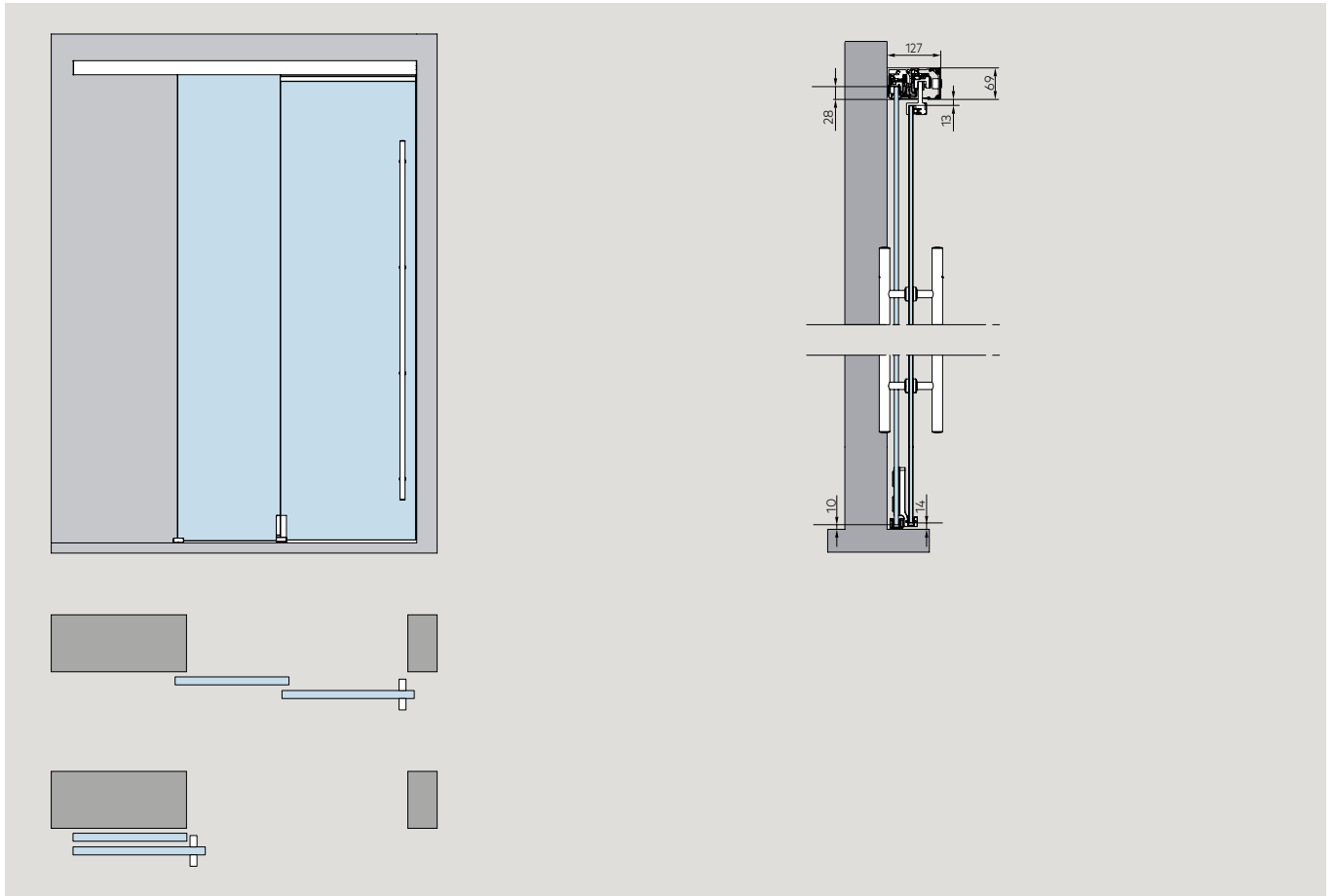

Example view for MUTO Premium Telescopic 80 installation at ceiling

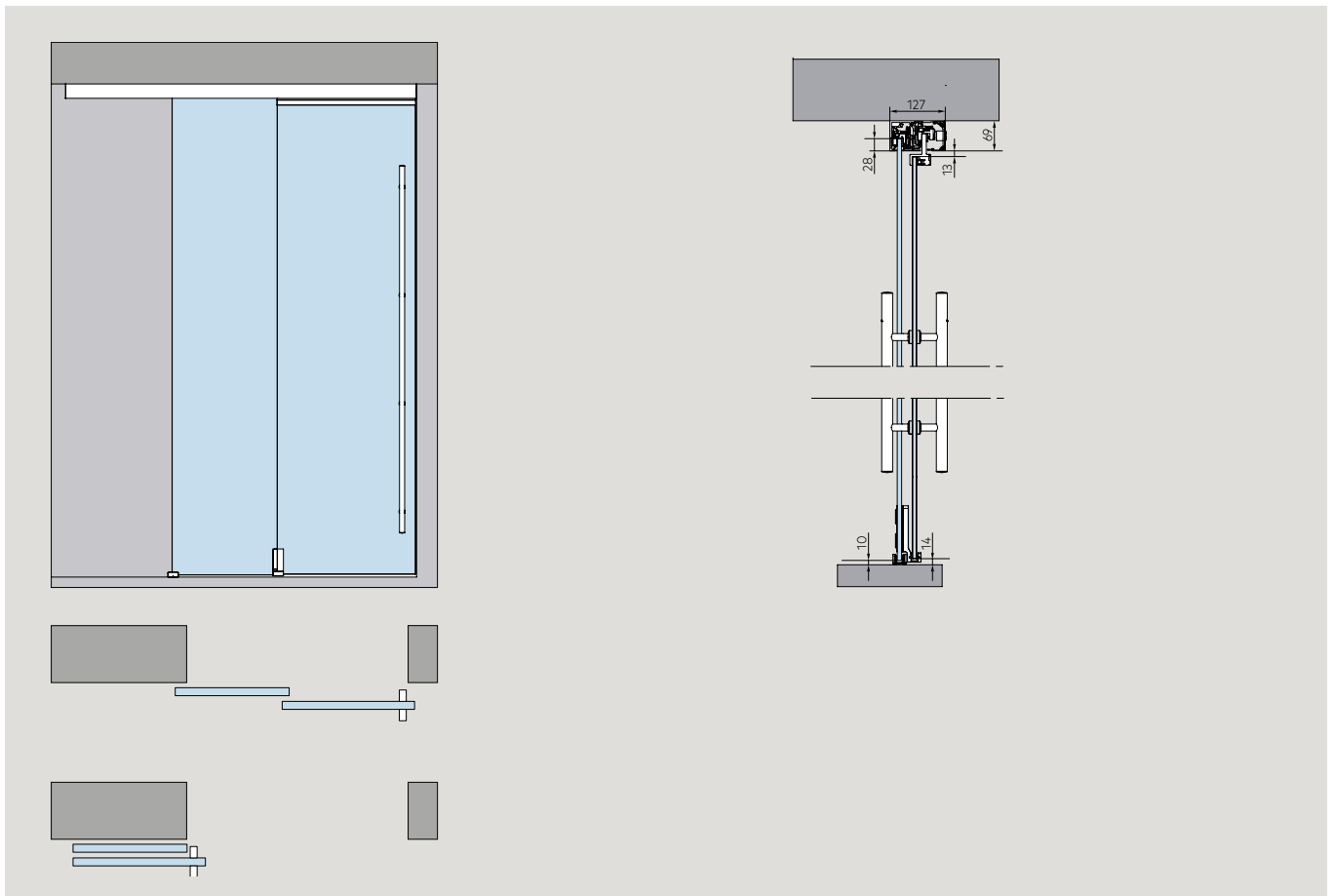



Example view for MUTO Premium Telescopic 80 installation at ceiling with glass sidelight

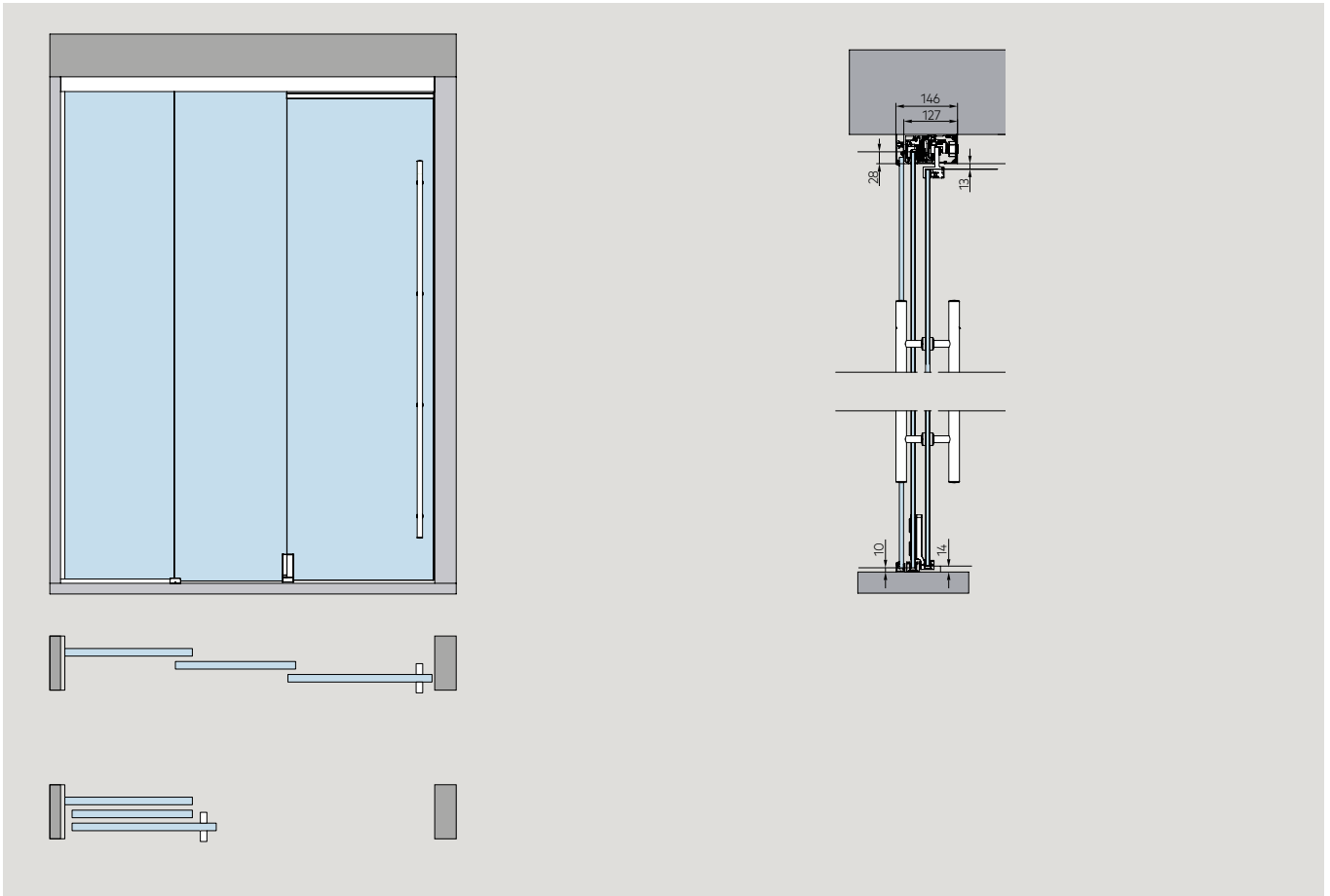

Sliding door fittings

Example view for MUTO Premium Telescopic 80 with glass overpanel and glass sidelight

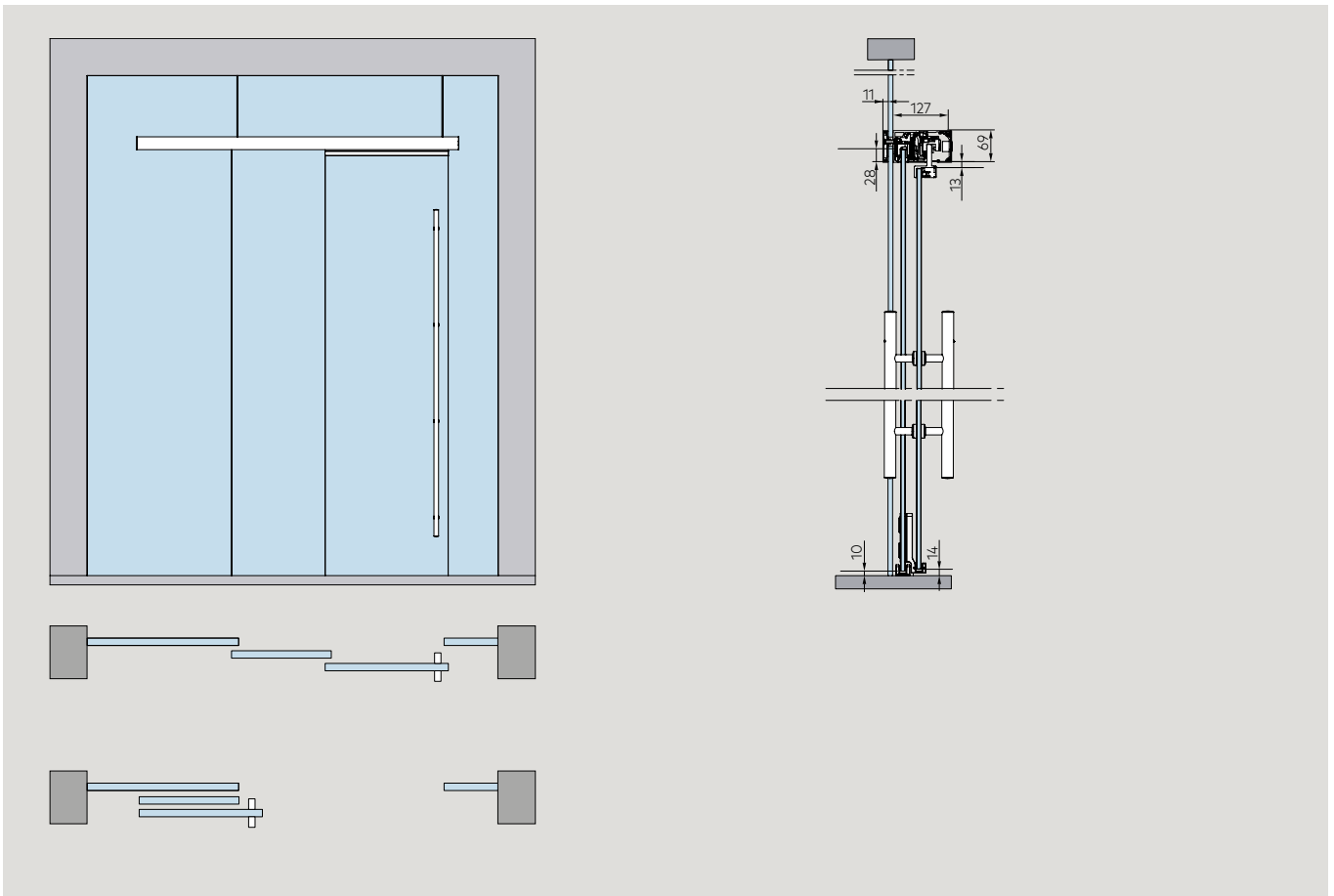

## Glass door (8 - 13,5 mm) for installation at wall, 2 and 4 panels

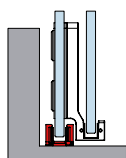

AL anod Silver (150)	AL anod sim. Stain- Steel satin (157)	Al p-coat Traffic white (350)	AL anod Special (199)	AL p-coat Special color (399)  *
-------------------------------	---------------------------------------------------------	-------------------------------------------	--------------------------------	----------------------------------------------------

Art. No.	Description	€/Piece	€/Piece	€/Piece	€/Piece	€/Piece
----------	-------------	---------	---------	---------	---------	---------

**MUTO Premium Telescopic 80**  
Complete sets, prepared for option with DORMOTION

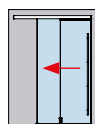

<b>36.701</b>	<b>Set 1</b> Consisting of: 1 profile set Telescopic 4 clamp carriers (for 8–13,5 mm glass thickness) with anti-jump device endstops incl. safety catch 1 Telescopic rope system <b>1 moving floor guide</b> <b>1 floor guide</b> 2 end caps incl. view protection brushes DIN Right Opening direction left, closing direction right	Basic**	<b>1810,00</b>	<b>1920,00</b>	<b>1810,00</b>	<b>2235,00</b>	<b>2235,00</b>
		Surcharge per mm	<b>0,35</b>	<b>0,35</b>	<b>0,35</b>	<b>0,40</b>	<b>0,40</b>

<b>36.737</b>	<b>Set 1.1</b> do., for installation under lintel resp. with wall connection at 90° from closing direction	Basic**	<b>1810,00</b>	<b>1920,00</b>	<b>1810,00</b>	<b>2235,00</b>	<b>2235,00</b>
		Surcharge per mm	<b>0,35</b>	<b>0,35</b>	<b>0,35</b>	<b>0,40</b>	<b>0,40</b>

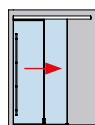

<b>36.702</b>	<b>Set 2</b> Consisting of: 1 profile set Telescopic 4 clamp carriers (for 8–13,5 mm glass thickness) with anti-jump device endstops incl. safety catch 1 Telescopic rope system <b>1 moving floor guide</b> <b>1 floor guide</b> 2 end caps incl. view protection brushes DIN Left Opening direction right, closing direction left	Basic**	<b>1810,00</b>	<b>1920,00</b>	<b>1810,00</b>	<b>2235,00</b>	<b>2235,00</b>
		Surcharge per mm	<b>0,35</b>	<b>0,35</b>	<b>0,35</b>	<b>0,40</b>	<b>0,40</b>

<b>36.738</b>	<b>Set 2.1</b> do., for installation under lintel resp. with wall connection at 90° from closing direction	Basic**	<b>1810,00</b>	<b>1920,00</b>	<b>1810,00</b>	<b>2235,00</b>	<b>2235,00</b>
		Surcharge per mm	<b>0,35</b>	<b>0,35</b>	<b>0,35</b>	<b>0,40</b>	<b>0,40</b>

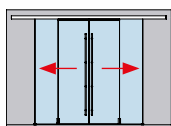

<b>36.709</b>	<b>Set 3</b> Consisting of: 1 profile set Telescopic 8 clamp carriers (for 8–13,5 mm glass thickness) with anti-jump device endstops incl. safety catch 1 Telescopic rope system <b>2 moving floor guides</b> <b>2 floor guides</b> 2 end caps incl. view protection brushes	Basic**	<b>3617,00</b>	<b>3839,00</b>	<b>3617,00</b>	<b>4470,00</b>	<b>4470,00</b>
		Surcharge per mm	<b>0,35</b>	<b>0,35</b>	<b>0,35</b>	<b>0,40</b>	<b>0,40</b>

All MUTO Premium Telescopic 80 units are manufactured to customer specifications. Customisation on site is not possible. Please use our order form, which we will be happy to provide on request (if not available). In the case of an order, you will receive a release drawing.

\* With assemblies in special color (399) the end caps will be delivered in plastic anthracite-grey solid-colored.

\*\* - Basic price valid for track rail length up to 3000 mm, corresponding panel width (slow moving panel) up to 1000 mm. - If the track rail length of 3000 mm is exceeded, the surcharge is calculated per additional mm.

- Example possibilities for track rail length 3000 mm:  
Flush pull grip at fast moving panel - all panels can reach a panel width of 1000 mm.  
Handle bar at fast moving panel (handle bar has to be indented by approx. 120 mm) - panel width of slow moving panel 976,70 mm.

## Glass door (8 - 13,5 mm) for installation at ceiling/with sidelight, 2 and 4 panels

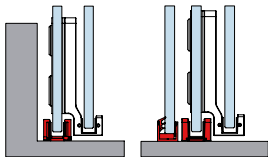

AL anod Silver (150)	AL anod sim. Stain- Steel satin (157)	Al p-coat Traffic white (350)	AL anod Special (199)	AL p-coat Special color (399) *
-------------------------------	---------------------------------------------------------	-------------------------------------------	--------------------------------	------------------------------------------------

Art. No.	Description	€/Piece	€/Piece	€/Piece	€/Piece	€/Piece
----------	-------------	---------	---------	---------	---------	---------

### MUTO Premium Telescopic 80 Complete sets, prepared for option with DORMOTION

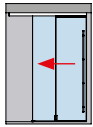

**36.703 Set 4**  
Consisting of:  
1 profile set Telescopic  
4 clamp carriers (for 8–13,5 mm glass thickness)  
with anti-jump device  
endstops incl. safety catch  
1 Telescopic rope system  
**1 moving floor guide**  
**1 floor guide**  
2 end caps incl. view protection brushes  
DIN Right  
Opening direction left, closing direction right

Basic*	1810,00	1920,00	1810,00	2235,00	2235,00
Surcharge per mm	0,35	0,35	0,35	0,40	0,40

**36.739 Set 4.1**  
do., for installation under lintel resp. with  
wall connection at 90° from closing direction

Basic**	1810,00	1920,00	1810,00	2235,00	2235,00
Surcharge per mm	0,35	0,35	0,35	0,40	0,40

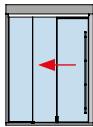

**36.704 Set 5**  
incl. sidelight  
Consisting of:  
1 profile set Telescopic  
4 clamp carriers (for 8–13,5 mm glass thickness)  
with anti-jump device  
endstops incl. safety catch  
1 Telescopic rope system  
**1 moving floor guide**  
**1 floor guide**  
2 end caps incl. view protection brushes  
DIN Right  
Opening direction left, closing direction right

Basic**	2079,00	2222,00	2079,00	2619,00	2619,00
Surcharge per mm	0,35	0,35	0,35	0,40	0,40

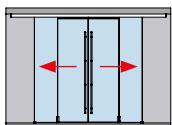

**36.710 Set 6**  
Consisting of:  
1 profile set Telescopic  
8 clamp carriers (for 8–13,5 mm glass thickness)  
with anti-jump device  
endstops incl. safety catch  
1 Telescopic rope system  
**2 moving floor guides**  
**2 floor guides**  
2 end caps incl. view protection brushes

3617,00	3839,00	3617,00	4470,00	4470,00
---------	---------	---------	---------	---------

### Single components (optional)

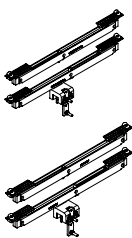

**36.786 MUTO Premium Telescopic 80 DORMOTION unit 2021**  
for panel weights exceeding 80 kg (fast moving plus slow moving panel)

(000)	242,00
-------	--------

**36.361 MUTO Comfort L 80 DORMOTION unit 2021**  
for panel weights up to 80 kg (fast moving plus slow moving panel)

(000)	107,00
-------	--------

All MUTO Premium Telescopic 80 units are manufactured to customer specifications. Customisation on site is not possible.  
Please use our order form, which we will be happy to provide on request (if not available).  
In the case of an order, you will receive a release drawing.

\* With assemblies in special color (399) the end caps will be delivered in plastic anthracite-grey solid-colored.

\*\* - Basic price valid for track rail length up to 3000 mm, corresponding panel width (slow moving panel) up to 1000 mm.  
- If the track rail length of 3000 mm is exceeded, the surcharge is calculated per additional mm.

- Example possibilities for track rail length 3000 mm:  
Flush pull grip at fast moving panel - all panels can reach a panel width of 1000 mm.  
Handle bar at fast moving panel (handle bar has to be indented by approx. 120 mm) - panel width of slow moving panel 976,70 mm.

LSG accessories, Status-indicator and integrated locking mechanism on pages 144–145.

**Glass door (8 - 13,5 mm) for installation at ceiling/with sidelight, 2 and 4 panels**

Sliding door fittings

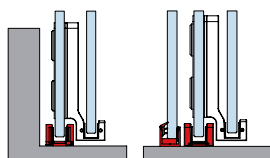

AL anod Silver (150)	AL anod sim. Stain- Steel satin (157)	Al p-coat Traffic white (350)	AL anod Special (199)	AL p-coat Special color (399) *
-------------------------------	---------------------------------------------------------	-------------------------------------------	--------------------------------	------------------------------------------------

Art. No.	Description	€/Piece	€/Piece	€/Piece	€/Piece	€/Piece
----------	-------------	---------	---------	---------	---------	---------

**MUTO Premium Telescopic 80  
Complete sets, prepared for option with DORMOTION**

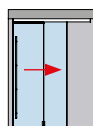

**36.705 Set 7**  
Consisting of:  
1 profile set Telescopic  
4 clamp carriers (for 8–13,5 mm glass thickness)  
with anti-jump device  
endstops incl. safety catch  
1 Telescopic rope system  
**1 moving floor guide**  
**1 floor guide**  
2 end caps incl. view protection brushes  
DIN Left  
Opening direction right, closing direction left

Basic**	<b>1810,00</b>	<b>1920,00</b>	<b>1810,00</b>	<b>2235,00</b>	<b>2235,00</b>
Surcharge per mm	<b>0,35</b>	<b>0,35</b>	<b>0,35</b>	<b>0,40</b>	<b>0,40</b>

**36.740 Set 7.1**  
do., for installation under lintel resp. with  
wall connection at 90° from closing direction

Basic**	<b>1810,00</b>	<b>1920,00</b>	<b>1810,00</b>	<b>2235,00</b>	<b>2235,00</b>
Surcharge per mm	<b>0,35</b>	<b>0,35</b>	<b>0,35</b>	<b>0,40</b>	<b>0,40</b>

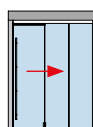

**36.706 Set 8**  
incl. sidelight  
Consisting of:  
1 profile set Telescopic  
4 clamp carriers (for 8–13,5 mm glass thickness)  
with anti-jump device  
endstops incl. safety catch  
1 Telescopic rope system  
**1 moving floor guide**  
**1 floor guide**  
2 end caps incl. view protection brushes  
DIN Left  
Opening direction right, closing direction left

Basic**	<b>2079,00</b>	<b>2222,00</b>	<b>2079,00</b>	<b>2619,00</b>	<b>2619,00</b>
Surcharge per mm	<b>0,35</b>	<b>0,35</b>	<b>0,35</b>	<b>0,40</b>	<b>0,40</b>

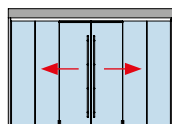

**36.711 Set 9**  
incl. sidelight  
Consisting of:  
1 profile set Telescopic  
8 clamp carriers (for 8–13,5 mm glass thickness)  
with anti-jump device  
endstops incl. safety catch  
1 Telescopic rope system  
**2 moving floor guides**  
**2 floor guides**  
2 end caps incl. view protection brushes

<b>4158,00</b>	<b>4444,00</b>	<b>4158,00</b>	<b>5236,00</b>	<b>5236,00</b>
----------------	----------------	----------------	----------------	----------------

All MUTO Premium Telescopic 80 units are manufactured to customer specifications. Customisation on site is not possible. Please use our order form, which we will be happy to provide on request (if not available). In the case of an order, you will receive a release drawing.

\* With assemblies in special color (399) the end caps will be delivered in plastic anthracite-grey solid-colored.

\*\* - Basic price valid for track rail length up to 3000 mm, corresponding panel width (slow moving panel) up to 1000 mm. - If the track rail length of 3000 mm is exceeded, the surcharge is calculated per additional mm.

- Example possibilities for track rail length 3000 mm:  
Flush pull grip at fast moving panel - all panels can reach a panel width of 1000 mm.  
Handle bar at fast moving panel (handle bar has to be indented by approx. 120 mm) - panel width of slow moving panel 976,70 mm.

## Glass door (8 - 13,5 mm) with glass overpanel and glass sidelights, 2 and 4 panels

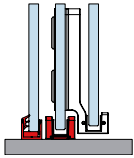

AL anod Silver (150)	AL anod sim. Stain- Steel satin (157)	Al p-coat Traffic white (350)	AL anod Special (199)	AL p-coat Special color (399) *
-------------------------------	---------------------------------------------------------	-------------------------------------------	--------------------------------	------------------------------------------------

Art. No.	Description	€/Piece	€/Piece	€/Piece	€/Piece	€/Piece
----------	-------------	---------	---------	---------	---------	---------

### MUTO Premium Telescopic 80 Complete sets, prepared for option with DORMOTION

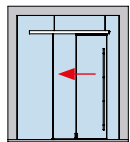

**36.707 Set 10**  
incl. sidelight  
Consisting of:  
1 profile set Telescopic  
4 clamp carriers (for 8–13,5 mm glass thickness)  
with anti-jump device  
endstops incl. safety catch  
1 Telescopic rope system  
**1 moving floor guide**  
**1 floor guide**  
2 end caps incl. view protection brushes  
DIN Right  
Opening direction left, closing direction right

Basic**	2098,00	2235,00	2098,00	2609,00	2609,00
Surcharge per mm	0,35	0,35	0,35	0,40	0,40

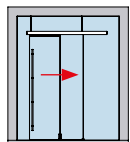

**36.708 Set 11**  
incl. sidelight  
Consisting of:  
1 profile set Telescopic  
4 clamp carriers (for 8–13,5 mm glass thickness)  
with anti-jump device  
endstops incl. safety catch  
1 Telescopic rope system  
**1 moving floor guide**  
**1 floor guide**  
2 end caps incl. view protection brushes  
DIN Left  
Opening direction right, closing direction left

Basic**	2098,00	2235,00	2098,00	2609,00	2609,00
Surcharge per mm	0,35	0,35	0,35	0,40	0,40

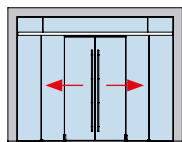

**36.712 Set 12**  
incl. sidelight  
Consisting of:  
1 profile set Telescopic  
8 clamp carriers (for 8–13,5 mm glass thickness)  
with anti-jump device  
endstops incl. safety catch  
1 Telescopic rope system  
**2 moving floor guides**  
**2 floor guides**  
2 end caps incl. view protection brushes

4184,00	4470,00	4184,00	5221,00	5221,00
---------	---------	---------	---------	---------

### Single components (optional)

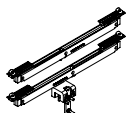

**36.786 MUTO Premium Telescopic 80 DORMOTION unit 2021**  
for panel weights exceeding 80 kg (fast moving plus slow moving panel)

(000)	242,00
-------	--------

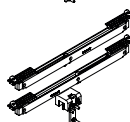

**36.361 MUTO Comfort L 80 DORMOTION unit 2021**  
for panel weights up to 80 kg (fast moving plus slow moving panel)

(000)	107,00
-------	--------

All MUTO Premium Telescopic 80 units are manufactured to customer specifications. Customisation on site is not possible. Please use our order form, which we will be happy to provide on request (if not available). In the case of an order, you will receive a release drawing.

\* With assemblies in special color (399) the end caps will be delivered in plastic anthracite-grey solid-colored.

\*\* - Basic price valid for track rail length up to 3000 mm, corresponding panel width (slow moving panel) up to 1000 mm. - If the track rail length of 3000 mm is exceeded, the surcharge is calculated per additional mm.

- Example possibilities for track rail length 3000 mm:  
Flush pull grip at fast moving panel - all panels can reach a panel width of 1000 mm.  
Handle bar at fast moving panel (handle bar has to be indented by approx. 120 mm) - panel width of slow moving panel 976,70 mm.

LSG accessories, Status-indicator and integrated locking mechanism on pages 144–145.

## Glass door (8 - 13,5 mm) for installation at wall, 2 and 4 panels

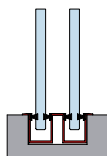

AL anod Silver (150)	AL anod sim. Stain- Steel satin (157)	Al p-coat Traffic white (350)	AL anod Special (199)	AL p-coat Special color (399) *
-------------------------------	---------------------------------------------------------	-------------------------------------------	--------------------------------	------------------------------------------------

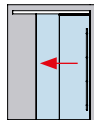
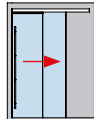
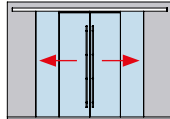
Art. No.	Description	€/Piece	€/Piece	€/Piece	€/Piece	€/Piece	
<b>MUTO Premium Telescopic 80</b>							
<b>Complete sets, prepared for option with DORMOTION</b>							
	<b>36.713 Set 13</b> Consisting of: 1 profile set Telescopic 4 clamp carriers (for 8–13,5 mm glass thickness) with anti-jump device endstops incl. safety catch 1 Telescopic rope system <b>recessed floor guide set</b> 2 end caps incl. view protection brushes DIN Right Opening direction left, closing direction right	Basic**	<b>1810,00</b>	<b>1920,00</b>	<b>1810,00</b>	<b>2235,00</b>	<b>2235,00</b>
		Surcharge per mm	<b>0,35</b>	<b>0,35</b>	<b>0,35</b>	<b>0,40</b>	<b>0,40</b>
	<b>36.714 Set 14</b> Consisting of: 1 profile set Telescopic 4 clamp carriers (for 8–13,5 mm glass thickness) with anti-jump device endstops incl. safety catch 1 Telescopic rope system <b>recessed floor guide set</b> 2 end caps incl. view protection brushes DIN Left Opening direction right, closing direction left	Basic**	<b>1810,00</b>	<b>1920,00</b>	<b>1810,00</b>	<b>2235,00</b>	<b>2235,00</b>
		Surcharge per mm	<b>0,35</b>	<b>0,35</b>	<b>0,35</b>	<b>0,40</b>	<b>0,40</b>
	<b>36.721 Set 15</b> Consisting of: 1 profile set Telescopic 8 clamp carriers (for 8–13,5 mm glass thickness) with anti-jump device endstops incl. safety catch 1 Telescopic rope system <b>recessed floor guide set</b> 2 end caps incl. view protection brushes	Basic**	<b>3617,00</b>	<b>3839,00</b>	<b>3617,00</b>	<b>4470,00</b>	<b>4470,00</b>
		Surcharge per mm	<b>0,35</b>	<b>0,35</b>	<b>0,35</b>	<b>0,40</b>	<b>0,40</b>

All MUTO Premium Telescopic 80 units are manufactured to customer specifications. Customisation on site is not possible. Please use our order form, which we will be happy to provide on request (if not available). In the case of an order, you will receive a release drawing.

\* With assemblies in special color (399) the end caps will be delivered in plastic anthracite-grey solid-colored.

\*\* - Basic price valid for track rail length up to 3000 mm, corresponding panel width (slow moving panel) up to 1000 mm. - If the track rail length of 3000 mm is exceeded, the surcharge is calculated per additional mm.

- Example possibilities for track rail length 3000 mm:  
Flush pull grip at fast moving panel - all panels can reach a panel width of 1000 mm.  
Handle bar at fast moving panel (handle bar has to be indented by approx. 120 mm) - panel width of slow moving panel 976,70 mm.

## Glass door (8 - 13,5 mm) for installation at ceiling/with sidelight, 2 and 4 panels

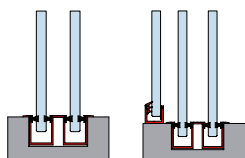

AL anod Silver (150)	AL anod sim. Stain- Steel satin (157)	Al p-coat Traffic white (350)	AL anod Special (199)	AL p-coat Special color (399) *
-------------------------------	---------------------------------------------------------	-------------------------------------------	--------------------------------	------------------------------------------------

Art. No.	Description	€/Piece	€/Piece	€/Piece	€/Piece	€/Piece
----------	-------------	---------	---------	---------	---------	---------

### MUTO Premium Telescopic 80 Complete sets, prepared for option with DORMOTION

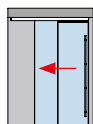

**36.715 Set 16**  
Consisting of:  
1 profile set Telescopic  
4 clamp carriers (for 8–13,5 mm glass thickness)  
with anti-jump device  
endstops incl. safety catch  
1 Telescopic rope system  
**recessed floor guide set**  
2 end caps incl. view protection brushes  
DIN Right  
Opening direction left, closing direction right

Basic**	1810,00	1920,00	1810,00	2235,00	2235,00
Surcharge per mm	0,35	0,35	0,35	0,40	0,40

**36.743 Set 16.1**  
do., for installation under lintel resp. with  
wall connection at 90° from closing direction

Basic**	1810,00	1920,00	1810,00	2235,00	2235,00
Surcharge per mm	0,35	0,35	0,35	0,40	0,40

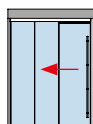

**36.716 Set 17**  
incl. sidelight  
Consisting of:  
1 profile set Telescopic  
4 clamp carriers (for 8–13,5 mm glass thickness)  
with anti-jump device  
endstops incl. safety catch  
1 Telescopic rope system  
**recessed floor guide set**  
2 end caps incl. view protection brushes  
DIN Right  
Opening direction left, closing direction right

Basic**	2079,00	2222,00	2079,00	2619,00	2619,00
Surcharge per mm	0,35	0,35	0,35	0,40	0,40

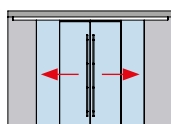

**36.722 Set 18**  
Consisting of:  
1 profile set Telescopic  
8 clamp carriers (for 8–13,5 mm glass thickness)  
with anti-jump device  
endstops incl. safety catch  
1 Telescopic rope system  
**recessed floor guide set**  
2 end caps incl. view protection brushes

3617,00	3839,00	3617,00	4470,00	4470,00
---------	---------	---------	---------	---------

### Single components (optional)

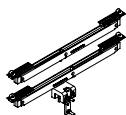

**36.786 MUTO Premium Telescopic 80 DORMOTION unit 2021**  
for panel weights exceeding 80 kg (fast moving plus slow moving panel)

(000)  
242,00

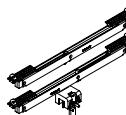

**36.361 MUTO Comfort L 80 DORMOTION unit 2021**  
for panel weights up to 80 kg (fast moving plus slow moving panel)

(000)  
107,00

All MUTO Premium Telescopic 80 units are manufactured to customer specifications. Customisation on site is not possible. Please use our order form, which we will be happy to provide on request (if not available). In the case of an order, you will receive a release drawing.

\* With assemblies in special color (399) the end caps will be delivered in plastic anthracite-grey solid-colored.

\*\* - Basic price valid for track rail length up to 3000 mm, corresponding panel width (slow moving panel) up to 1000 mm. - If the track rail length of 3000 mm is exceeded, the surcharge is calculated per additional mm.

- Example possibilities for track rail length 3000 mm:  
Flush pull grip at fast moving panel - all panels can reach a panel width of 1000 mm.  
Handle bar at fast moving panel (handle bar has to be indented by approx. 120 mm) - panel width of slow moving panel 976,70 mm.

LSG accessories, Status-indicator and integrated locking mechanism on pages 144–145.

**Glass door (8 - 13,5 mm) for installation at ceiling/with sidelight, 2 and 4 panels**

Sliding door fittings

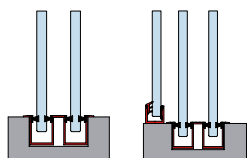

AL anod Silver (150)	AL anod sim. Stain- Steel satin (157)	Al p-coat Traffic white (350)	AL anod Special (199)	AL p-coat Special color (399) *
-------------------------------	---------------------------------------------------------	-------------------------------------------	--------------------------------	------------------------------------------------

Art. No.	Description	€/Piece	€/Piece	€/Piece	€/Piece	€/Piece
----------	-------------	---------	---------	---------	---------	---------

**MUTO Premium Telescopic 80  
Complete sets, prepared for option with DORMOTION**

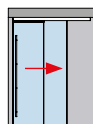

**36.717 Set 19**  
Consisting of:  
1 profile set Telescopic  
4 clamp carriers (for 8–13,5 mm glass thickness)  
with anti-jump device  
endstops incl. safety catch  
1 Telescopic rope system  
**recessed floor guide set**  
2 end caps incl. view protection brushes  
DIN Left  
Opening direction right, closing direction left

Basic**	<b>1810,00</b>	<b>1920,00</b>	<b>1810,00</b>	<b>2235,00</b>	<b>2235,00</b>
Surcharge per mm	<b>0,35</b>	<b>0,35</b>	<b>0,35</b>	<b>0,40</b>	<b>0,40</b>

**36.744 Set 19.1**  
do., for installation under lintel resp. with  
wall connection at 90° from closing direction

Basic**	<b>1810,00</b>	<b>1920,00</b>	<b>1810,00</b>	<b>2235,00</b>	<b>2235,00</b>
Surcharge per mm	<b>0,35</b>	<b>0,35</b>	<b>0,35</b>	<b>0,40</b>	<b>0,40</b>

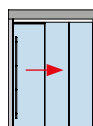

**36.718 Set 20**  
incl. sidelight  
Consisting of:  
1 profile set Telescopic  
4 clamp carriers (for 8–13,5 mm glass thickness)  
with anti-jump device  
endstops incl. safety catch  
1 Telescopic rope system  
**recessed floor guide set**  
2 end caps incl. view protection brushes  
DIN Left  
Opening direction right, closing direction left

Basic**	<b>2079,00</b>	<b>2222,00</b>	<b>2079,00</b>	<b>2619,00</b>	<b>2619,00</b>
Surcharge per mm	<b>0,35</b>	<b>0,35</b>	<b>0,35</b>	<b>0,40</b>	<b>0,40</b>

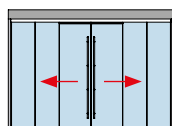

**36.723 Set 21**  
incl. sidelight  
Consisting of:  
1 profile set Telescopic  
8 clamp carriers (for 8–13,5 mm glass thickness)  
with anti-jump device  
endstops incl. safety catch  
1 Telescopic rope system  
**recessed floor guide set**  
2 end caps incl. view protection brushes

<b>4158,00</b>	<b>4444,00</b>	<b>4158,00</b>	<b>5236,00</b>	<b>5236,00</b>
----------------	----------------	----------------	----------------	----------------

All MUTO Premium Telescopic 80 units are manufactured to customer specifications. Customisation on site is not possible. Please use our order form, which we will be happy to provide on request (if not available). In the case of an order, you will receive a release drawing.

\* With assemblies in special color (399) the end caps will be delivered in plastic anthracite-grey solid-colored.

\*\* - Basic price valid for track rail length up to 3000 mm, corresponding panel width (slow moving panel) up to 1000 mm. - If the track rail length of 3000 mm is exceeded, the surcharge is calculated per additional mm.

- Example possibilities for track rail length 3000 mm:  
Flush pull grip at fast moving panel - all panels can reach a panel width of 1000 mm.  
Handle bar at fast moving panel (handle bar has to be indented by approx. 120 mm) - panel width of slow moving panel 976,70 mm.



## Glass door (8 - 13,5 mm) with glass overpanel and glass sidelights, 2 and 4 panels

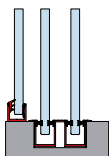

AL anod Silver (150)	AL anod sim. Stain- Steel satin (157)	Al p-coat Traffic white (350)	AL anod Special (199)	AL p-coat Special color (399) *
-------------------------------	---------------------------------------------------------	-------------------------------------------	--------------------------------	------------------------------------------------

Art. No.	Description	€/Piece	€/Piece	€/Piece	€/Piece	€/Piece
----------	-------------	---------	---------	---------	---------	---------

### MUTO Premium Telescopic 80 Complete sets, prepared for option with DORMOTION

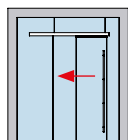

**36.719 Set 22**  
incl. sidelight  
Consisting of:  
1 profile set Telescopic  
4 clamp carriers (for 8–13,5 mm glass thickness)  
with anti-jump device  
endstops incl. safety catch  
1 Telescopic rope system  
**recessed floor guide set**  
2 end caps incl. view protection brushes  
DIN Right  
Opening direction left, closing direction right

Basic**	2098,00	2235,00	2098,00	2609,00	2609,00
Surcharge per mm	0,35	0,35	0,35	0,40	0,40

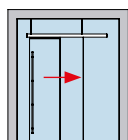

**36.720 Set 23**  
incl. sidelight  
Consisting of:  
1 profile set Telescopic  
4 clamp carriers (for 8–13,5 mm glass thickness)  
with anti-jump device  
endstops incl. safety catch  
1 Telescopic rope system  
**recessed floor guide set**  
2 end caps  
incl. view protection brushes  
DIN Left  
Opening direction right, closing direction left

Basic**	2098,00	2235,00	2098,00	2609,00	2609,00
Surcharge per mm	0,35	0,35	0,35	0,40	0,40

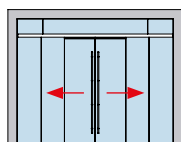

**36.724 Set 24**  
incl. sidelight  
Consisting of:  
1 profile set Telescopic  
8 clamp carriers (for 8–13,5 mm glass thickness)  
with anti-jump device  
endstops incl. safety catch  
1 Telescopic rope system  
**recessed floor guide set**  
2 end caps incl. view protection brushes

4197,00	4470,00	4197,00	5221,00	5221,00
---------	---------	---------	---------	---------

### Single components (optional)

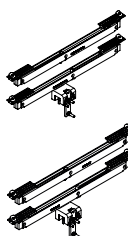

**36.786 MUTO Premium Telescopic 80 DORMOTION unit 2021**  
for panel weights exceeding 80 kg (fast moving plus slow moving panel)

(000)	242,00
-------	--------

**36.361 MUTO Comfort L 80 DORMOTION unit 2021**  
for panel weights up to 80 kg (fast moving plus slow moving panel)

(000)	107,00
-------	--------

All MUTO Premium Telescopic 80 units are manufactured to customer specifications. Customisation on site is not possible. Please use our order form, which we will be happy to provide on request (if not available). In the case of an order, you will receive a release drawing.

\* With assemblies in special color (399) the end caps will be delivered in plastic anthracite-grey solid-colored.

\*\* - Basic price valid for track rail length up to 3000 mm, \*\*corresponding panel width (slow moving panel) up to 1000 mm. - If the track rail length of 3000 mm is exceeded, the surcharge is calculated per additional mm.

- Example possibilities for track rail length 3000 mm:  
Flush pull grip at fast moving panel - all panels can reach a panel width of 1000 mm.  
Handle bar at fast moving panel (handle bar has to be indented by approx. 120 mm) - panel width of slow moving panel 976,70 mm.

LSG accessories, Status-indicator and integrated locking mechanism on pages 144–145.

## Timber door (28 - 50 mm) for installation at wall, 2 and 4 panels

Sliding door fittings

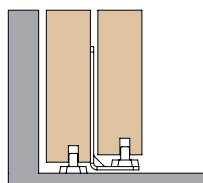

AL anod Silver (150)	AL anod sim. Stain- Steel satin (157)	Al p-coat Traffic white (350)	AL anod Special (199)	AL p-coat Special color (399)  *
-------------------------------	---------------------------------------------------------	-------------------------------------------	--------------------------------	----------------------------------------------------

Art. No.	Description	€/Piece	€/Piece	€/Piece	€/Piece	€/Piece
----------	-------------	---------	---------	---------	---------	---------

**MUTO Premium Telescopic 80**  
**Complete sets, prepared for option with DORMOTION**  
**incl. adapter profile 36.461 / 36.464 for timber door application**

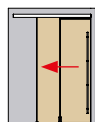

<b>36.725</b>	<b>Set 25</b> Consisting of: 1 profile set Telescopic, incl. adapterprofile for timber panels 4 clamp carriers with anti-jump device endstops incl. safety catch 1 Telescopic rope system <b>1 moving floor guide</b> <b>1 floor guide</b> 2 end caps incl. view protection brushes DIN Right Opening direction left, closing direction right	Basic**	<b>1810,00</b>	<b>1920,00</b>	<b>1810,00</b>	<b>2235,00</b>	<b>2235,00</b>
		Surcharge per mm	<b>0,35</b>	<b>0,35</b>	<b>0,35</b>	<b>0,40</b>	<b>0,40</b>

<b>36.792</b>	<b>Set 25.1</b> do., for installation under lintel resp. with wall connection at 90° from closing direction	Basic**	<b>1810,00</b>	<b>1920,00</b>	<b>1810,00</b>	<b>2235,00</b>	<b>2235,00</b>
		Surcharge per mm	<b>0,35</b>	<b>0,35</b>	<b>0,35</b>	<b>0,40</b>	<b>0,40</b>

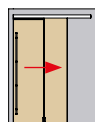

<b>36.726</b>	<b>Set 26</b> Consisting of: 1 profile set Telescopic incl. adapterprofile for timber panels 4 clamp carriers with anti-jump device endstops incl. safety catch 1 Telescopic rope system 1 moving floor guide <b>1 floor guide</b> <b>2 end caps</b> incl. view protection brushes DIN Left Opening direction right, closing direction left	Basic**	<b>1810,00</b>	<b>1920,00</b>	<b>1810,00</b>	<b>2235,00</b>	<b>2235,00</b>
		Surcharge per mm	<b>0,35</b>	<b>0,35</b>	<b>0,35</b>	<b>0,40</b>	<b>0,40</b>

<b>36.793</b>	<b>Set 26.1</b> do., for installation under lintel resp. with wall connection at 90° from closing direction	Basic**	<b>1810,00</b>	<b>1920,00</b>	<b>1810,00</b>	<b>2235,00</b>	<b>2235,00</b>
		Surcharge per mm	<b>0,35</b>	<b>0,35</b>	<b>0,35</b>	<b>0,40</b>	<b>0,40</b>

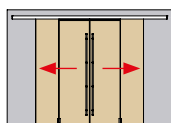

<b>36.733</b>	<b>Set 27</b> Consisting of: 1 profile set Telescopic incl. adapterprofile for timber panels 8 clamp carriers with anti-jump device endstops incl. safety catch 1 Telescopic rope system <b>2 moving floor guides</b> <b>2 floor guides</b> 2 end caps incl. view protection brushes	<b>3617,00</b>	<b>3839,00</b>	<b>3617,00</b>	<b>4470,00</b>	<b>4470,00</b>
---------------	-----------------------------------------------------------------------------------------------------------------------------------------------------------------------------------------------------------------------------------------------------------------------------------------------------------------	----------------	----------------	----------------	----------------	----------------

All MUTO Premium Telescopic 80 units are manufactured to customer specifications. Customisation on site is not possible. Please use our order form, which we will be happy to provide on request (if not available). In the case of an order, you will receive a release drawing.

\* With assemblies in special color (399) the end caps will be delivered in plastic anthracite-grey solid-colored.

\*\* - Basic price valid for track rail length up to 3000 mm, \*\* corresponding panel width (slow moving panel) up to 1000 mm.  
 - If the track rail length of 3000 mm is exceeded, the surcharge is calculated per additional mm.

- Example possibilities for track rail length 3000 mm:  
 Flush pull grip at fast moving panel - all panels can reach a panel width of 1000 mm.  
 Handle bar at fast moving panel (handle bar has to be indented by approx. 120 mm) - panel width of slow moving panel 976,70 mm.

## Timber door ( 28 - 50 mm) for installation at ceiling/with sidelight, 2 and 4 panels

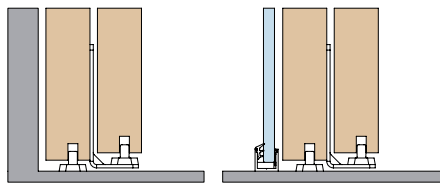

AL anod Silver (150)	AL anod sim. Steel satin (157)	Al p-coat Traffic white (350)	AL anod Special (199)	AL p-coat Special color (399)
€/Piece	€/Piece	€/Piece	€/Piece	€/Piece

Art. No.	Description	€/Piece	€/Piece	€/Piece	€/Piece	€/Piece
----------	-------------	---------	---------	---------	---------	---------

**MUTO Premium Telescopic 80**  
**Complete sets, prepared for option with DORMOTION**  
**incl. adapter profile 36.461 / 36.464 for timber door application**

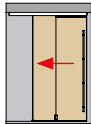

**36.727 Set 28**  
 Consisting of:  
 1 profile set Telescopic  
 incl. adapterprofile for timber panels  
 4 clamp carriers with anti-jump device  
 endstops incl. safety catch  
 1 Telescopic rope system  
**1 moving floor guide**  
**1 floor guide**  
 2 end caps  
 incl. view protection brushes  
 DIN Right  
 Opening direction left, closing direction right

Basic**	1810,00	1920,00	1810,00	2235,00	2235,00
Surcharge per mm	0,35	0,35	0,35	0,40	0,40

**36.794 Set 28.1**  
 do., for installation under lintel resp. with wall connection at 90° from closing direction

Basic**	1810,00	1920,00	1810,00	2235,00	2235,00
Surcharge per mm	0,35	0,35	0,35	0,40	0,40

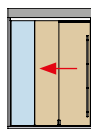

**36.728 Set 29**  
 incl. sidelight  
 Consisting of:  
 1 profile set Telescopic  
 incl. adapterprofile for timber panels  
 4 clamp carriers with anti-jump device  
 endstops incl. safety catch  
 1 Telescopic rope system  
**1 moving floor guide**  
**1 floor guide**  
 2 end caps  
 incl. view protection brushes  
 DIN Right  
 Opening direction left, closing direction right

Basic**	2079,00	2222,00	2079,00	2619,00	2619,00
Surcharge per mm	0,35	0,35	0,35	0,40	0,40

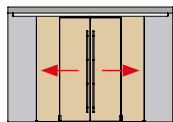

**36.734 Set 30**  
 Consisting of:  
 1 profile set Telescopic  
 8 clamp carriers with anti-jump device  
 endstops incl. safety catch  
 1 Telescopic rope system  
**2 moving floor guides**  
**2 floor guides**  
 2 end caps incl. view protection brushes

3617,00	3839,00	3617,00	4470,00	4470,00
---------	---------	---------	---------	---------

**Single components (optional)**

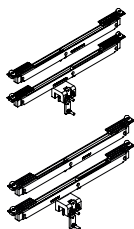

**36.786 MUTO Premium Telescopic 80 DORMOTION unit 2021**  
 for panel weights exceeding 80 kg (fast moving plus slow moving panel)

(000)	242,00
-------	--------

**36.361 MUTO Comfort L 80 DORMOTION unit 2021**  
 for panel weights up to 80 kg (fast moving plus slow moving panel)

(000)	107,00
-------	--------

All MUTO Premium Telescopic 80 units are manufactured to customer specifications. Customisation on site is not possible. Please use our order form, which we will be happy to provide on request (if not available). In the case of an order, you will receive a release drawing.

\* With assemblies in special color (399) the end caps will be delivered in plastic anthracite-grey solid-colored.

\*\* - Basic price valid for track rail length up to 3000 mm, corresponding panel width (slow moving panel) up to 1000 mm. - If the track rail length of 3000 mm is exceeded, the surcharge is calculated per additional mm.

- Example possibilities for track rail length 3000 mm:  
 Flush pull grip at fast moving panel - all panels can reach a panel width of 1000 mm.  
 Handle bar at fast moving panel (handle bar has to be indented by approx. 120 mm) - panel width of slow moving panel 976,70 mm.

LSG accessories, Status-indicator and integrated locking mechanism on pages 144–145.

## Timber door ( 28 - 50 mm) for installation at ceiling/with sidelight, 2 and 4 panels

Sliding door fittings

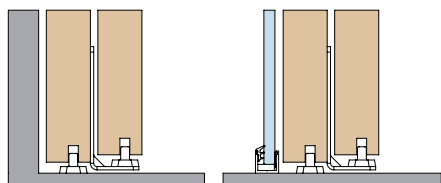

AL anod Silver (150)	AL anod sim. Stain- Steel satin (157)	Al p-coat Traffic white (350)	AL anod Special (199)	AL p-coat Special color (399) *
-------------------------------	---------------------------------------------------------	-------------------------------------------	--------------------------------	------------------------------------------------

Art. No.	Description	€/Piece	€/Piece	€/Piece	€/Piece	€/Piece
----------	-------------	---------	---------	---------	---------	---------

**MUTO Premium Telescopic 80**  
**Complete sets, prepared for option with DORMOTION**  
**incl. adapter profile 36.461 / 36.464 for timber door application**

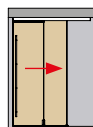

<b>36.729</b>	<b>Set 31</b> Consisting of: 1 profile set Telescopic incl. adapterprofile for timber panels 4 clamp carriers with anti-jump device endstops incl. safety catch 1 Telescopic rope system <b>1 moving floor guide</b> <b>1 floor guide</b> 2 end caps incl. view protection brushes DIN Left Opening direction right, closing direction left	Basic**	<b>1810,00</b>	<b>1920,00</b>	<b>1810,00</b>	<b>2235,00</b>	<b>2235,00</b>
		Surcharge per mm	<b>0,35</b>	<b>0,35</b>	<b>0,35</b>	<b>0,40</b>	<b>0,40</b>

<b>36.795</b>	<b>Set 31.1</b> do., for installation under lintel resp. with wall connection at 90° from closing direction	Basic**	<b>1810,00</b>	<b>1920,00</b>	<b>1810,00</b>	<b>2235,00</b>	<b>2235,00</b>
		Surcharge per mm	<b>0,35</b>	<b>0,35</b>	<b>0,35</b>	<b>0,40</b>	<b>0,40</b>

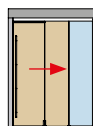

<b>36.730</b>	<b>Set 32</b> incl. sidelight Consisting of: 1 profile set Telescopic incl. adapterprofile for timber panels 4 clamp carriers with anti-jump device endstops incl. safety catch 1 Telescopic rope system <b>1 moving floor guide</b> <b>1 floor guide</b> 2 end caps incl. view protection brushes DIN Left Opening direction right, closing direction left	Basic**	<b>2079,00</b>	<b>2222,00</b>	<b>2079,00</b>	<b>2619,00</b>	<b>2619,00</b>
		Surcharge per mm	<b>0,35</b>	<b>0,35</b>	<b>0,35</b>	<b>0,40</b>	<b>0,40</b>

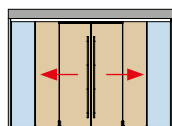

<b>36.735</b>	<b>Set 33</b> incl. sidelight Consisting of: 1 profile set Telescopic incl. adapterprofile for timber panels 8 clamp carriers with anti-jump device endstops incl. safety catch 1 Telescopic rope system <b>2 moving floor guides</b> <b>2 floor guides</b> 2 end caps incl. view protection brushes	<b>4158,00</b>	<b>4444,00</b>	<b>4158,00</b>	<b>5236,00</b>	<b>5236,00</b>
---------------	------------------------------------------------------------------------------------------------------------------------------------------------------------------------------------------------------------------------------------------------------------------------------------------------------------------------------------	----------------	----------------	----------------	----------------	----------------

All MUTO Premium Telescopic 80 units are manufactured to customer specifications. Customisation on site is not possible. Please use our order form, which we will be happy to provide on request (if not available). In the case of an order, you will receive a release drawing.

\* With assemblies in special color (399) the end caps will be delivered in plastic anthracite-grey solid-colored.

\*\* - Basic price valid for track rail length up to 3000 mm, corresponding panel width (slow moving panel) up to 1000 mm. - If the track rail length of 3000 mm is exceeded, the surcharge is calculated per additional mm.

- Example possibilities for track rail length 3000 mm:  
 Flush pull grip at fast moving panel - all panels can reach a panel width of 1000 mm.  
 Handle bar at fast moving panel (handle bar has to be indented by approx. 120 mm) - panel width of slow moving panel 976,70 mm.

## Timber door (28 - 50 mm) with glass overpanel and glass sidelights, 2 and 4 panels

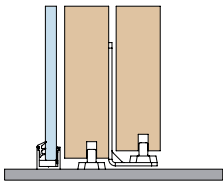

AL anod Silver (150)	AL anod sim. Steel satin (157)	Al p-coat Traffic white (350)	AL anod Special (199)	AL p-coat Special color (399)
€/Piece	€/Piece	€/Piece	€/Piece	€/Piece

Art. No.	Description	€/Piece	€/Piece	€/Piece	€/Piece	€/Piece	
<p><b>MUTO Premium Telescopic 80</b>                      Complete sets, prepared for option with DORMOTION                      incl. adapter profile 36.461 / 36.464 for timber door application</p>							
	<p><b>36.731 Set 34</b>                      incl. sidelight                      Consisting of:                      1 profile set Telescopic                      incl. adapterprofile for timber panels                      4 clamp carriers with anti-jump device                      endstops incl. safety catch                      1 Telescopic rope system  <b>1 moving floor guide</b>  <b>1 floor guide</b>                      2 end caps incl. view protection brushes                      DIN Right                      Opening direction left, closing direction right</p>	Basic**	2098,00	2235,00	2098,00	2609,00	2609,00
		Surcharge per mm	0,35	0,35	0,35	0,40	0,40
	<p><b>36.732 Set 35</b>                      incl. sidelight                      Consisting of:                      1 profile set Telescopic                      incl. adapterprofile for timber panels                      4 clamp carriers with anti-jump device                      endstops incl. safety catch                      1 Telescopic rope system  <b>1 moving floor guide</b>  <b>1 floor guide</b>                      2 end caps incl. view protection brushes                      DIN Left                      Opening direction right, closing direction left</p>	Basic**	2098,00	2235,00	2098,00	2609,00	2609,00
		Surcharge per mm	0,35	0,35	0,35	0,40	0,40
	<p><b>36.736 Set 36</b>                      incl. sidelight                      Consisting of:                      1 profile set Telescopic                      incl. adapterprofile for timber panels                      8 clamp carriers with anti-jump device                      endstops incl. safety catch                      1 Telescopic rope system  <b>2 moving floor guides</b>  <b>2 floor guides</b>                      2 end caps incl. view protection brushes</p>		4197,00	4470,00	4197,00	5221,00	5221,00
	<p><b>Single components (optional)</b></p> <p><b>36.786 MUTO Premium Telescopic 80 DORMOTION unit 2021</b>                      for panel weights exceeding 80 kg (fast moving plus slow moving panel)</p>	(000)	242,00				
	<p><b>36.361 MUTO Comfort L 80 DORMOTION unit 2021</b>                      for panel weights up to 80 kg (fast moving plus slow moving panel)</p>	(000)	107,00				

All MUTO Premium Telescopic 80 units are manufactured to customer specifications. Customisation on site is not possible. Please use our order form, which we will be happy to provide on request (if not available). In the case of an order, you will receive a release drawing.

\* With assemblies in special color (399) the end caps will be delivered in plastic anthracite-grey solid-colored.

\*\* - Basic price valid for track rail length up to 3000 mm, corresponding panel width (slow moving panel) up to 1000 mm. - If the track rail length of 3000 mm is exceeded, the surcharge is calculated per additional mm.

- Example possibilities for track rail length 3000 mm:  
 Flush pull grip at fast moving panel - all panels can reach a panel width of 1000 mm.  
 Handle bar at fast moving panel (handle bar has to be indented by approx. 120 mm) - panel width of slow moving panel 976,70 mm.

LSG accessories, Status-indicator and integrated locking mechanism on pages 144-145.

## MUTO integrated locking mechanism/Status-indicator

Base  
parts  
(000)

Art. No. Description

€/Piece

### Single components

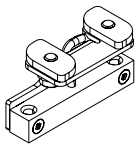

- 36.840 MUTO Status-indicator-Set for Comfort L, Premium XL and Premium Self-Closing**  
consisting of:  
1 Sensor  
1 Receiver  
1 Cable

406,00

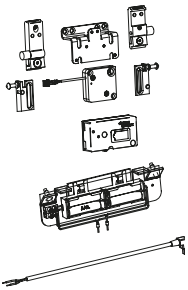

- 36.859 MUTO Integrated locking mechanism, Battery-Version for Premium XL and Premium Self-Closing (no safety lock)**  
consisting of:  
1 Receiver unit  
1 Locking mechanism  
1 Fixing bracket for locking mechanism  
1 Stopper XL, 1 Stopper L  
4 Batteries (ENERGIZER L92 Ultimate Lithium; AAA 1,5V)  
1 Battery carrier  
**Please note: Not applicable for Synchro version.**

700,00

- 36.886 Battery for MUTO Integrated locking mechanism**

24,50

- 36.885 MUTO integrated locking mechanism - Transformer Version**  
for Comfort L, Premium XL, Premium Self-Closing and Premium Telescopic  
(no safety locking)  
Consisting of:  
1 Receiver unit  
1 Locking mechanism  
1 Fixing bracket for locking mechanism  
1 Stopper XL, 1 Stopper L  
1 Transformer, suitable for in-wall socket  
Attention: Not suitable for Synchro version.

831,00

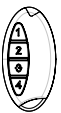

- 36.848 MUTO Remote control for Comfort L, Premium XL and Premium Self-Closing**  
1 Remote control  
1 Battery

123,00

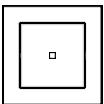

- 36.849 MUTO Wall switch with transmitter for Comfort L, Premium XL and Premium Self-Closing**  
1 Wall switch  
1 Battery

91,00

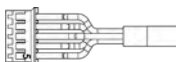

- 36.855 MUTO Status-indicator (Cable-Set) for Comfort L, Premium XL and Premium Self-Closing**  
upgrade of the locking mechanism with a status-indicator







61,50

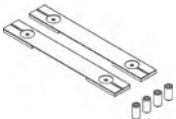
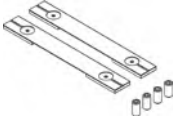
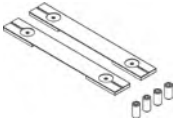
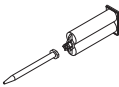
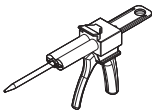
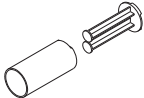
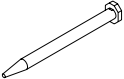
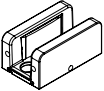

- 29301003 Concealed transmitter dormakaba BRC-T**  
bi-directional flush-mounted radio transmitter dormakaba BRC-T, battery-operated, for installation in a switch with a deep flush-mounting box or a surface-mounted elbow switch/switch pad. Also suitable for heavy-duty applications In conjunction with stainless steel elbow switches.

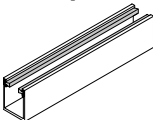

X

## MUTO Accessories

Art. No.	Description	Base parts (000)	AL anod Silver (150)	AL anod sim. Stain-Steel satin (157)	AL p-coat Jet black (304)	AL p-coat Traffic white (350)
		€/Piece	€/Piece	€/Piece	€/Piece	€/Piece
<b>Single components</b>						
	<b>36.939 MUTO Comfort M 60 LSG-Set</b> Accessory set for use of laminated safety glass consisting of: 2 Gaskets 4 Injector screws	12,50				
	<b>36.270 MUTO Comfort L 80 LSG-Set+ Telescopic (slow moving)</b> Accessory set for use of laminated safety glass consisting of: 2 Gaskets 4 Injector screws	13,00				
	<b>36.468 MUTO Premium XL 80/150 LSG-Set</b> Accessory set for use of laminated safety glass consisting of: 2 Gaskets 4 Injector screws	13,50				
	<b>07.631 Special adhesive and mixing jet for use with LSG</b> (sufficient for ca. 10 clamp carriers)	103,00				
	<b>07.629 Automix-Squeezer</b> for use in combination with Art.-No. 07.631	136,00				
	<b>07.628 Automix-Adapter</b> for use in combination with Art. No. 07.631	11,00				
	<b>07.630 Spare mixing jet</b> for use in combination with Art.-No. 07.631	4,00				
	<b>36.105 MUTO Floor guide</b> infinitely adjustable for glass thicknesses up to 13,5 mm	28,50	31,50	31,50	31,50	
	<b>36.787 MUTO Telescopic moving floor guide</b> DIN Right, Opening direction left, closing direction right	134,00	145,00			
	<b>36.788 MUTO Telescopic moving floor guide</b> DIN Left, Opening direction right, closing direction left	134,00	145,00			
	<b>36.791 MUTO Telescopic moving floor guide for timber panels</b>	73,50	78,00			
	<b>MUTO Recessed floor guide profile</b> with brushes stock length 6000 mm	€/Piece 258,00				
	<b>36.562</b> in fixed length	€/m 56,50				
	<b>36.851 MUTO Floor stopp</b> for Comfort M, L and Premium XL for glass- or timber panels	38,00	43,00			
	<b>36.890 MUTO Distance space set (2 pcs.)</b> For installation at ceiling between two walls	30,50				
	<b>36.148 MUTO Comfort / Premium Floor guide for timber door</b>	8,80				

Sliding door fittings

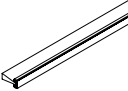
## MUTO Accessories

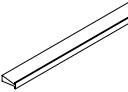
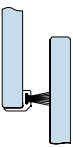
Art. No.	Description	Base parts (000)	AL anod Silver (150)	AL anod sim. Stainl-Steel satin (157)	Al p-coat Traffic white (350)	AL anod Special (199)	AL p-coat Special color (399)
		€/m	€/m	€/m	€/m	€/m	€/m
	<b>Profile for false ceilings</b>		€/Piece	€/Piece	€/Piece	€/Piece	€/Piece
	<b>36.821</b> stock length 6000 mm		<b>147,00</b>	<b>167,00</b>	<b>147,00</b>	<b>201,00</b>	<b>201,00</b>
		€/m					
	<b>36.820</b> in fixed length		<b>30,50</b>	<b>35,00</b>	<b>30,50</b>	<b>41,50</b>	<b>41,50</b>
	<b>MUTO carrier profile with vertical brush sealing</b>						
	fix length up to 4500 mm						
	<b>36.828</b> for gaps 13-16 mm (brush length 13 mm)		<b>20,00</b>	<b>21,00</b>			
	<b>36.829</b> for gaps 16-19 mm (brush length 16 mm)		<b>21,00</b>	<b>21,50</b>			
	<b>36.830</b> for gaps 19-23 mm (brush length 19 mm)		<b>21,00</b>	<b>21,50</b>			
	<b>36.831</b> for gaps 23-27 mm (brush length 23 mm)		<b>21,50</b>	<b>22,00</b>			
	<b>MUTO carrier profile for vertical brush sealings</b>						
	stock length: 4500 mm	€/Piece	<b>69,00</b>	<b>71,00</b>			
	<b>36.826</b>	€/m	<b>19,50</b>	<b>20,00</b>			
	<b>36.827</b> fix length up to 4500 mm						
	<b>MUTO vertical brush sealing</b>						
	fix length up to 4500 mm						
	<b>36.860</b> for gaps 13-16 mm (brush length 13 mm)		<b>0,60</b>				
	<b>36.861</b> for gaps 16-19 mm (brush length 16 mm)		<b>0,80</b>				
	<b>36.862</b> for gaps 19-23 mm (brush length 19 mm)		<b>0,80</b>				
	<b>36.863</b> for gaps 23-27 mm (brush length 23 mm)		<b>1,30</b>				
	<b>MUTO vertical brush sealing</b>	€/Piece					
	<b>36.864</b> for gaps 13-16 mm (300 m roll) (brush length 13 mm)		<b>151,00</b>				
	<b>36.865</b> for gaps 16-19 mm (250 m roll) (brush length 16 mm)		<b>188,00</b>				
	<b>36.866</b> for gaps 19-23 mm (250 m roll) (brush length 19 mm)		<b>188,00</b>				
	<b>36.867</b> for gaps 23-27 mm (150 m roll) (brush length 23 mm)		<b>188,00</b>				
	<b>Aluminium brush profile, for 8 mm glass</b>		(101) €/Piece	(113) €/Piece	(300) €/Piece	€/Piece	€/Piece
	<b>07.402</b> for gaps 14 - 18 mm stock length 3000 mm		<b>33,00</b>	<b>36,50</b>	<b>34,00</b>	<b>38,50</b>	<b>38,50</b>
		€/m					
	<b>07.403</b> fixed length up to 3000 mm		<b>19,50</b>	<b>21,50</b>	<b>18,00</b>	<b>22,00</b>	<b>22,00</b>
	<b>Aluminium brush profile, for 10/12 mm glass</b>		(101) €/Piece	(113) €/Piece	(300) €/Piece	€/Piece	€/Piece
	<b>07.400</b> for gaps 10.5 - 13 mm stock length 3000 mm		<b>33,00</b>	<b>36,50</b>	<b>34,00</b>	<b>38,50</b>	<b>38,50</b>
		€/m					
	<b>07.401</b> fixed length up to 3000 mm		<b>19,50</b>	<b>21,50</b>	<b>18,00</b>	<b>22,00</b>	<b>22,00</b>
	<b>MUTO Premium XL balance profile set, fix length</b>	€/m					
	<b>36.870</b> 12 mm adjustment,		<b>73,00</b>	<b>77,50</b>	<b>73,00</b>	<b>134,00</b>	<b>134,00</b>
	<b>36.871</b> 24 mm adjustment		<b>130,00</b>	<b>140,00</b>	<b>130,00</b>	<b>187,00</b>	<b>187,00</b>
	<b>MUTO Comfort M/L balance profile set, fix length</b>	€/m					
	<b>36.872</b> 12 mm adjustment		<b>69,50</b>	<b>74,50</b>	<b>74,50</b>	<b>130,00</b>	<b>130,00</b>
	<b>36.873</b> 24 mm adjustment		<b>127,00</b>	<b>137,00</b>	<b>127,00</b>	<b>184,00</b>	<b>184,00</b>



# RS 120



Technical data	
Glass	TSG
glass thickness	8, 10, 12 mm
max. door panel weight	120 kg
Applications	1-/2 panels, side lights, Synchro version (Glass- and timber panels)
Material	Aluminium
Finishes	Eloxal and RAL colors
Kind of installation	Installation to wall/ceiling
Specials	Tested acc. DIN EN 1527 no glasspreparation Readjustable without dismantling +5/-5 mm

Example view for RS 120 installation at wall

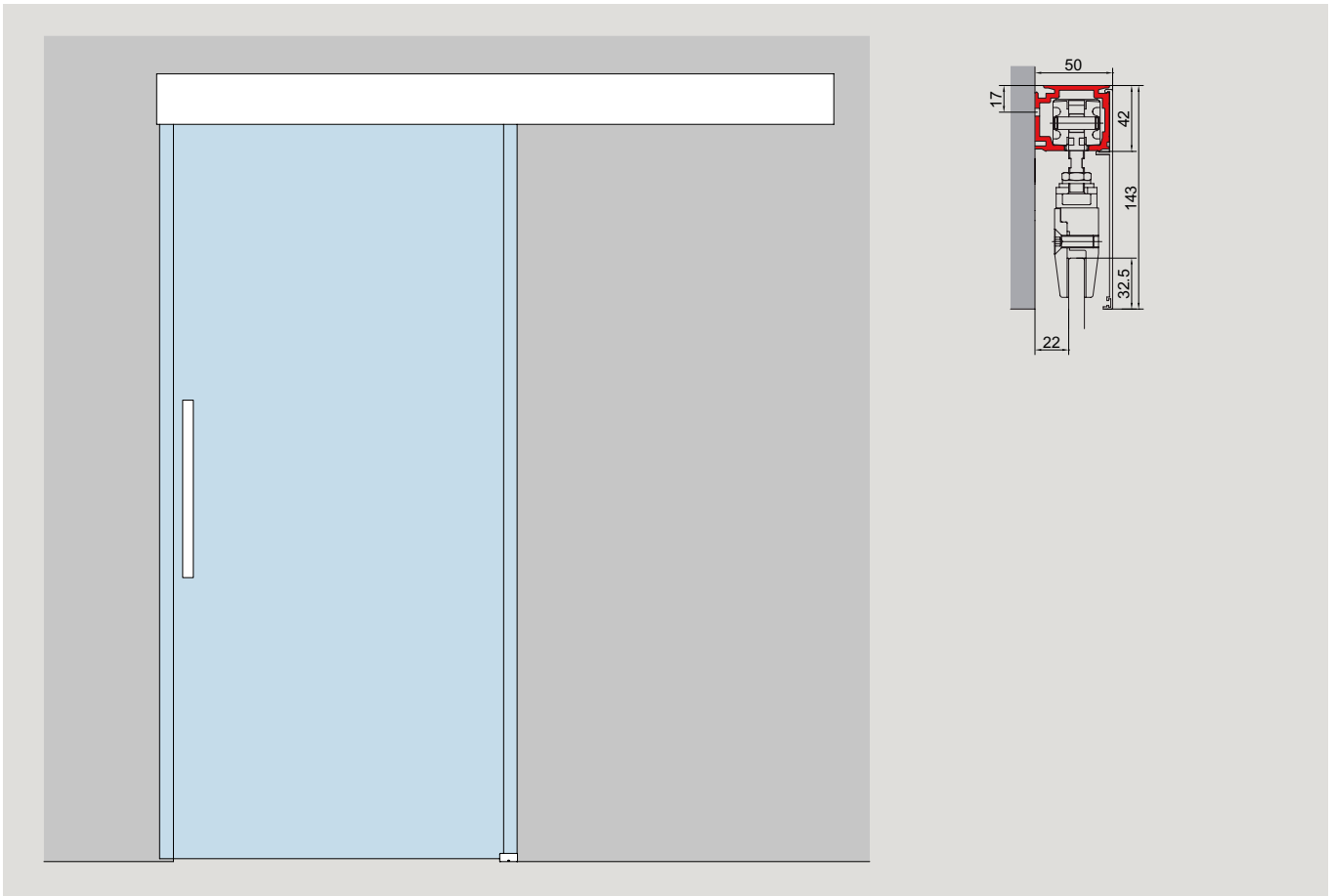

**Example view for RS 120 installation at ceiling**

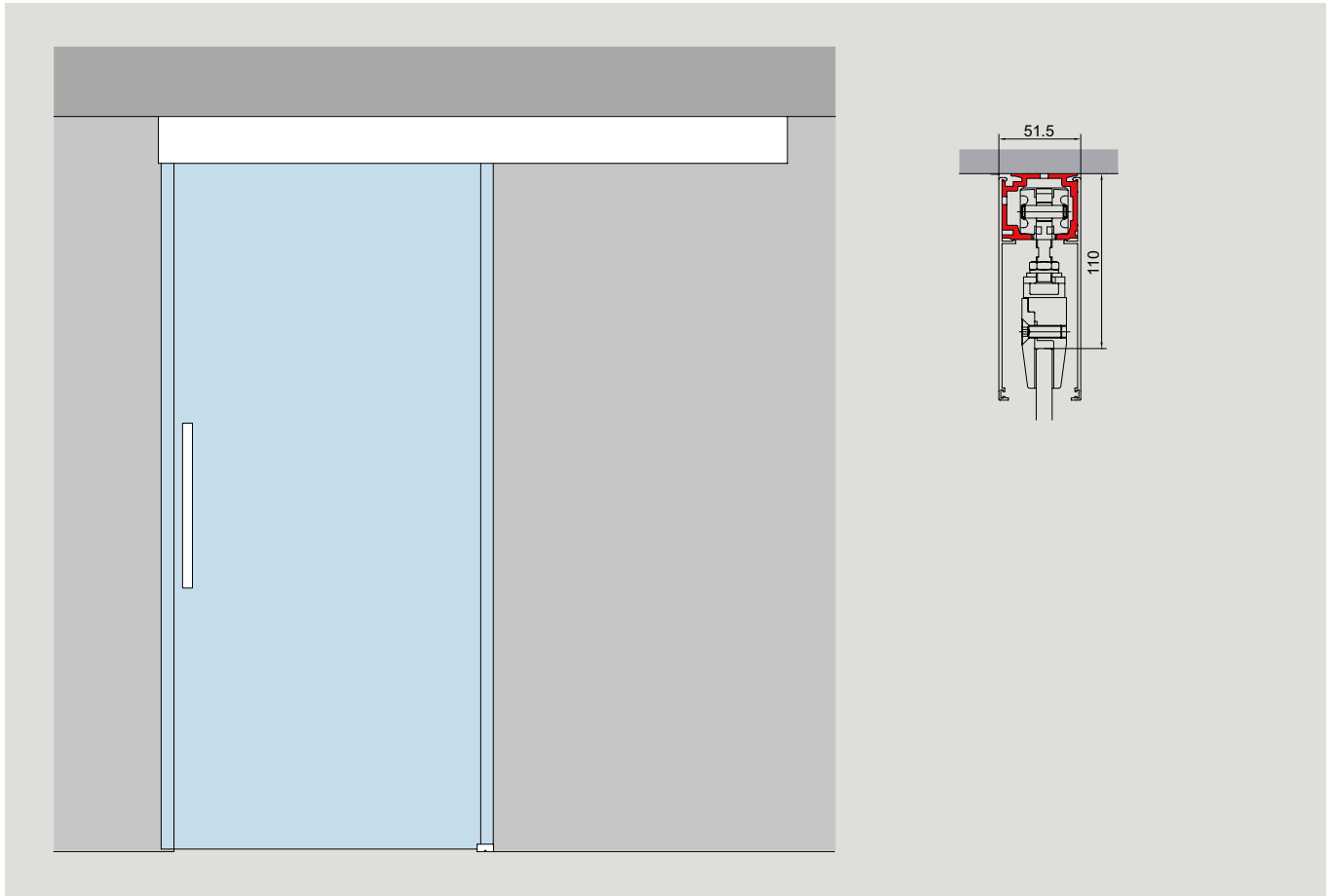

Sliding door fittings

**Example view for RS 120 with glass sidelights**

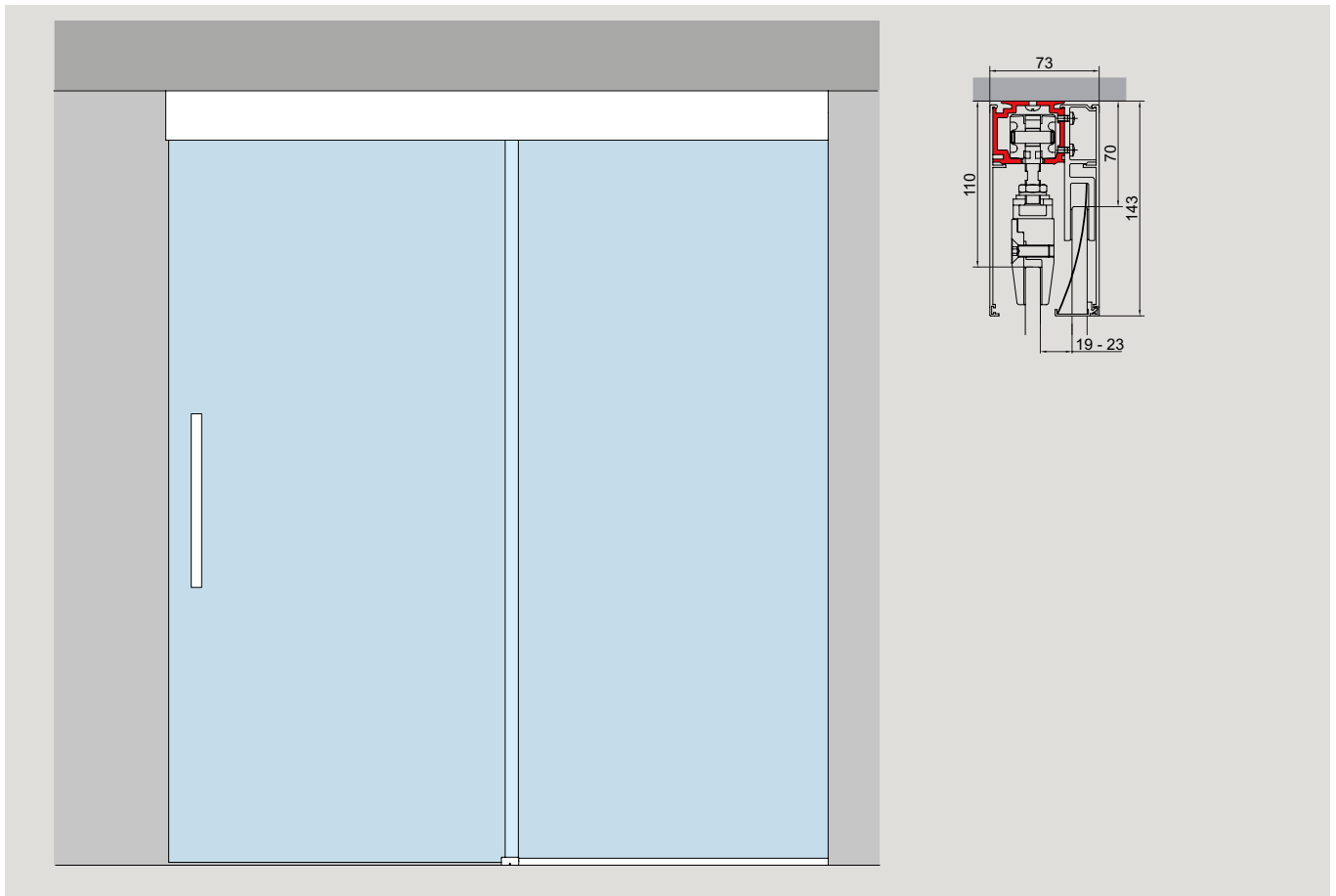

## Glass door (8 and 10 mm) for installation to wall / ceiling

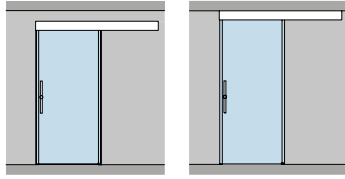

Base parts (000)	LM elox ähnl Niro satin (113)	LM p-besch Verkehrs-weiß (300)	AL anod Special (199)	AL p-coat Special color (399)
------------------	-------------------------------	--------------------------------	-----------------------	-------------------------------

€/Piece	€/Piece	€/Piece	€/Piece	€/Piece
---------	---------	---------	---------	---------

Art. No.	Description
----------	-------------

### Complete sets

**Aluminium track = door width x 2**  
max. panel weight = 120 kg  
for 8 and 10 mm glass thickness

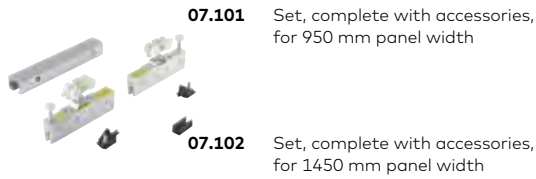

**07.101** Set, complete with accessories, for 950 mm panel width

**285,00**

**07.102** Set, complete with accessories, for 1450 mm panel width

**325,00**

### Set

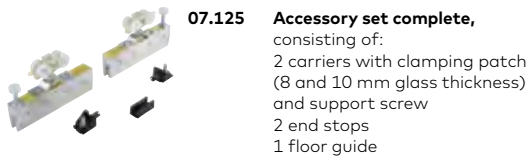

**07.125** **Accessory set complete,** consisting of:  
2 carriers with clamping patch (8 and 10 mm glass thickness) and support screw  
2 end stops  
1 floor guide

**200,00**

### Single components

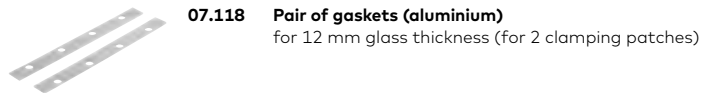

**07.118** **Pair of gaskets (aluminium)** for 12 mm glass thickness (for 2 clamping patches)

**5,40**

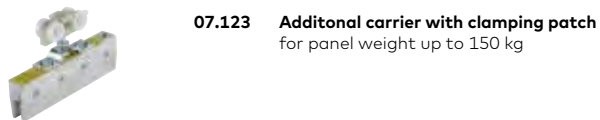

**07.123** **Additional carrier with clamping patch** for panel weight up to 150 kg

**88,00**

**Glass door (8 and 10 mm) for installation to wall / ceiling or with sidelight/s, Synchro**

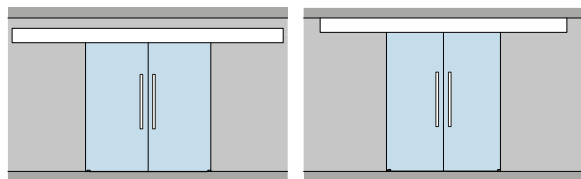

Base parts (000)	LM elox ähnl Niro satin (113)	LM p-besch Verkehrs-weiß (300)	AL anod Special (199)	AL p-coat Special color (399)
------------------	-------------------------------	--------------------------------	-----------------------	-------------------------------

Art. No.	Description	€/Piece	€/Piece	€/Piece	€/Piece	€/Piece
----------	-------------	---------	---------	---------	---------	---------

**Complete sets**

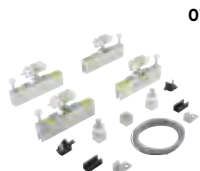

**07.150 RS 120 Synchro Set**  
 For double leaf synchronously opening system,  
 max. panel width = 2 x 1000 mm,  
 max. weight = 80 kg per panel,  
 consisting of:  
 2 x accessory set 07.125  
 1 x deflexion accessory set incl. gear belt

**745,00**

**Track, sidelight profile, cover profile and view protection profile have to be ordered separately**

**Single components**



**07.118 Pair of gaskets (aluminium)**  
 for 12 mm glass thickness (for 2 clamping patches)

**5,40**



**07.123 Additional carrier with clamping patch**  
 for panel weight up to 150 kg

**88,00**

Sliding door fittings

## Glass door (8 and 10 mm) with sidelight/s

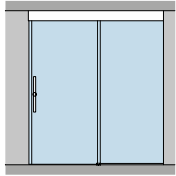

Base parts (000)	LM elox ähnl Niro satin (113)	LM p-besch Verkehrs-weiß (300)	AL anod Special (199)	AL p-coat Special color (399)
------------------	-------------------------------	--------------------------------	-----------------------	-------------------------------

Art. No.	Description	€/Piece	€/Piece	€/Piece	€/Piece	€/Piece
----------	-------------	---------	---------	---------	---------	---------

### Complete sets

**Aluminium track = door width x 2**  
max. panel weight = 120 kg  
for 8 and 10 mm glass thickness

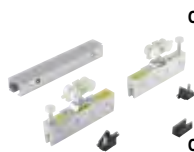

**07.101** Set, complete with accessories, for 950 mm panel width

**285,00**



**07.102** Set, complete with accessories, for 1450 mm panel width

**325,00**

### Set

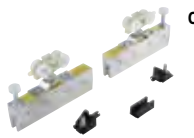

**07.125** **Accessory set complete,** consisting of:  
2 carriers with clamping patch (8 and 10 mm glass thickness) and support screw  
2 end stops  
1 floor guide

**200,00**

### Single components

**07.118** **Pair of gaskets (aluminium)**  
for 12 mm glass thickness (for 2 clamping patches)

**5,40**

**07.123** **Additional carrier with clamping patch**  
for panel weight up to 150 kg

**88,00**

**07.122** **Side panel profile without fixing holes,**  
for 8, 10 and 12 mm glass  
6000 mm stock length

€/m  
**41,50**

**07.132** in fixed length

€/m  
**50,00**

## Timber door for installation at wall and ceiling

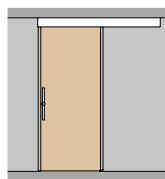
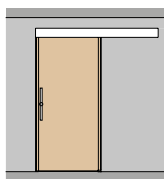

Art. No.	Description	€/m	€/m	€/m	€/m	€/m	€/m
----------	-------------	-----	-----	-----	-----	-----	-----

Base parts (000)	LM elox EV1 (101)	LM elox ähnl Niro satin (113)	LM p-besch Verkehrsweiß (300)	AL anod Special (199)	AL p-coat Special color (399)
------------------	-------------------	-------------------------------	-------------------------------	-----------------------	-------------------------------

### Set

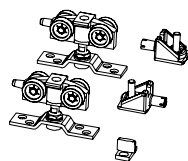

**07.135** **Accessory set complete for timber applications,** consisting of:  
2 carriers  
2 end stops with safety catch  
1 floor guide

€/Piece  
**98,50**

### Single components

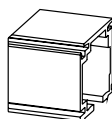

**07.121** **Track with fixing holes**  
6000 mm stock length

**41,50**

**07.131** in fixed length

**50,00**



**07.140** **Cover profile (clip-on)**  
with connecting web for view protection  
cover profile 07.137/138  
6000 mm stock length

**24,50** **42,00** **24,50** **42,00** **42,00**

**07.141** in fixed length

**30,50** **52,50** **30,50** **52,50** **52,50**











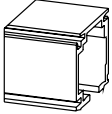

**07.226** **Floor guide for timber door panel**

€/Piece  
**1,10**

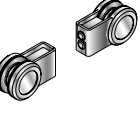
Single components

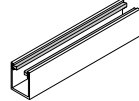
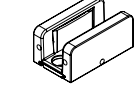
Sliding door fittings

Art. No.	Description	Base parts (000)	LM elox EV1 (101)	LM elox ähnl Niro satin (113)	LM p-besch Verkehrsweiß (300)	AL anod Special (199)	AL p-coat Special color (399)
		€/m	€/m	€/m	€/m	€/m	€/m
<b>Single components</b>							
	<b>07.118</b> <b>Pair of gaskets (aluminium)</b> for 12 mm glass thickness (for 2 clamping patches)	€/Paar <b>5,40</b>					
	<b>07.121</b> <b>Track with fixing holes</b> 6000 mm stock length <b>07.131</b> in fixed length	<b>41,50</b> <b>50,00</b>					
	<b>07.122</b> <b>Side panel profile without fixing holes,</b> for 8, 10 and 12 mm glass 6000 mm stock length <b>07.132</b> in fixed length	<b>41,50</b> <b>50,00</b>					
	<b>07.123</b> <b>Additional carrier with clamping patch</b> for panel weight up to 150 kg	€/Piece <b>88,00</b>					
	<b>07.138</b> <b>Bottom view protection cover profile</b> <b>6000 mm stock length,</b> (only in combination with sidelight profile 07.132 / 122 and cover profile 07.141 / 140)	<b>10,50</b>				<b>16,50</b>	<b>16,50</b>
	<b>07.137</b> <b>Bottom view protection cover profile,</b> <b>in fixed length,</b> (only in combination with sidelight profile 07.132 / 122 and cover profile 07.141 / 140)	<b>12,50</b>			<b>12,50</b>	<b>18,50</b>	<b>18,50</b>
	<b>07.140</b> <b>Cover profile (clip-on)</b> with connecting web for view protection cover profile 07.137/138 6000 mm stock length <b>07.141</b> in fixed length	<b>24,50</b> <b>30,50</b>	<b>42,00</b> <b>52,50</b>	<b>24,50</b> <b>30,50</b>	<b>42,00</b> <b>52,50</b>	<b>42,00</b> <b>52,50</b>	<b>42,00</b> <b>52,50</b>
	<b>29.420</b> <b>Door steady,</b> to prevent glass edges of double sliding doors bumping into each other (glass preparation)	€/Paar <b>78,50</b>					
	<b>07.127</b> <b>Endcap for mounting on wall,</b> including screws, LH/RH	€/Piece <b>21,00</b>	€/Piece <b>30,50</b>	€/Piece <b>21,00</b>	€/Piece <b>30,50</b>	€/Piece <b>30,50</b>	€/Piece <b>30,50</b>
	<b>07.129</b> <b>Endcap for mounting on ceiling</b> including screws, LH/RH	€/Piece <b>21,00</b>	€/Piece <b>30,50</b>	€/Piece <b>21,00</b>	€/Piece <b>30,50</b>	€/Piece <b>30,50</b>	€/Piece <b>30,50</b>
	<b>36.561</b> <b>MUTO Recessed floor guide profile</b> with brushes stock length 6000 mm <b>36.562</b> in fixed length	(150) €/Piece <b>258,00</b> €/m <b>56,50</b>					
	<b>36.105</b> <b>MUTO Floor guide</b> infinitely adjustable for glass thicknesses up to 13,5 mm	(150) €/Piece <b>28,50</b>	(157) €/Piece <b>31,50</b>				
	<b>07.126</b> <b>Floor guide</b>	€/Piece <b>9,20</b>					
	<b>07.226</b> <b>Floor guide for timber door panel</b>	€/Piece <b>1,10</b>					



## Notes

## Notes

# MANET



reddot design award

**Attention:** The products listed in this chapter are intended exclusively for glass construction not requiring approval.



Technical data	
Glass	TSG and LSG (2 x TSG)
Glass thickness	Door panels: 8, 10, 12 and 13.5 mm / Fixed elements: 10, 12 and 13.5 mm
max. door panel weight	100 kg for slidings track tube, 120 kg for drilled sliding track
Applications	1-/2 panels (glass), overpanel, sidelight, toughened glass assembly
Material	Stainless steel AISI 303, (not for indoor swimming pools or salt-water pools)
Finishes	Satin stainless steel
Kind of installation	Installation at wall or glass
Specials	Readjustable without dismantling

Example view for MANET installation at wall

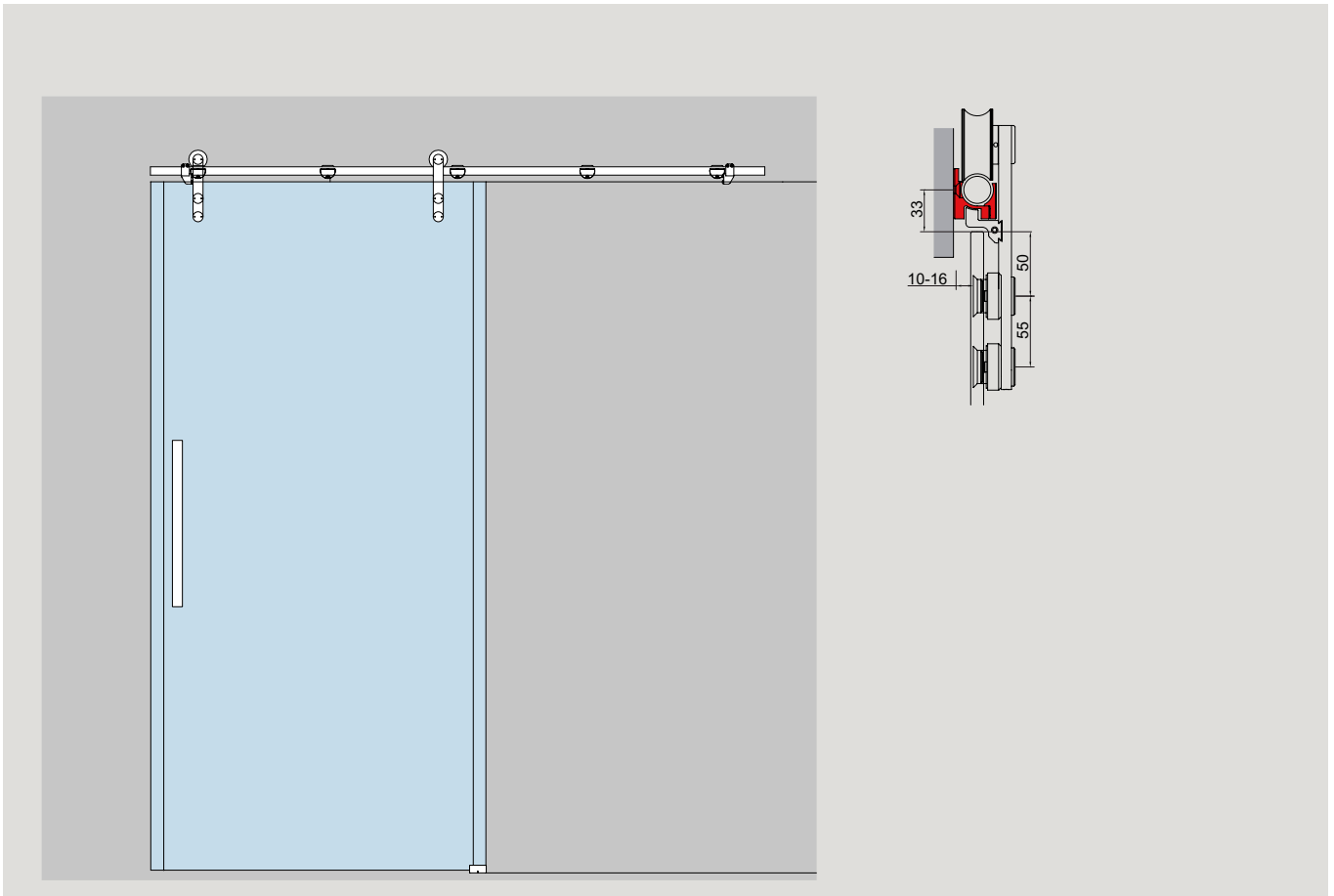

**Example view for MANET with glass overpanel and glass sidelight**

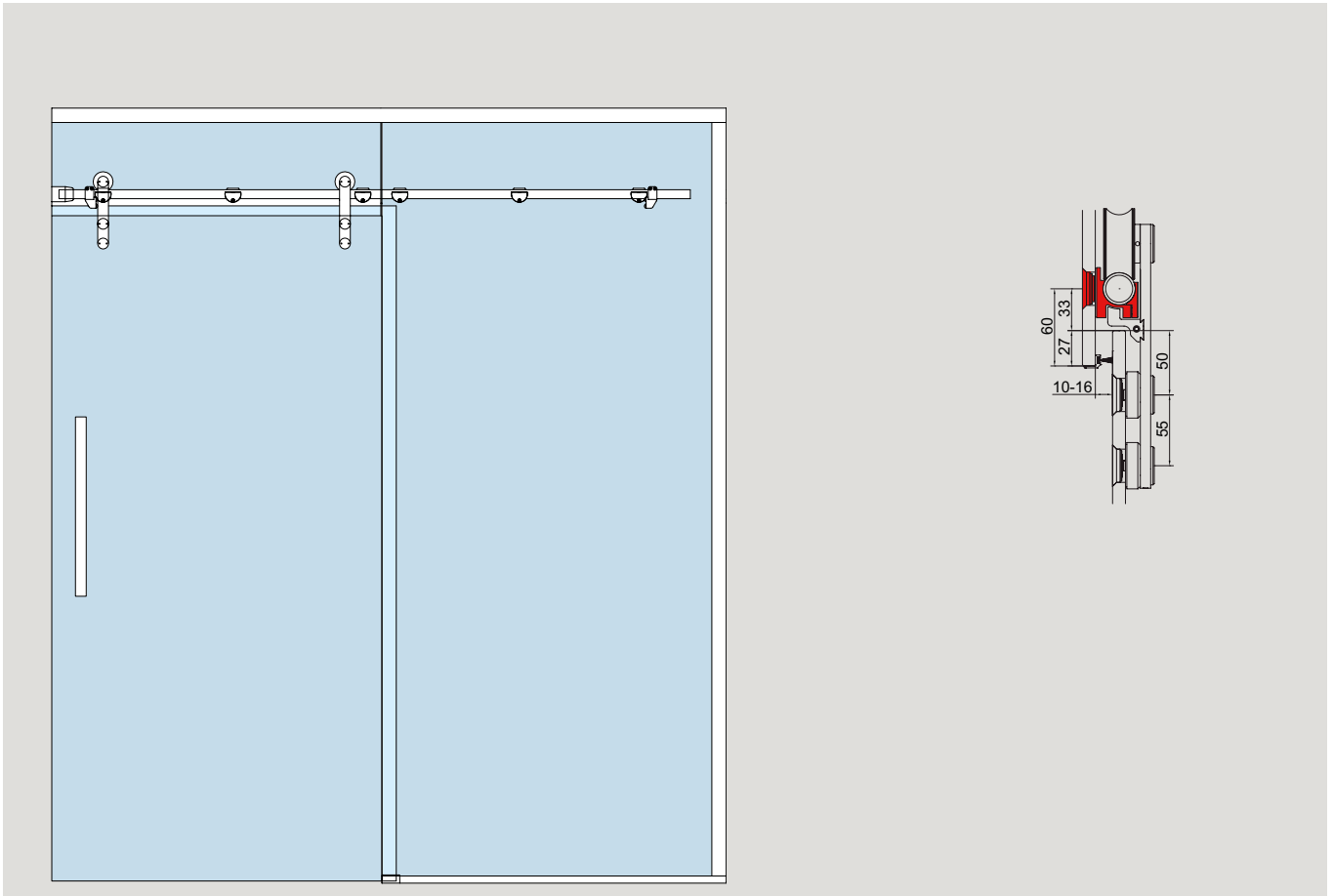

Sliding door fittings

**Example view for MANET with glass overpanel and glass sidelights**

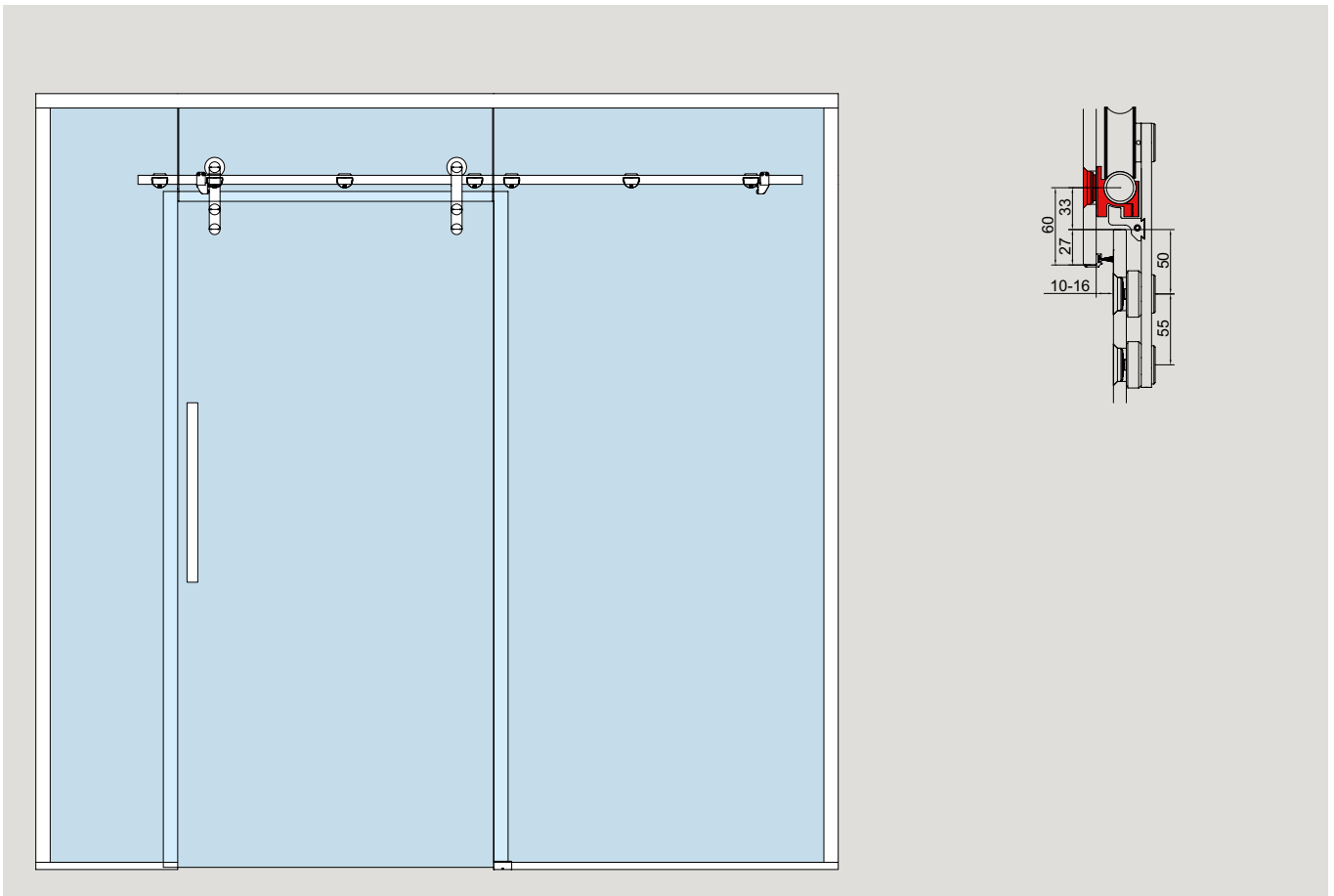

**SET 4.1**

Stainl-Steel satin (700)

Art. No.	Description	€/Piece
<b>Complete set</b>		
<b>Sliding door MANET for mounting to wall for 8 – 13.5 mm glass, countersunk single-point fixings</b>		
29.916	SET 4.1 with clamp brackets for fixing track to wall	<b>885,00</b>

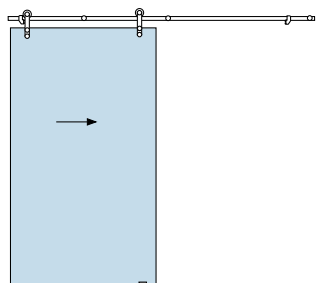

consisting of:  
 5 Clamp brackets track/wall  
 2 Roller Classic carriers incl. single-point fixing 8 – 13.5 mm glass  
 1 Door stop LH  
 1 Door stop RH  
 1 Floor guide

<b>21.436</b>	<b>Not covered by the set:</b> Sliding track tube in fixed length* incl. end plugs	€/m <b>45,00</b>
---------------	---------------------------------------------------------------------------------------	---------------------



\* When ordering please indicate length!

**SET 4.2**

Stainl-Steel satin (700)

Sliding door fittings

Art. No.	Description	€/Piece
<b>Complete set</b>		
<b>Sliding door MANET for mounting to wall for 8 – 13.5 mm glass, clamping disc single-point fixings</b>		
29.917	SET 4.2 with clamp brackets for fixing track to wall	<b>904,00</b>

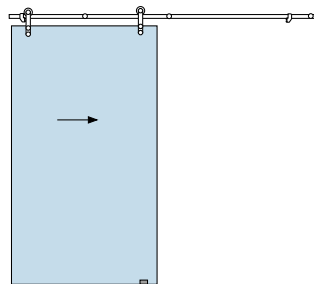

- consisting of:
- 5 Clamp brackets track/wall
  - 2 Roller Classic carriers incl. single-point fixing 8 – 13.5 mm glass
  - 1 Door stop LH
  - 1 Door stop RH
  - 1 Floor guide

21.436	<b>Not covered by the set:</b> Sliding track tube in fixed length* incl. end plugs	€/m <b>45,00</b>
--------	------------------------------------------------------------------------------------------	---------------------



\* When ordering please indicate length!

**SET 5.1**

Stainl-Steel satin (700)

Art. No.	Description	€/Piece
<b>Complete set</b>		
<b>Sliding door MANET for mounting to glass, connected to wall on one side for 8 – 13.5 mm glass (sliding doors), 10 – 13.5 mm glass (fixed elements), countersunk single-point fixings</b>		
29.918	SET 5.1	<b>1047,00</b>

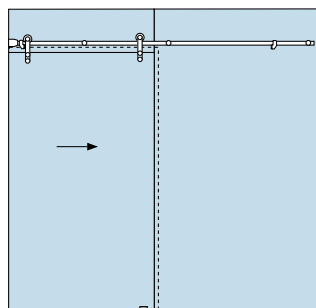

- consisting of:
- 6 Clamp brackets for glass, countersunk single-point fixing
  - 2 Roller Classic carriers incl. single-point fixing 8 - 12 mm glass
  - 1 Wall fixing
  - 1 Door stop LH
  - 1 Door stop RH
  - 1 Floor guide

<b>21.436</b>	<b>Not covered by the set:</b> Sliding track tube in fixed length* incl. end plugs	€/m <b>45,00</b>
---------------	------------------------------------------------------------------------------------------	---------------------



\* When ordering please indicate length!



**SET 5.2**

Stainl-Steel satin (700)

Sliding door fittings

Art. No.	Description	€/Piece
<b>Complete set</b>		
<b>Sliding door MANET for mounting to glass, connected to wall on one side for 8 – 13.5 mm glass (sliding doors), 10 – 13.5 mm glass (fixed elements), clamping disc single-point fixings</b>		
29.919	SET 5.2	<b>1158,00</b>

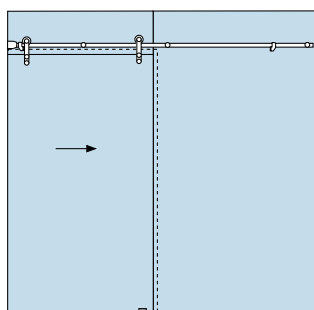

- consisting of:
- 6 Clamp brackets for glass, clamping disc single-point fixing
  - 2 Roller Classic carriers incl. single-point fixing 8 - 13.5 mm glass
  - 1 Wall fixing
  - 1 Door stop LH
  - 1 Door stop RH
  - 1 Floor guide

21.436	<b>Not covered by the set:</b> Sliding track tube in fixed length* incl. end plugs	€/m <b>45,00</b>
--------	------------------------------------------------------------------------------------------	---------------------



\* When ordering please indicate length!

## SET 6.1

Stainl-  
Steel  
satin  
(700)

Art. No.	Description	€/Piece
----------	-------------	---------

**Complete set**

**Sliding door MANET**  
for mounting to glass,  
sidelight both sides  
for 8 – 13.5 mm glass (sliding doors),  
10 – 13.5 mm glass (fixed elements),  
countersunk single-point fixings

29.920 SET 6.1

1097,00

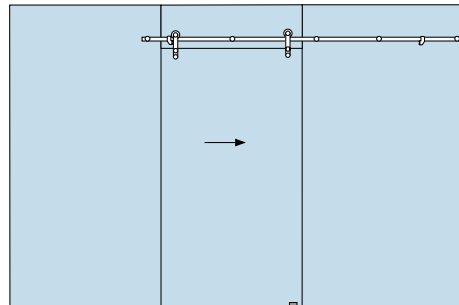

consisting of:

- 7 Clamp brackets for glass, countersunk single-point fixing
- 2 Roller Classic carriers incl. single-point fixing 8 – 13.5 mm glass
- 1 Door stop LH
- 1 Door stop RH
- 1 Floor guide

**21.436 Not covered by the set:**  
Sliding track tube in fixed length\*  
incl. end plugs

€/m  
45,00

\* When ordering please indicate length!

**SET 6.2**

Stainl-Steel satin (700)

Sliding door fittings

Art. No.	Description	€/Piece
<b>Complete set</b>		
<b>Sliding door MANET for mounting to glass, sidelight both sides for 8 – 13.5 mm glass (sliding doors), 10 – 13.5 mm glass (fixed elements), clamping disc single-point fixings</b>		
29.921	SET 6.2	<b>1166,00</b>

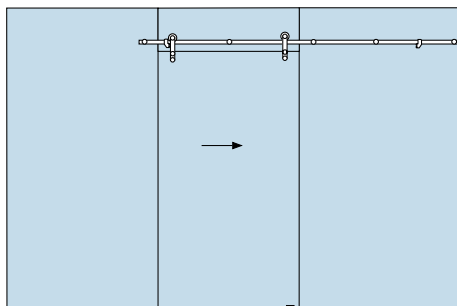

- consisting of:
- 7 Clamp brackets for glass, clamping disc single-point fixing
  - 2 Roller Classic carriers incl. single-point fixing 8 – 13.5 mm glass
  - 1 Door stop LH
  - 1 Door stop RH
  - 1 Floor guide

21.436	<b>Not covered by the set:</b> Sliding track tube in fixed length* incl. end plugs	€/m <b>45,00</b>
--------	------------------------------------------------------------------------------------------	---------------------











\* When ordering please indicate length!







## Single components for Sliding doors

Stainl-  
Steel  
satin  
(700)

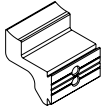
Sliding door fittings

	Art. No.	Description	€/Piece
	<b>21.527</b>	<b>Sliding track tube incl. end caps</b> stock length 3,000 mm	<b>123,00</b>
	<b>21.436</b>	fixed length up to 6,000 m	€/m <b>45,00</b>
	<b>29.176</b>	<b>Clamp bracket, fixing track to glass,</b> countersunk single-point fixing for 10, 12 and 13.5 mm glass	<b>69,50</b>
	<b>29.177</b>	<b>Clamp bracket, fixing track to glass,</b> clamping disc single-point fixing for 10, 12 and 13.5 mm glass	<b>73,50</b>
	<b>29.175</b>	<b>Clamp bracket, fixing track to wall</b>	<b>51,50</b>
	<b>29.178</b>	<b>Clamp bracket, fixing track to wall</b> with 16 mm extended distance between wall and glass	<b>60,00</b>
	<b>29.445</b>	<b>Wall fixing for solid tracks and tubes</b>	<b>53,50</b>
<b>Solid sliding tracks and components</b>			
	<b>21.405</b>	<b>Track drilled</b> fixed length up to 4,200 mm for glass fixing	€/m <b>223,00</b>
	<b>21.406</b>	for wall fixing	<b>241,00</b>
	<b>29.460</b>	<b>Single-point fixing,</b> countersunk, for fixing track to glass overpanel and sidelight in 10 -13.5 mm glass thickness (applicable with glass doors 10 -13.5 mm thickness ) fixed	<b>20,00</b>
	<b>29.462</b>	centred	<b>29,50</b>
	<b>21.346</b>	<b>Flange fixing track to wall</b>	<b>8,00</b>

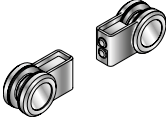
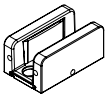
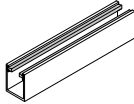



## Single components for Sliding doors

Art. No.	Description	AL anod EV1 (101)	Al p-coat Traffic white (300)	AL anod Special (199)	AL p-coat Special color (399)	AL anod sim. Stain-Steel satin (113)	Stain-Steel satin (700)	€/Piece
	<b>29.422 Roller carrier*</b> only lug with roller including antijump mechanism for tube/solid track  * When ordering the sliding door roller without track no guarantee for the function of the roller will be given.							<b>182,00</b>
	<b>29.221 Anti-jump device</b> Packing unit: 2 Pcs. (For systems with delivery date 01/2012 or later. Older versions on request.)							<b>38,50</b>
	<b>29.430 2 pcs. single-point fixing for roller carrier</b> countersunk for 8 - 13,5 mm glass							<b>44,00</b>
	<b>29.425 Door stop left hand</b>							<b>102,00</b>
	<b>29.426 Door stop right hand</b>							<b>102,00</b>
	<b>29.420 Door steady,</b> to prevent glass edges of double sliding doors bumping into each other							(000) €/Paar <b>78,50</b>
	<b>36.106 MUTO Floor guide</b> infinitely adjustable for glass thicknesses up to 13,5 mm							(157) <b>31,50</b>
	<b>MUTO Recessed floor guide profile</b> with brushes							(150) <b>258,00</b> €/m
	<b>36.561</b> stock length 6000 mm							<b>56,50</b>
	<b>36.562</b> in fixed length							
	<b>Aluminium brush profile,</b> for gaps 14 - 18 mm stock length 3000 mm							<b>33,00</b> €/m
	<b>07.402</b>	<b>34,00</b> €/m	<b>38,50</b> €/m	<b>38,50</b> €/m	<b>36,50</b> €/m			
	<b>07.403</b> fixed length up to 3,000 mm	<b>19,50</b>	<b>18,00</b>	<b>22,00</b>	<b>22,00</b>	<b>21,50</b>		
	<b>Aluminium brush profile,</b> for gaps 10.5 - 13 mm stock length 3000 mm							<b>33,00</b> €/m
	<b>07.400</b>	<b>34,00</b> €/m	<b>38,50</b> €/m	<b>38,50</b> €/m	<b>36,50</b> €/m			
	<b>07.401</b> fixed length up to 3,000 mm	<b>19,50</b>	<b>18,00</b>	<b>22,00</b>	<b>22,00</b>	<b>21,50</b>		

Sliding door fittings







## Single components for Sliding doors

Stain-  
Steel  
satin  
(700)

Art. No.	Description	€/Piece
	<b>29.337 Ceiling connector</b> (carrying function max. 35 kg/piece) for 8 - 13,5 mm glass with countersunk single-point fixing	<b>123,00</b>
	<b>29.145 Glass/ceiling or glass/floor connector 90°</b> for 8 - 13,5 mm glass (only supporting, no carrying function)	<b>78,50</b>
	<b>Glass/glass corner connector 90°-180°</b> for 8 - 13,5 mm glass, with connecting rod 60 mm	<b>95,00</b>
<b>29.122</b>	connecting rod 60 mm	<b>95,00</b>
<b>29.130</b>	connecting rod 103 mm	<b>95,00</b>
	<b>29.140 Glass/wall corner connector 90°-180°</b> for 8 - 13,5 mm glass, with connecting rod 60 mm	<b>102,00</b>

**Connectors**

Base parts (000)    Stain-Steel satin (700)

Art. No.	Description	€/Piece	€/Piece
	<b>21.449</b> <b>Dead lock with profile cylinder rose</b> on inside für 8 - 13,5 mm glass		<b>185,00</b>
	<b>05.194</b> <b>Eccentric bushing</b> for dead lock 21.449	<b>28,00</b>	
	<b>14.206</b> <b>Profile cylinder, 66 mm cylinder length (30,5 + 35,5 mm)</b> for dead lock 21.449	<b>26,00</b>	
	<b>05.190</b> <b>Strike plate</b>	<b>16,50</b>	
	<b>29.217</b> 5 pcs. of <b>clip-on cover</b> with spring for single-point fixing		<b>26,00</b>
	<b>21.134</b> <b>Assembling tool for MANET single-point fixings</b>	<b>15,00</b>	

Sliding door fittings

# STUDIO Rondo

Glass door fittings single-action



Technical data	
Glass	TSG
Glass thickness	8 mm (in frames with 24 mm rebate depth) 10 mm (in frames with 26 mm rebate depth; with special latch on request also in frames with 24 mm rebate depth)
max. door weight	45 to 60 kg (depending on the combination of STUDIO hinges and frame parts used) / upto 80 kg (depending on the combination of OFFICE hinges and frame parts used)
Lock application	non-locking latch, profile cylinder, warded key, toilet lock, round cylinder
Applications	1-/2 panels, sidelight
Material	Aluminium, Brass
Finishes	Anodised- and RAL-Colors (coated), Brass color finishes
Specials	Tested acc. DIN EN 12209, Lock insert with „low-noise-whisper“ functionality, Adjustable lever handle follower (with the exception of „Non-locking latch, lever forward“)



## Manual single action door systems

### STUDIO

- 104 STUDIO Rondo
- 112 STUDIO Classic
- 118 STUDIO Gala 2.0
- 124 STUDIO Arcos
- 130 STUDIO1121
- 134 STUDIO Medio

### OFFICE

- 138 OFFICE Junior
- 144 OFFICE Classic
- 150 OFFICE Mundus
- 154 OFFICE Arcos

### 157 Special hinges

#### General accessories for the single action door range

- 162 Frame pivots for internal doors
- 164 Frame pockets, push-on sleeves, strike plates, door stop EASY Stop
- 166 Door rails for internal doors
- 169 Floor bearings, profile cylinders, door bolts, door catches, floor sockets

#### Example view for STUDIO Rondo

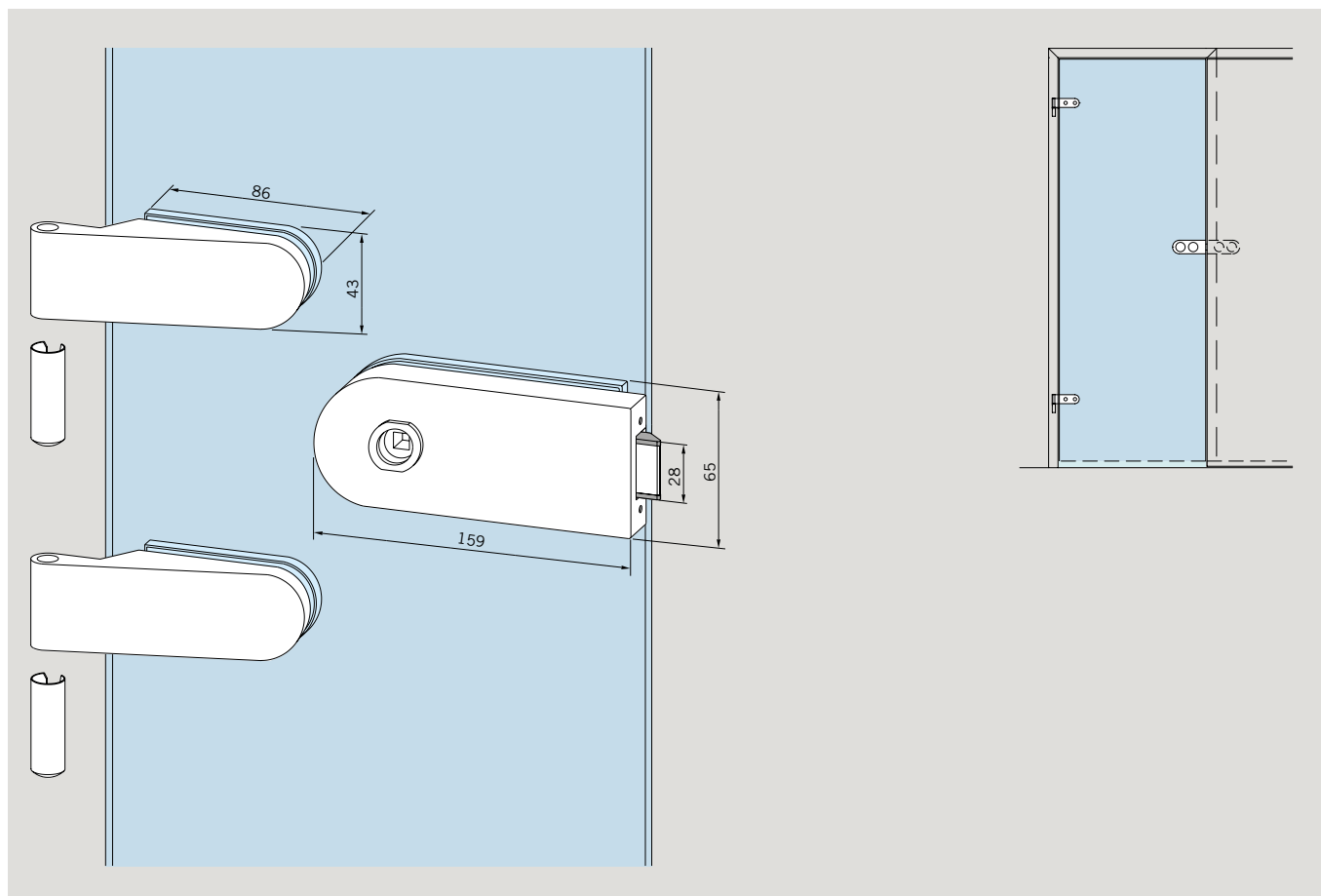

## Complete sets



Art. No.	Description	AL anod Silver (150)	AL anod sim. Stainl-Steel satin (157)	AL p-coat Jet black (304)
		€/Piece	€/Piece	€/Piece
<p><b>With follower for 8, 10 mm glass thickness (door weight 55 kg)</b></p>				
51.739	<p><b>Combination: STUDIO Rondo Lock &amp; OFFICE Classic hinges</b> STUDIO Rondo Lock non-locking latch, without lever, for lever forward, with follower for 8/10 mm glass thickness, incl. 2 OFFICE Junior hinges and sleeves, 2 frame parts for wooden frames</p>	175,00	234,00	234,00
51.740	<p><b>Combination: STUDIO Rondo Lock &amp; OFFICE Classic hinges</b> STUDIO Rondo Lock profile cylinder, without lever, with follower for 8/10 mm glass thickness, incl. 2 OFFICE Junior hinges and sleeves, 2 frame parts for wooden frames</p>	175,00	234,00	234,00
51.741	<p><b>Combination: STUDIO Rondo Lock &amp; OFFICE Junior hinges</b> STUDIO Rondo Lock warded key, without lever, with follower for 8/10 mm glass thickness, incl. 2 OFFICE Junior hinges and sleeves, 2 frame parts for wooden frames</p>	175,00	234,00	234,00

**Application of 10 mm glass thickness at 24 mm rebate depth possible (special latch on request)**

Complying to the current DIN EN 12209.  
Separately and successfully tested with 200,000 latch and 200,000 locking bolt operating cycles..

All locks with low noise whisper functionality.  
Plus adjustable handle follower +1,5°-1°  
(with the exception of „Non-locking latch, lever forward“).

## Sets (locks, hinges and sleeves)

Art. No.	Description	AL anod Silver (150) €/Piece	AL anod sim. Stain-Steel satin (157) €/Piece	AL anod Special (199) €/Piece	AL p-coat Special color (399) €/Piece
<b>With follower for 8 mm glass thickness</b>					
	10.100 Non-locking latch	147,00	211,00	265,00	251,00
	10.101 Non-locking latch, lever forward	147,00	211,00	265,00	251,00
	10.102 Prepared for profile cylinder	147,00	211,00	265,00	251,00
	10.108 Prepared for round cylinder			296,00	282,00
	10.103 Warded key	147,00	211,00	265,00	251,00
	10.106 Toilet lock	197,00	274,00	321,00	305,00
	10.120 Strike-box	155,00	223,00	277,00	264,00
<b>With follower for 10 mm glass thickness</b>					
	10.130 Non-locking latch	149,00	214,00	268,00	256,00
	10.131 Non-locking latch, lever forward	149,00	214,00	268,00	256,00
	10.132 Prepared for profile cylinder	149,00	214,00	268,00	256,00
	10.129 Prepared for round cylinder			303,00	288,00
	10.133 Warded key	149,00	214,00	268,00	256,00
	10.134 Toilet lock	200,00	277,00	325,00	309,00
	10.125 Strike-box	158,00	228,00	281,00	267,00

**Application of 10 mm glass thickness at 24 mm rebate depth possible (special latch on request)**

Complying to the current DIN EN 12209.  
Separately and successfully tested with 200,000 latch and 200,000 locking bolt operating cycles..

All locks with low noise whisper functionality.  
Plus adjustable handle follower +1,5°-1°  
(with the exception of „Non-locking latch, lever forward“).

## Sets (locks, hinges and sleeves)







Art. No.	Description	AL anod Silver (150)	AL anod sim. Stainl-Steel satin (157)	AL anod Special (199)	AL p-coat Special color (399)
		€/Piece	€/Piece	€/Piece	€/Piece
<b>For levers with roses for 8 mm glass thickness</b>					
	<b>10.110</b> Non-locking latch	174,00	248,00	310,00	294,00
	<b>10.111</b> Non-locking latch, lever forward	174,00	248,00	310,00	294,00
	<b>10.112</b> Prepared for profile cylinder	174,00	248,00	310,00	294,00
	<b>10.118</b> Prepared for round cylinder			342,00	327,00
	<b>10.113</b> Warded key	174,00	248,00	310,00	294,00
	<b>10.120</b> Strike-box	155,00	223,00	277,00	264,00
	<b>10.125</b> Strike-box for 10 mm glass thickness	158,00	228,00	281,00	267,00

### Application of 10 mm glass thickness at 24 mm rebate depth possible (special latch on request)

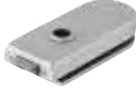
Complying to the current DIN EN 12209.  
Separately and successfully tested with 200,000 latch and 200,000 locking bolt operating cycles..

All locks with low noise whisper functionality.  
Plus adjustable handle follower +1,5°-1°  
(with the exception of „Non-locking latch, lever forward“).

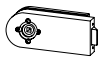

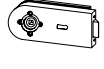
## Single components

		AL anod Silver (150)	AL anod sim. Stainl-Steel satin (157)	AL p-coat Jet black (304)	AL anod Special (199)	AL p-coat Special color (399)
Art. No.	Description	€/Piece	€/Piece	€/Piece	€/Piece	€/Piece
<b>Locks with follower for 8 – 10 mm glass thickness</b>						
	10.200 Non-locking latch	102,00	145,00	145,00	185,00	176,00
	10.201 Non-locking latch, lever forward	102,00	145,00	145,00	185,00	176,00
	10.202 Prepared for profile cylinder	102,00	145,00	145,00	185,00	176,00
	10.203 Warded key	102,00	145,00	145,00	185,00	176,00
	10.207 Prepared for round cylinder	136,00	178,00		219,00	209,00
	10.206 Toilet lock	157,00	213,00	213,00	242,00	231,00
	10.220 Strike-box	111,00	156,00	156,00	200,00	188,00
<b>Locks for levers with roses for 8 – 10 mm glass thickness</b>						
	10.210 Non-locking latch	131,00	185,00		236,00	223,00
	10.211 Non-locking latch, lever forward	131,00	185,00		236,00	223,00
	10.212 Prepared for profile cylinder	131,00	185,00		236,00	223,00
	10.213 Warded key	131,00	185,00		236,00	223,00
	10.217 Prepared for round cylinder				270,00	258,00

Application of 10 mm glass thickness at 24 mm rebate depth possible (special latch on request)

All locks with low noise whisper functionality. Plus adjustable handle follower +1,5°-1° (with the exception of „Non-locking latch, lever forward“).

## Single components

Art. No.	Description	DIN	AL	AL	AL	AL	AL		
			anod Silver (150)	anod sim. Stain-Steel satin (157)	p-coat Jet black (304)	anod Special (199)	p-coat Special color (399)	€/Piece	€/Piece
<b>Door hinges for 8 mm glass thickness</b>									
	<b>10.230</b> Rondo, incl. sleeve		30,50	41,00	41,00	53,50	50,00		
	<b>10.234</b> Door hinges with sleeve and filling piece for 40 mm rebate depth (Please indicate glass thickness)		44,50	63,00		77,00	73,50		
	<b>10.232</b> Hinge STUDIO Rondo with frame pivot for wooden frames		51,00	92,00		92,00	88,00		
	<b>10.235</b> Hinge STUDIO Rondo with frame pivot for wooden frames, strengthened version		67,00	119,00		119,00	113,00		
	<b>10.233</b> Door hinges for 28–30 mm rebate depth (Please indicate glass thickness and rebate depth)		60,50	85,50		99,50	93,50		
	<b>10.420</b> Filling piece with screws suitable for 10.230 for 31 – 39 mm rebate depth (Please indicate glass thickness and rebate depth)		31,50	43,00		46,50	46,50		
	<b>10.244</b> Hinge, glass to glass	LH	96,00	145,00		145,00	137,00		
	<b>10.246</b> do.	RH	96,00	145,00		145,00	137,00		

## Single components

Art. No.	Description	DIN	AL	AL	AL	AL	AL		
			anod Silver (150)	anod sim. Stainl- Steel satin (157)	p-coat Jet black (304)	anod Special (199)	p-coat Special color (399)	€/Piece	€/Piece
<b>Door hinges for 10 mm glass thickness</b>									
	<b>10.236</b> Rondo, incl. sleeve		31,50	42,00	41,00	55,50	52,50		
	<b>10.238</b> Hinge STUDIO Rondo with frame pivot for wooden frames		53,50	93,00		93,00	89,00		
	<b>10.239</b> Hinge STUDIO Rondo with frame pivot for wooden frames, strengthened version		68,50	120,00		120,00	114,00		
	<b>10.234</b> Door hinges with sleeve and filling piece for 40 mm rebate depth (Please indicate glass thickness)		44,50	63,00		77,00	73,50		
	<b>10.233</b> Door hinges for 28 – 30 mm rebate depth (Please indicate glass thickness)		60,50	85,50		99,50	93,50		
	<b>10.420</b> Filling piece with screws suitable for 10.230 for 31 – 39 mm rebate depth (Please indicate glass thickness)		31,50	43,00		46,50	46,50		
	<b>10.245</b> Hinge, glass to glass fixing	LH	98,00	146,00		146,00	138,00		
	<b>10.247</b> Hinge, glass to glass fixing	RH	98,00	146,00		146,00	138,00		
	<b>10.424</b> Frame pivot for wooden frames/STUDIO		(000) 6,10						

Further frame parts on pages 162 – 163

# STUDIO Classic

Glass door fittings single-action



Technical data	
Glass	TSG
Glass thickness	8 mm (in frames with 24 mm rebate depth) 10 mm (in frames with 26 mm rebate depth; with special latch on request also in frames with 24 mm rebate depth)
max. door weight	45 to 60 kg (depending on the combination of STUDIO hinges and frame parts used) / upto 80 kg (depending on the combination of OFFICE hinges and frame parts used)
Lock application	non-locking latch, profile cylinder, warded key, toilet lock, round cylinder
Applications	1-/2 panels, sidelight
Material	Aluminium
Finishes	Anodised- and RAL-Colors (coated)
Specials	Tested acc. DIN EN 12209, Lock insert with „low-noise-whisper“ functionality, Adjustable lever handle follower (with the exception of „Non-locking latch, lever forward“)



## Manual single action door systems

### STUDIO

- 104 STUDIO Rondo
- 112 STUDIO Classic
- 118 STUDIO Gala 2.0
- 124 STUDIO Arcos
- 130 STUDIO1121
- 134 STUDIO Medio

### OFFICE

- 138 OFFICE Junior
- 144 OFFICE Classic
- 150 OFFICE Mundus
- 154 OFFICE Arcos

### 157 Special hinges

#### General accessories for the single action door range

- 162 Frame pivots for internal doors
- 164 Frame pockets, push-on sleeves, strike plates, door stop EASY Stop
- 166 Door rails for internal doors
- 169 Floor bearings, profile cylinders, door bolts, door catches, floor sockets

#### Example view for STUDIO Classic

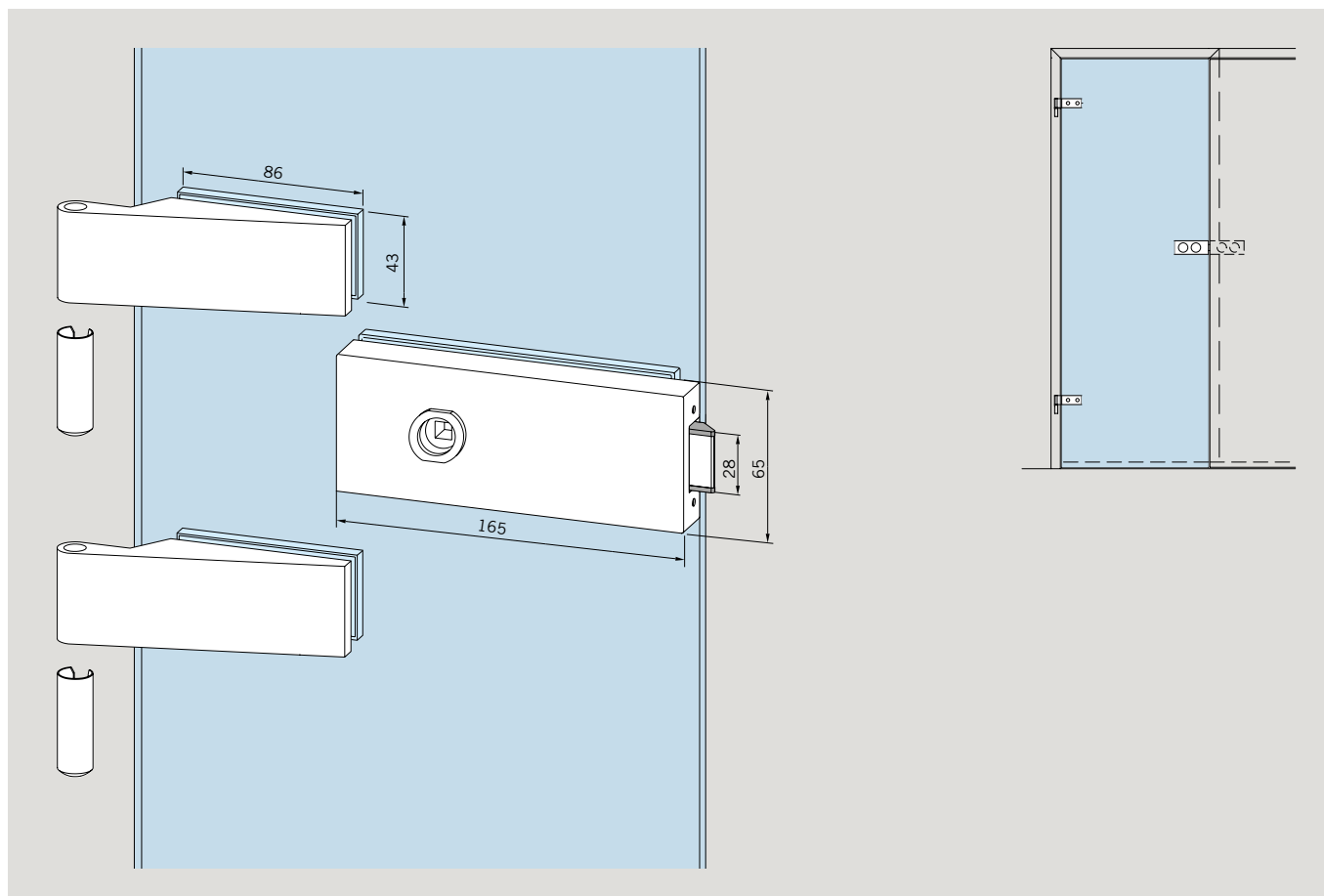

Complete sets

AL anod Silver (150)  
 AL anod sim. Stainl-Steel satin (157)  
 AL p-coat Jet black (304)

Art. No. Description €/Piece €/Piece €/Piece

Glass door fittings single-action

**With follower for 8, 10 mm glass thickness (door weight 55 kg))**

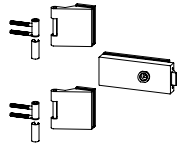
	<p><b>51.746</b> <b>Combination:</b>  <b>STUDIO Classic Lock &amp; OFFICE Classic hinges</b>                  STUDIO Classic lock non-locking latch, without lever, for lever forward, with follower for 8/10 mm glass thickness, incl. 2 OFFICE Classic hinges and sleeves, 2 frame parts for wooden frames</p>	<p><b>175,00</b> <b>234,00</b> <b>234,00</b></p>
----------------------------------------------------------------------------------	--------------------------------------------------------------------------------------------------------------------------------------------------------------------------------------------------------------------------------------------------------------------------------------------------------------------------	--------------------------------------------------

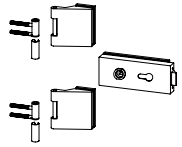
	<p><b>51.747</b> <b>Combination:</b>  <b>STUDIO Classic Lock &amp; OFFICE Classic hinges</b>                  STUDIO Classic lock profile cylinder, without lever, with follower for 8/10 mm glass thickness, incl. 2 OFFICE Junior hinges and sleeves, 2 frame parts for wooden frames</p>	<p><b>175,00</b> <b>234,00</b> <b>234,00</b></p>
-----------------------------------------------------------------------------------	-----------------------------------------------------------------------------------------------------------------------------------------------------------------------------------------------------------------------------------------------------------------------------------------------------	--------------------------------------------------

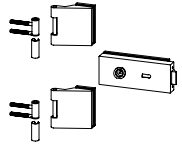

	<p><b>51.748</b> <b>Combination:</b>  <b>STUDIO Classic Lock &amp; OFFICE Classic hinges</b>                  STUDIO Classic lock warded key, without lever, with follower for 8/10 mm glass thickness, incl. 2 OFFICE Classic hinges and sleeves, 2 frame parts for wooden frames</p>	<p><b>175,00</b> <b>234,00</b> <b>234,00</b></p>
------------------------------------------------------------------------------------	------------------------------------------------------------------------------------------------------------------------------------------------------------------------------------------------------------------------------------------------------------------------------------------------	--------------------------------------------------

**Application of 10 mm glass thickness at 24 mm rebate depth possible (special latch on request)**

Complying to the current DIN EN 12209. Separately and successfully tested with 200,000 latch and 200,000 locking bolt operating cycles..

All locks with low noise whisper functionality. Plus adjustable handle follower +1,5°-1° (with the exception of „Non-locking latch, lever forward“).

## Sets (locks, hinges and sleeves)

Art. No.	Description	AL	AL	AL	AL
		anod Silver (150)	anod sim. Stainl-Steel satin (157)	anod Special (199)	p-coat Special color (399)
		€/Piece	€/Piece	€/Piece	€/Piece
<b>With follower for 8 mm glass thickness</b>					
	<b>10.050</b> Non-locking latch	147,00	211,00	265,00	251,00
	<b>10.051</b> Non-locking latch, lever forward	147,00	211,00	265,00	251,00
	<b>10.052</b> Prepared for profile cylinder	147,00	211,00	265,00	251,00
	<b>10.049</b> Prepared for round cylinder			296,00	282,00
	<b>10.053</b> Warded key	147,00	211,00	265,00	251,00
	<b>10.054</b> Toilet lock	197,00	274,00	321,00	305,00
	<b>10.034</b> Strike-box	155,00	223,00	277,00	264,00

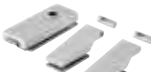
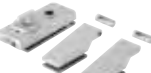





<b>With follower for 10 mm glass thickness</b>					
	<b>10.055</b> Non-locking latch	149,00	214,00	268,00	256,00
	<b>10.056</b> Non-locking latch, lever forward	149,00	214,00	268,00	256,00
	<b>10.057</b> Prepared for profile cylinder	149,00	214,00	268,00	256,00
	<b>10.060</b> Prepared for round cylinder	185,00	251,00	303,00	288,00
	<b>10.058</b> Warded key	149,00	214,00	268,00	256,00
	<b>10.059</b> Toilet lock	200,00	277,00	325,00	309,00
	<b>10.039</b> Strike-box	158,00	228,00	281,00	267,00

**Application of 10 mm glass thickness at 24 mm rebate depth possible (special latch on request)**

Complying to the current DIN EN 12209. Separately and successfully tested with 200,000 latch and 200,000 locking bolt operating cycles..

All locks with low noise whisper functionality. Plus adjustable handle follower +1,5°-1° (with the exception of „Non-locking latch, lever forward“).

## Sets (locks, hinges and sleeves) and single components

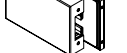

Art. No.	Description	AL anod Silver (150)	AL anod sim. Stainl- Steel satin (157)	AL p-coat Jet black (304)	AL anod Special (199)	AL p-coat Special color (399)
		€/Piece	€/Piece	€/Piece	€/Piece	€/Piece
<b>Single components</b>						
<b>Locks with follower for 8 – 10 mm glass thickness</b>						
	<b>10.001</b> Non-locking latch	102,00	145,00	145,00	185,00	176,00
	<b>10.002</b> Non-locking latch, lever forward	102,00	145,00	145,00	185,00	176,00
	<b>10.003</b> Prepared for profile cylinder	102,00	145,00	145,00	185,00	176,00
	<b>10.007</b> Prepared for round cylinder	136,00	178,00		219,00	209,00
	<b>10.004</b> Warded key	102,00	145,00	145,00	185,00	176,00
	<b>10.006</b> Toilet lock	157,00	213,00	213,00	242,00	231,00
	<b>10.005</b> Strike-box	111,00	156,00	156,00	200,00	188,00
	<b>10.512</b> Strike-box short	79,00	100,00		129,00	123,00

**Application of 10 mm glass thickness at 24 mm rebate  
depth possible (special latch on request)**

Complying to the current DIN EN 12209.  
Separately and successfully tested with 200,000 latch  
and 200,000 locking bolt operating cycles..

All locks with low noise whisper functionality.  
Plus adjustable handle follower +1,5°-1°  
(with the exception of „Non-locking latch, lever forward“).

## Single components

Art. No.	Description	AL anod Silver (150)	AL anod sim. Stain-Steel satin (157)	AL p-coat Jet black (304)	AL anod Special (199)	AL p-coat Special color (399)
		€/Piece	€/Piece	€/Piece	€/Piece	€/Piece
<b>Locks for levers with roses for 8 – 10 mm glass thickness</b>						
10.040	Non-locking latch	131,00	185,00		236,00	223,00
10.041	Non-locking latch, lever forward	131,00	185,00		236,00	223,00
10.042	Prepared for profile cylinder	131,00	185,00		236,00	223,00
10.044	Prepared for round cylinder				270,00	258,00
10.043	Warded key	131,00	185,00		236,00	223,00
<b>Door hinges for 8 mm glass thickness</b>						
	10.021 Classic, incl. sleeve	30,50	41,00	41,00	53,50	50,00
<b>Door hinges for 10 mm glass thickness</b>						
	10.020 Classic, incl. sleeve	31,50	42,00	42,00	55,50	52,50
<b>Frame parts</b>						
	10.424 Frame pivot for wooden frames/Studio	(000)	6,10			
Further frame parts on pages 162 – 163						

Glass door fittings single-action

**Application of 10 mm glass thickness at 24 mm rebate depth possible (special latch on request)**

Complying to the current DIN EN 12209. Separately and successfully tested with 200,000 latch and 200,000 locking bolt operating cycles..

All locks with low noise whisper functionality. Plus adjustable handle follower +1,5°/-1° (with the exception of „Non-locking latch, lever forward“).

# STUDIO Gala 2.0

Glass door fittings single-action



Technical data	
Glass	TSG
Glass thickness	8 mm (in frames with 24 mm rebate depth) 10 mm (in frames with 26 mm rebate depth; with special latch on request also in frames with 24 mm rebate depth)
max. door weight	45 to 60 kg (depending on the combination of STUDIO hinges and frame parts used) / upto 80 kg (depending on the combination of OFFICE hinges and frame parts used)
Lock application	non-locking latch, profile cylinder, warded key,
Applications	1-panel
Material	Aluminium
Finishes	Anodised- and RAL-Colors
Specials	Tested acc. DIN EN 12209, Lock insert with „low-noise-whisper“ functionality, Adjustable lever handle follower

## Manual single action door systems

### STUDIO

- 104 STUDIO Rondo
- 112 STUDIO Classic
- 118 STUDIO Gala 2.0
- 124 STUDIO Arcos
- 130 STUDIO1121
- 134 STUDIO Medio

### OFFICE

- 138 OFFICE Junior
- 144 OFFICE Classic
- 150 OFFICE Mundus
- 154 OFFICE Arcos

### 157 Special hinges

#### General accessories for the single action door range

- 162 Frame pivots for internal doors
- 164 Frame pockets, push-on sleeves, strike plates, door stop EASY Stop
- 166 Door rails for internal doors
- 169 Floor bearings, profile cylinders, door bolts, door catches, floor sockets

### Example view for STUDIO Gala 2.0

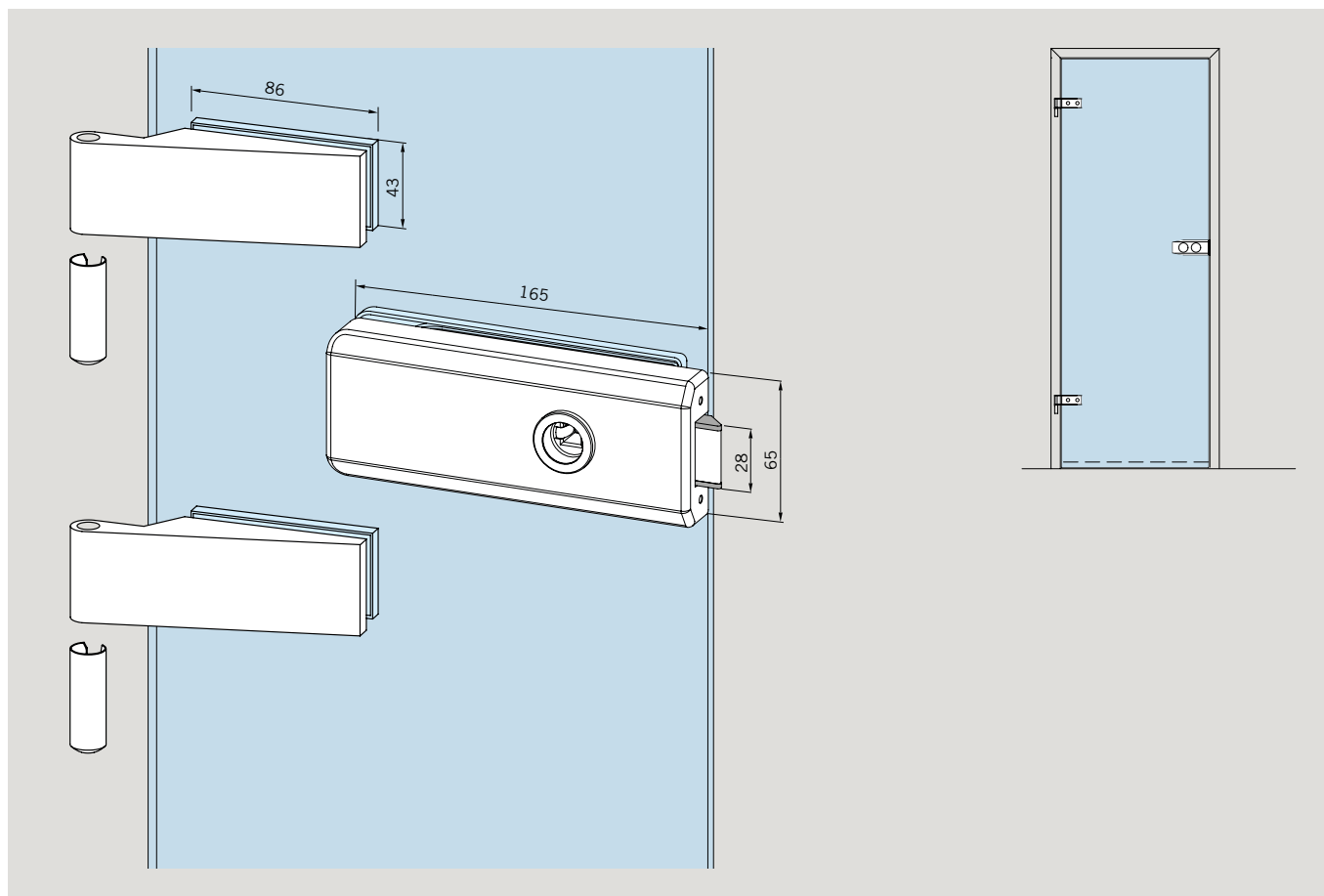

## Complete sets

Art. No.	Description	AL anod Silver (150)	AL anod sim. Stainl-Steel satin (157)	AL p-coat Jet black (304)
		€/Piece	€/Piece	€/Piece
	<b>With follower, for 8, 10 mm glass thickness (door weight 55 kg)</b>			
	<b>55.726</b> <b>Combination: STUDIO Gala 2.0 lock &amp; OFFICE Classic hinges</b> STUDIO Gala 2.0 lock non-locking latch, without lever, for lever forward, with follower for 8/10 mm glass thickness incl. 2 OFFICE Classic hinges and sleeves, 2 frame parts for wooden frames	175,00	234,00	234,00
	<b>55.727</b> <b>Combination: STUDIO Gala 2.0 lock &amp; OFFICE Classic hinges</b> STUDIO Gala 2.0 lock profile cylinder, without lever, with follower for 8/10 mm glass thickness incl. 2 OFFICE Classic hinges and sleeves, 2 frame parts for wooden frames	175,00	234,00	234,00
	<b>55.728</b> <b>Combination: STUDIO Gala 2.0 lock &amp; OFFICE Classic hinges</b> STUDIO Gala 2.0 lock warded key, without lever, with follower for 8/10 mm glass thickness incl. 2 OFFICE Classic hinges and sleeves, 2 frame parts for wooden frames	175,00	234,00	234,00









**Application of 10 mm glass thickness at 24 mm rebate  
depth possible (special latch on request)**

Complying to the current DIN EN 12209.  
Separately and successfully tested with 200,000 latch  
and 200,000 locking bolt operating cycles..

All locks with low noise whisper functionality.  
Plus adjustable handle follower +1,5°-1°  
(with the exception of „Non-locking latch, lever forward“).



## Sets (locks, hinges and sleeves)









Art. No.	Description	AL anod Silver (150)	AL anod sim. Stainl- Steel satin (157)	AL p-coat Special color (399)
		€/Piece	€/Piece	€/Piece
<b>STUDIO Gala 2.0 locks and OFFICE Classic hinges</b>				
	<b>19.630</b> STUDIO Gala 2.0 Non-locking latch, with OFFICE Classic Hinges	147,00	211,00	256,00
	<b>19.631</b> STUDIO Gala 2.0 non-locking latch, lever forward*, with OFFICE Classic Hinges	147,00	211,00	256,00
	<b>19.632</b> STUDIO Gala 2.0 prepared for profile cylinder, with OFFICE Classic Hinges	147,00	211,00	256,00
	<b>19.633</b> STUDIO Gala 2.0 warded key, with OFFICE Classic Hinges	147,00	211,00	256,00
<b>STUDIO Gala 2.0 locks and STUDIO Classic hinges</b>				
	<b>19.620</b> STUDIO Gala 2.0 Schloss Non-locking latch, with STUDIO Classic hinges	147,00	211,00	256,00
	<b>19.621</b> STUDIO Gala 2.0 non-locking latch, lever forward, with STUDIO Classic hinges	147,00	211,00	256,00
	<b>19.622</b> STUDIO Gala 2.0 prepared for profile cylinder, with STUDIO Classic hinges	147,00	211,00	256,00
	<b>19.623</b> STUDIO Gala 2.0 warded key, with STUDIO Classic hinges	147,00	211,00	256,00

**Application of 10 mm glass thickness at 24 mm rebate  
depth possible (special latch on request)**

Complying to the current DIN EN 12209.  
Separately and successfully tested with 200,000 latch  
and 200,000 locking bolt operating cycles..

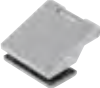
All locks with low noise whisper functionality.  
Plus adjustable handle follower +1,5°/-1°  
(with the exception of „Non-locking latch, lever forward“).

## Single components

Art. No.	Description	Base parts	AL	AL	AL	AL
		(000)	anod Silver (150)	anod sim. Stain-Steel satin (157)	p-coat Jet black (304)	p-coat Special color (399)
<b>Locks with follower</b>						
	<b>19.610</b> Non-locking latch		102,00	145,00		176,00
	<b>19.611</b> Non-locking latch, lever forward*		102,00	145,00	145,00	176,00
	<b>19.612</b> Prepared for profile cylinder		102,00	145,00	145,00	176,00
	<b>19.613</b> Warded key		102,00	145,00	145,00	176,00
<b>Door hinges</b>						
	<b>11.288</b> Aluminium door hinge with sleeve		31,00	40,50	40,50	51,00
	<b>10.021</b> Classic, with sleeve for 8 mm glass thickness		30,50	41,00	41,00	50,00
	<b>10.020</b> Classic, with sleeve, for 10 mm glass thickness		31,50	42,00		
<b>Frame pivots</b>						
	<b>11.310</b> Frame pivot for wooden frames / Office		6,20			
	<b>10.424</b> Frame pivot for wooden frames / STUDIO		6,20			

Further frame parts on pages 162 – 163

### Application of 10 mm glass thickness at 24 mm rebate depth possible (special latch on request)

Complying to the current DIN EN 12209.  
Separately and successfully tested with 200,000 latch and 200,000 locking bolt operating cycles..

All locks with low noise whisper functionality.  
Plus adjustable handle follower +1,5°-1°  
(with the exception of „Non-locking latch, lever forward“).

## Notes

# STUDIO Arcos



reddot design award



Technical data	
Glass	TSG
Glass thickness	8 mm (in frames with 24 mm rebate depth) 10 mm (in frames with 26 mm rebate depth; with special latch on request also in frames with 24 mm rebate depth)
max. door weight	45 to 60 kg (depending on the combination of STUDIO hinges and frame parts used) / upto 80 kg (depending on the combination of OFFICE hinges and frame parts used)
Lock application	non-locking latch, profile cylinder, warded key, toilet lock, round cylinder
Applications	1-/2 panels, sidelight
Material	Aluminium
Finishes	Anodised- and RAL-Colors (coated)
Specials	Tested acc. DIN EN 12209, Lock insert with „low-noise-whisper“ functionality, Adjustable lever handle follower (with the exception of „Non-locking latch, lever forward“)

## Manual single action door systems

### STUDIO

- 104 STUDIO Rondo
- 112 STUDIO Classic
- 118 STUDIO Gala 2.0
- 124 STUDIO Arcos
- 130 STUDIO1121
- 134 STUDIO Medio

### OFFICE

- 138 OFFICE Junior
- 144 OFFICE Classic
- 150 OFFICE Mundus
- 154 OFFICE Arcos

### 157 Special hinges

#### General accessories for the single action door range

- 162 Frame pivots for internal doors
- 164 Frame pockets, push-on sleeves, strike plates, door stop EASY Stop
- 166 Door rails for internal doors
- 169 Floor bearings, profile cylinders, door bolts, door catches, floor sockets

### Example view for STUDIO Arcos

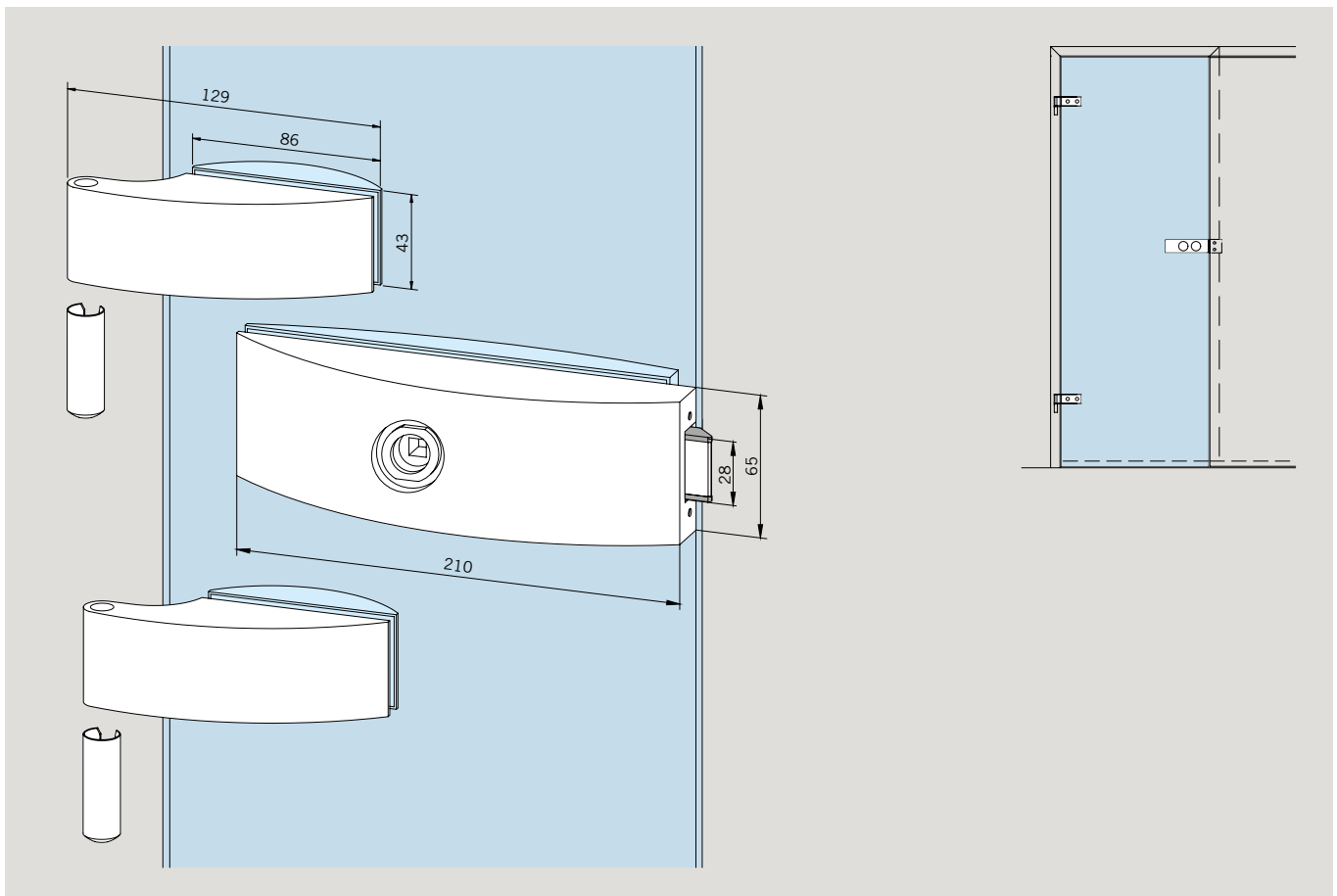

## Complete sets

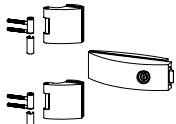
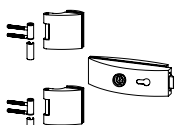
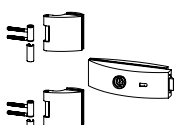





Art. No.	Description	AL anod EV1 Deco (114)	AL anod sim. Stainl- Steel satin (157)	AL p-coat Jet black (304)
		€/Piece	€/Piece	€/Piece
	<b>With follower, for 8, 10 mm glass thickness (door weight 55 kg)</b>			
	<b>51.718</b> <b>Combination: STUDIO Arcos &amp; OFFICE Arcos hinges</b> STUDIO Classic lock non-locking latch, without lever, lever forward, with follower for 8/10 mm glass thickness, incl. 2 OFFICE Arcos hinges and sleeves, 2 frame parts for wooden frames	<b>187,00</b>	<b>256,00</b>	<b>256,00</b>
	<b>51.719</b> <b>Combination: STUDIO Arcos &amp; OFFICE Arcos hinges</b> STUDIO Classic lock profile cylinder, without lever, with follower for 8/10 mm glass thickness, incl. 2 OFFICE Arcos hinges and sleeves, 2 frame parts for wooden frames	<b>187,00</b>	<b>256,00</b>	<b>256,00</b>
	<b>51.720</b> <b>Combination: STUDIO Arcos &amp; OFFICE Arcos hinges</b> STUDIO Classic lock warded key, without lever, with follower for 8/10 mm glass thickness, incl. 2 OFFICE Arcos hinges and sleeves, 2 frame parts for wooden frames	<b>187,00</b>	<b>256,00</b>	<b>256,00</b>

**Application of 10 mm glass thickness at 24 mm rebate  
depth possible (special latch on request)**

Complying to the current DIN EN 12209.  
Separately and successfully tested with 200,000 latch  
and 200,000 locking bolt operating cycles..

All locks with low noise whisper functionality.  
Plus adjustable handle follower +1,5°-1°  
(with the exception of „Non-locking latch, lever forward“).

## Complete sets (locks, hinges and sleeves)

Art. No.	Description	AL	AL	AL	AL
		anod EV1 Deco (114)	anod sim. Stain- Steel satin (157)	anod Special (199)	p-coat Special color (399)
		€/Piece	€/Piece	€/Piece	€/Piece
<b>With follower for 8 mm glass thickness</b>					
	<b>24.100</b> Non-locking latch	163,00	237,00	293,00	278,00
	<b>24.101</b> Non-locking latch, lever forward	163,00	237,00	293,00	278,00
	<b>24.102</b> Prepared for profile cylinder	163,00	237,00	293,00	278,00
	<b>24.108</b> Prepared for round cylinder			328,00	311,00
	<b>24.103</b> Warded key	163,00	237,00	293,00	278,00
	<b>24.106</b> Toilet lock	219,00	305,00	359,00	340,00







Glass door fittings single-action

### Application of 10 mm glass thickness at 24 mm rebate depth possible (special latch on request)

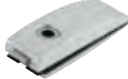
Complying to the current DIN EN 12209.  
Separately and successfully tested with 200,000 latch and 200,000 locking bolt operating cycles..

All locks with low noise whisper functionality.  
Plus adjustable handle follower +1,5°-1°  
(with the exception of „Non-locking latch, lever forward“).

## Single components

		AL anod EV1 Deco (114)	AL anod sim. Stain- Steel satin (157)	AL anod Special (199)	AL p-coat Special color (399)
Art. No.	Description	€/Piece	€/Piece	€/Piece	€/Piece
<b>Locks with follower for 8 – 10 mm glass thickness</b>					
	<b>24.200</b> Non-locking latch	116,00	159,00	205,00	196,00
	<b>24.201</b> Non-locking latch, lever forward	116,00	159,00	205,00	196,00
	<b>24.202</b> Prepared for profile cylinder	116,00	159,00	205,00	196,00
	<b>24.207</b> Prepared for round cylinder			239,00	228,00
	<b>24.203</b> Warded key	116,00	159,00	205,00	196,00
	<b>24.206</b> Toilet lock	176,00	239,00	270,00	258,00
	<b>24.220</b> Strike-box	100,00	141,00	182,00	174,00

Glass door fittings single-action





**Application of 10 mm glass thickness at 24 mm rebate depth possible (special latch on request)**

Complying to the current DIN EN 12209.  
Separately and successfully tested with 200,000 latch and 200,000 locking bolt operating cycles..

All locks with low noise whisper functionality.  
Plus adjustable handle follower +1,5°-1°  
(with the exception of „Non-locking latch, lever forward“).



## Single components

		Base parts (000)	AL anod EV1 Deco (114)	AL anod sim. Stain-Steel satin (157)	AL anod Special (199)	AL p-coat Special color (399)
Art. No.	Description	€/Piece	€/Piece	€/Piece	€/Piece	€/Piece
<b>Door hinges for 8 mm glass thickness</b>						
	<b>24.230</b> Arcos hinge, incl. sleeve	33,00	46,50	59,50	56,00	
	<b>25.451</b> Arcos hinge with frame pivot for non-rebated frames	61,50	84,00	104,00	99,50	
<b>Door hinges for 10 mm glass thickness</b>						
	<b>24.236</b> Arcos hinge, incl. sleeve	35,50	47,50	60,50	57,00	
	<b>24.420</b> Filling piece with screws to use with 24.230 for 28 – 40 mm rebate depth <b>(please indicate glass thickness and rebate depth)</b>	35,50	49,00	51,00	51,00	
<b>Frame parts</b>						
	<b>10.424</b> Frame pivot for wooden frames/STUDIO	6,10				
	<b>10.423</b> Frame pivot for steel frames/STUDIO	4,60				
	Further frame parts on pages 162 – 163					

Glass door fittings single-action

# STUDIO1121

Glass door fittings single-action



Technical data	
Glass	TSG
Glass thickness	8 mm (in frames with 24 mm rebate depth) 10 mm (in frames with 26 mm rebate depth; with special latch on request also in frames with 24 mm rebate depth)
max. door weight	45 to 60 kg (depending on the combination of STUDIO hinges and frame parts used) / upto 80 kg (depending on the combination of OFFICE hinges and frame parts used)
Lock application	non-locking latch, profile cylinder, toilet lock
Applications	1-/2 panels, sidelight
Material	Aluminium
Finishes	Anodised- and RAL-Colors (coated)

## Manual single action door systems

### STUDIO

104	STUDIO Rondo
112	STUDIO Classic
118	STUDIO Gala 2.0
124	STUDIO Arcos
130	STUDIO1121
134	STUDIO Medio

### OFFICE

138	OFFICE Junior
144	OFFICE Classic
150	OFFICE Mundus
154	OFFICE Arcos

### 157 Special hinges

#### General accessories for the single action door range

162	Frame pivots for internal doors
164	Frame pockets, push-on sleeves, strike plates, door stop EASY Stop
166	Door rails for internal doors
169	Floor bearings, profile cylinders, door bolts, door catches, floor sockets

### Example view for STUDIO Lock

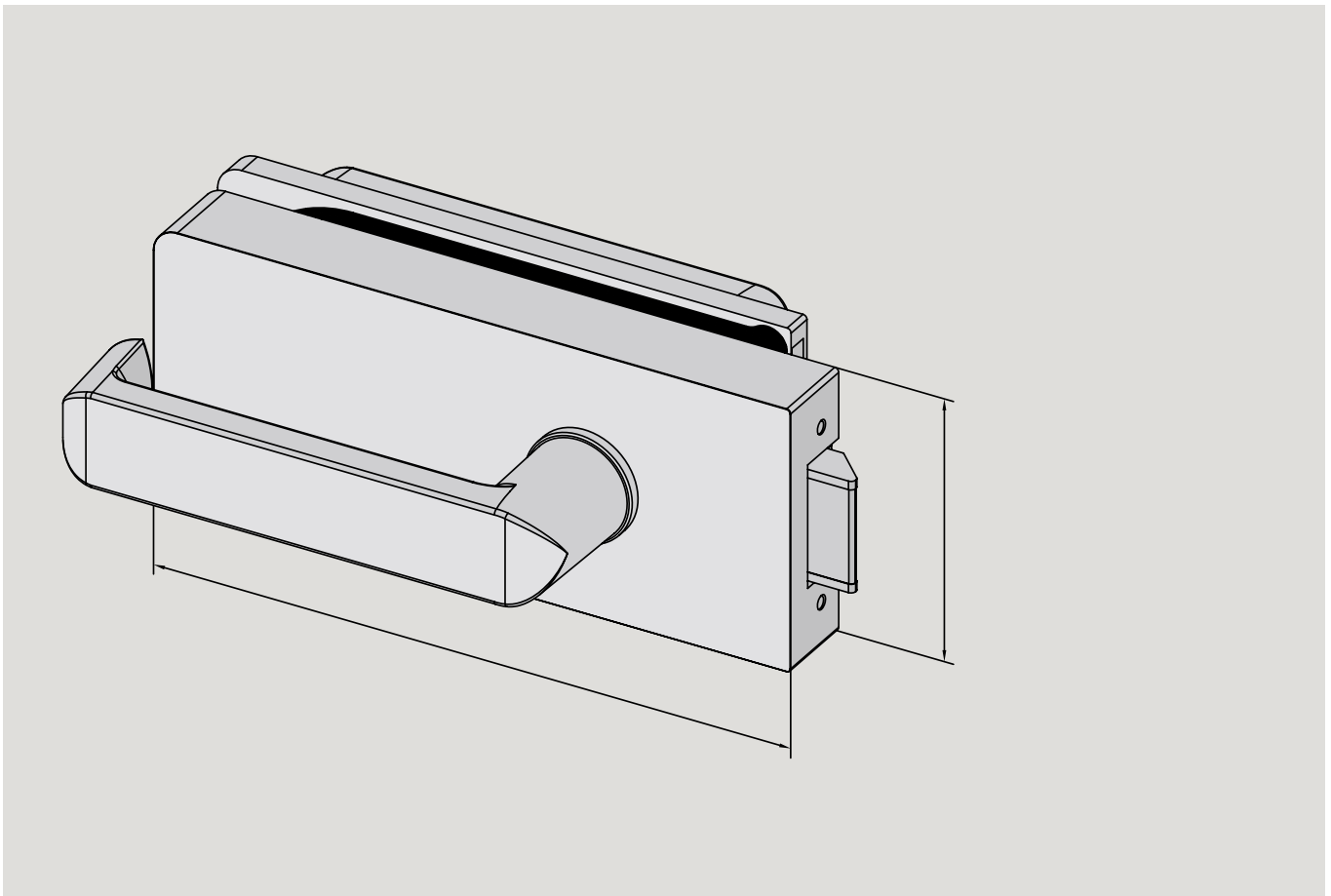

## Single components

Art. No.	Description	AL	AL	AL	AL	AL								
		anod Silver (150)	anod sim. Stain- Steel satin (157)	p-coat Jet black (304)	anod Special (199)	p-coat Special color (399)	€/Piece	€/Piece	€/Piece	€/Piece	€/Piece			
<b>Locks with follower</b>														
10.150	Non-locking latch	121,00	159,00	159,00	205,00	196,00								
10.149	Non-locking latch, lever front	121,00	159,00	159,00	205,00	196,00								
10.148	Prepared for profile cylinder, with change	121,00	159,00	159,00	205,00	196,00								
10.154	Toilet lock with bolt olive	185,00	239,00	239,00	270,00	258,00								
10.155	Strike-box	131,00	172,00	172,00	220,00	208,00								

## Notes

# STUDIO Medio

Glass door fittings single-action



Technical data	
Glass	TSG
Glass thickness	8, 10 mm
max. door weight	45 to 60 kg (depending on the combination of STUDIO hinges and frame parts used) / upto 80 kg (depending on the combination of OFFICE hinges and frame parts used)
Lock application	non-locking latch
Applications	1-/2 panels, sidelight
Material	Aluminium
Finishes	Anodised- and RAL-Colors (coated)
Specials	minimal measures

## Manual single action door systems

### STUDIO

- 104 STUDIO Rondo
- 112 STUDIO Classic
- 118 STUDIO Gala 2.0
- 124 STUDIO Arcos
- 130 STUDIO1121
- 134 STUDIO Medio

### OFFICE

- 138 OFFICE Junior
- 144 OFFICE Classic
- 150 OFFICE Mundus
- 154 OFFICE Arcos

### 157 Special hinges

#### General accessories for the single action door range

- 162 Frame pivots for internal doors
- 164 Frame pockets, push-on sleeves, strike plates, door stop EASY Stop
- 166 Door rails for internal doors
- 169 Floor bearings, profile cylinders, door bolts, door catches, floor sockets

### Example view for STUDIO Medio

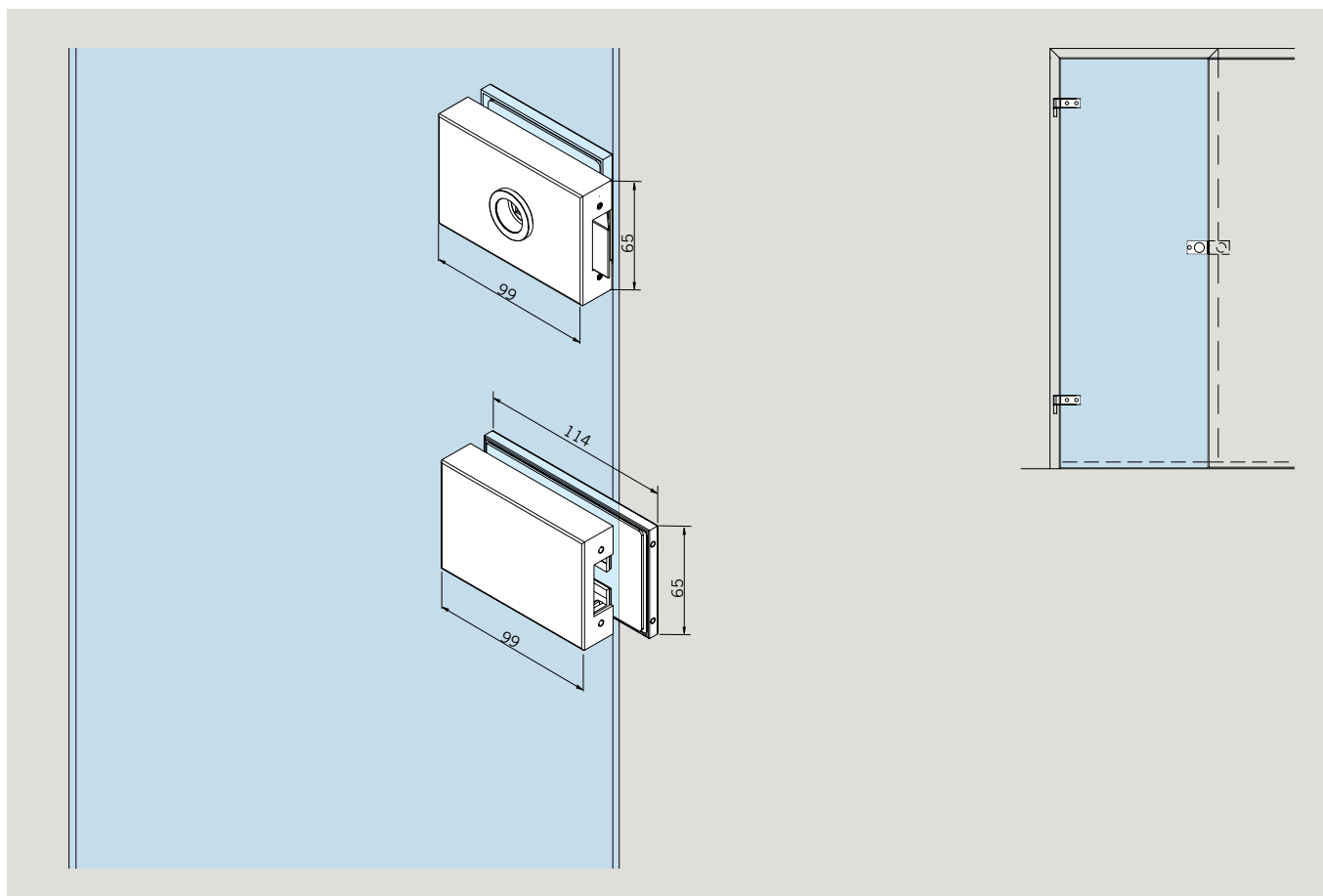

## Complete sets and single components

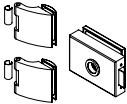
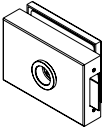
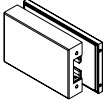
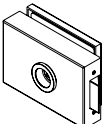
			AL anod Silver (150)	AL anod sim. Stain- Steel satin (157)	AL p-coat Jet black (304)	AL anod Special (199)	AL p-coat Special color (399)
	Art. No.	Description	€/Piece	€/Piece	€/Piece	€/Piece	€/Piece
	<b>10.511</b>	<b>Combination: STUDIO Medio lock &amp; OFFICE Arcos hinges</b> STUDIO Medio lock non-locking latch, without lever, for lever forward, with follower for 8 mm Glass thickness, incl. 2 OFFICE Arcos hinges and sleeves		<b>163,00</b>	<b>163,00</b>		
		<b>Single components</b>					
		<b>STUDIO Medio lock with follower for 8 mm glass thickness</b>					
	<b>10.510</b>	Non-locking latch	<b>78,00</b>	<b>89,00</b>		<b>114,00</b>	<b>108,00</b>
	<b>10.512</b>	Strike-box	<b>79,00</b>	<b>100,00</b>		<b>129,00</b>	<b>123,00</b>
		<b>STUDIO Medio lock with follower for 10 mm glass thickness (in door frame with 24 mm rebate depth)</b>					
	<b>10.509</b>	Non-locking, milled latch	<b>79,00</b>	<b>91,00</b>			<b>109,00</b>

Glass door fittings single-action



## Notes

# OFFICE Junior

Glass door fittings single-action



Technical data	
Glass	TSG
Glass thickness	8, 10 , 12 mm (please indicate with your order)
max. door weight	55 to 80 kg (depending on the combination of OFFICE hinges and frame parts used)
Lock application	non-locking latch, profile cylinder, warded key, toilet lock, round cylinder
Applications	1-/2 panels, sidelight
Material	Aluminium, stainless steel
Finishes	Anodised- and RAL-Colors (coated), stainless steel
Specials	Tested acc. DIN EN 12209, Save for intense operational demands, Lock insert with „low-noise-whisper“ functionality, Adjustable lever handle follower

## Manual single action door systems

### STUDIO

- 104 STUDIO Rondo
- 112 STUDIO Classic
- 118 STUDIO Gala 2.0
- 124 STUDIO Arcos
- 130 STUDIO1121
- 134 STUDIO Medio

### OFFICE

- 138 OFFICE Junior
- 144 OFFICE Classic
- 150 OFFICE Mundus
- 154 OFFICE Arcos

### 157 Special hinges



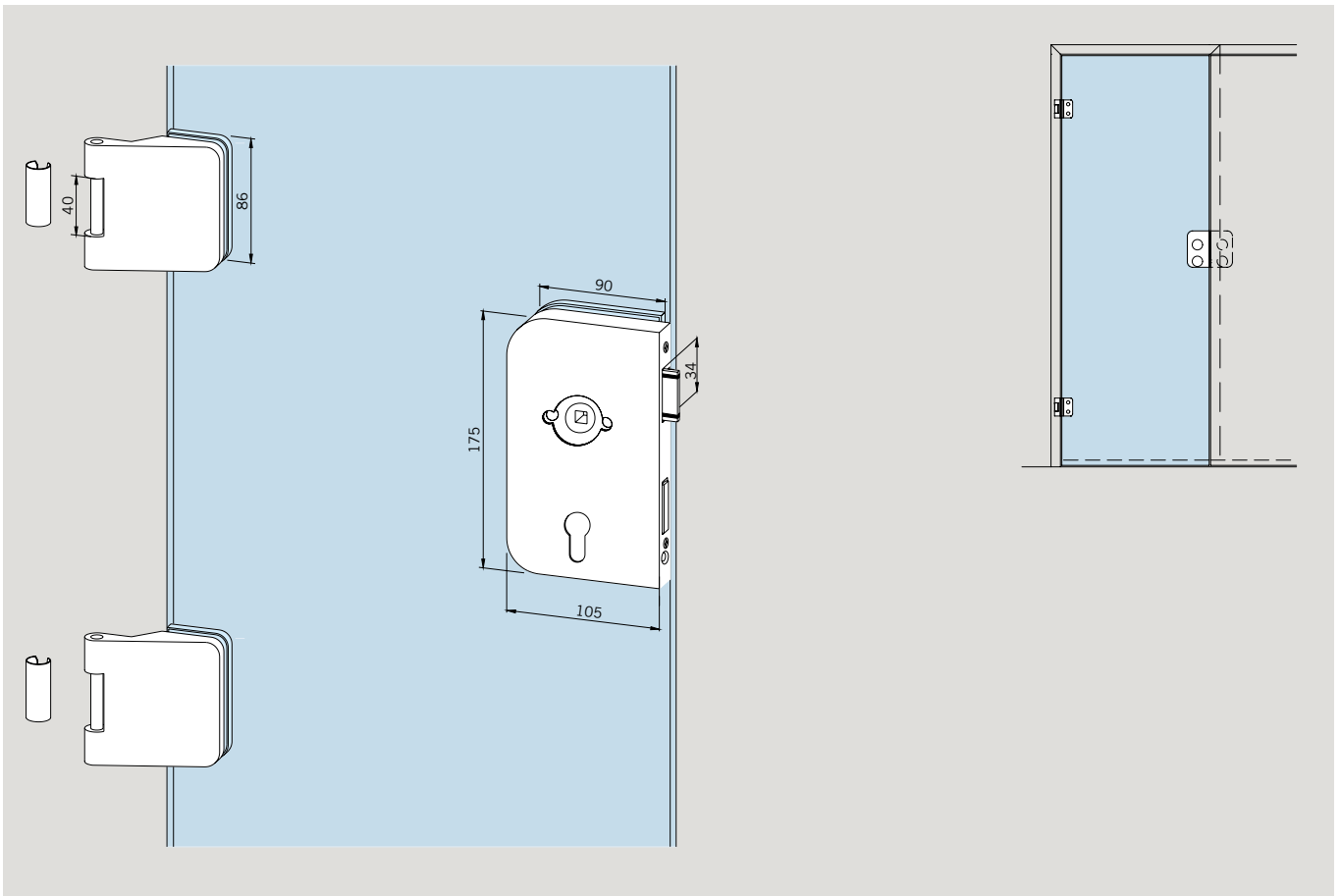

#### General accessories for the single action door range

- 162 Frame pivots for internal doors
- 164 Frame pockets, push-on sleeves, strike plates, door stop EASY Stop
- 166 Door rails for internal doors
- 169 Floor bearings, profile cylinders, door bolts, door catches, floor sockets

#### Example view for OFFICE Junior

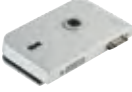
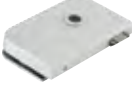







## Single components

Art. No.	Description	DIN	AL anod Silver (150) €/Piece	AL anod sim. Stainl-Steel satin (157) €/Piece	AL p-coat Jet black (304) €/Piece	Stainl-Steel satin (700) €/Piece	AL anod Special (199) €/Piece	AL p-coat Special color (399) €/Piece
<b>Locks with follower for 8 – 12 mm glass thickness</b>								
	<b>11.260</b> Prepared for profile cylinder, public building type	LH	121,00	153,00	153,00	226,00	219,00	209,00
	<b>11.261</b> do.	RH	121,00	153,00	153,00	226,00	219,00	209,00
	<b>11.262</b> Warded key	LH	96,00	130,00	130,00	201,00	172,00	162,00
	<b>11.263</b> do.	RH	96,00	130,00	130,00	201,00	172,00	162,00
	<b>11.264</b> Non-locking latch	LH	96,00	130,00	130,00	201,00	172,00	162,00
	<b>11.265</b> do.	RH	96,00	130,00	130,00	201,00	172,00	162,00
	<b>11.266</b> Prepared for round cylinder	LH	121,00	219,00			219,00	209,00
	<b>11.267</b> do.	RH	121,00	219,00			219,00	209,00
	<b>11.206</b> Strike-box	LH	102,00	149,00	149,00	201,00	173,00	163,00
	<b>11.207</b> do.	RH	102,00	149,00	149,00	201,00	173,00	163,00
<b>Locks for levers with roses for 8 – 12 mm glass thickness</b>								
	<b>11.200</b> Prep. for profile cylinder, public building type	LH	121,00	153,00	153,00	226,00	219,00	209,00
	<b>11.201</b> do.	RH	121,00	153,00	153,00	226,00	219,00	209,00
	<b>11.210</b> Prepared for cylinder, lock corrosion resistant	LH	268,00	303,00			413,00	392,00
	<b>11.211</b> do.	RH	268,00	303,00			413,00	392,00









Complying to the current DIN EN 12209 – applicable in public buildings. Separately and successfully tested with 500,000 latch and 100,000 locking bolt operating cycles..

All locks with low noise whisper functionality and adjustable handle follower +1,5%–1°.

## Single components

Art. No.	Description	DIN	AL	AL	AL	Stainl-	AL	AL
			anod Silver (150)	anod sim. Stainl- Steel satin (157)	p-coat Jet black (304)	Steel satin (700)	anod Special (199)	p-coat Special color (399)
			€/Piece	€/Piece	€/Piece	€/Piece	€/Piece	€/Piece
<b>Locks for levers with roses for 8 – 12 mm glass thickness</b>								
	<b>11.212</b> Non-locking latch public building type	LH	121,00	153,00		226,00	219,00	209,00
	<b>11.213</b> do.	RH	121,00	153,00		226,00	219,00	209,00
	<b>11.202</b> Warded key	LH	96,00	130,00	130,00	201,00	172,00	162,00
	<b>11.203</b> do.	RH	96,00	130,00	130,00	201,00	172,00	162,00
	<b>11.204</b> Toilet lock	LH	145,00	196,00	196,00		259,00	245,00
	<b>11.205</b> do.	RH	145,00	196,00	196,00		259,00	245,00
	<b>11.214</b> Toilet lock lock corrosion resistant	LH	287,00	340,00			453,00	431,00
	<b>11.215</b> do.	RH	287,00	340,00			453,00	431,00
	<b>11.240</b> Prepared for round cylinder	LH	121,00	219,00			219,00	209,00
	<b>11.241</b> do.	RH	121,00	219,00			219,00	209,00
	<b>11.228</b> OFFICE Classic lock, prepared for profile cylinder, with cylinder roses on both sides, public building type	LH	163,00	199,00			268,00	256,00
	<b>11.229</b> do.	RH	163,00	199,00			268,00	256,00
	<b>11.242</b> Prepared for profile cylinder, with cylinder roses on one side, public building type	LH	141,00	180,00			241,00	230,00
	<b>11.243</b> do.	RH	141,00	180,00			241,00	230,00
	<b>11.206</b> Strike-box	LH	102,00	149,00	149,00	201,00	173,00	163,00
	<b>11.207</b> do.	RH	102,00	149,00	149,00	201,00	173,00	163,00

## Single components

Art. No.	Description	AL anod Silver (150)	AL anod sim. Stainl-Steel satin (157)	AL p-coat Jet black (304)	Stainl-Steel satin (700)	AL anod Special (199)	AL p-coat Special color (399)
		€/Piece	€/Piece	€/Piece	€/Piece	€/Piece	€/Piece
<b>Door hinges with frame part</b>							
<b>Door hinges 8 – 10 mm (12 mm on request)</b>							
	<b>11.233</b> Aluminium door hinge for heavy doors, plastic slide bearing, stainless steel bolt and frame pivot for 160 mm frame pocket	81,00	91,00			123,00	118,00
	<b>11.340</b> do. for 40 mm rebate depth,	111,00	119,00			153,00	146,00
<b>Door hinges</b>							
	<b>11.230</b> Aluminium door hinge with sleeve (in finish 700 not usable with screw on frame pivots 11.405)	31,00	40,50	40,50	74,50	54,00	51,00
	<b>11.237</b> Aluminium door hinge with sleeve, stainless steel pin, for 24 mm rebate depth	33,50	41,50			57,00	55,00
	<b>11.238</b> Aluminium door hinge with sleeve for 40 mm rebate depth	45,00	57,00	57,00		82,00	78,00
	<b>11.245</b> Aluminium door hinge with sleeve, for 25 – 39 mm rebate depth	61,00	74,50			98,00	92,50
	<b>11.500</b> Stainless steel hinge for internal doors				62,50		
	<b>11.502</b> Stainless steel hinge for internal doors, for 40 mm rebate depth				66,00		
	<b>11.239</b> Aluminium door hinge with frame pivot for wooden frames	56,00	76,50			94,00	90,50
	<b>12.090</b> Aluminium door hinge with frame pivot for non-rebated frames	56,00	76,50	76,50		95,00	90,50
<b>Frame parts</b>							
	<b>11.310</b> Frame pivot for wooden frames/OFFICE	Base parts 6,20					
	<b>11.309</b> Frame pivot for steel frames/OFFICE	Base parts 4,60					
Further frame parts on pages 162 – 163							

## Notes

# OFFICE Classic

Glass door fittings single-action



Technical data	
Glass	TSG
Glass thickness	8, 10, 12 mm (please indicate with the order)
max. door weight	55 to 80 kg (depending on the combination of OFFICE hinges and frame parts used)
Lock application	non-locking latch, profile cylinder, warded key, toilet lock, round cylinder
Applications	1-/2 panels, sidelight
Material	Aluminium
Finishes	Anodised- and RAL-Colors (coated)
Specials	Tested acc. DIN EN 12209, Save for intense operational demands, Lock insert with „low-noise-whisper“ functionality, Adjustable lever handle follower



## Manual single action door systems

### STUDIO

- 104 STUDIO Rondo
- 112 STUDIO Classic
- 118 STUDIO Gala 2.0
- 124 STUDIO Arcos
- 130 STUDIO1121
- 134 STUDIO Medio

### OFFICE

- 138 OFFICE Junior
- 144 OFFICE Classic
- 150 OFFICE Mundus
- 154 OFFICE Arcos

### 157 Special hinges



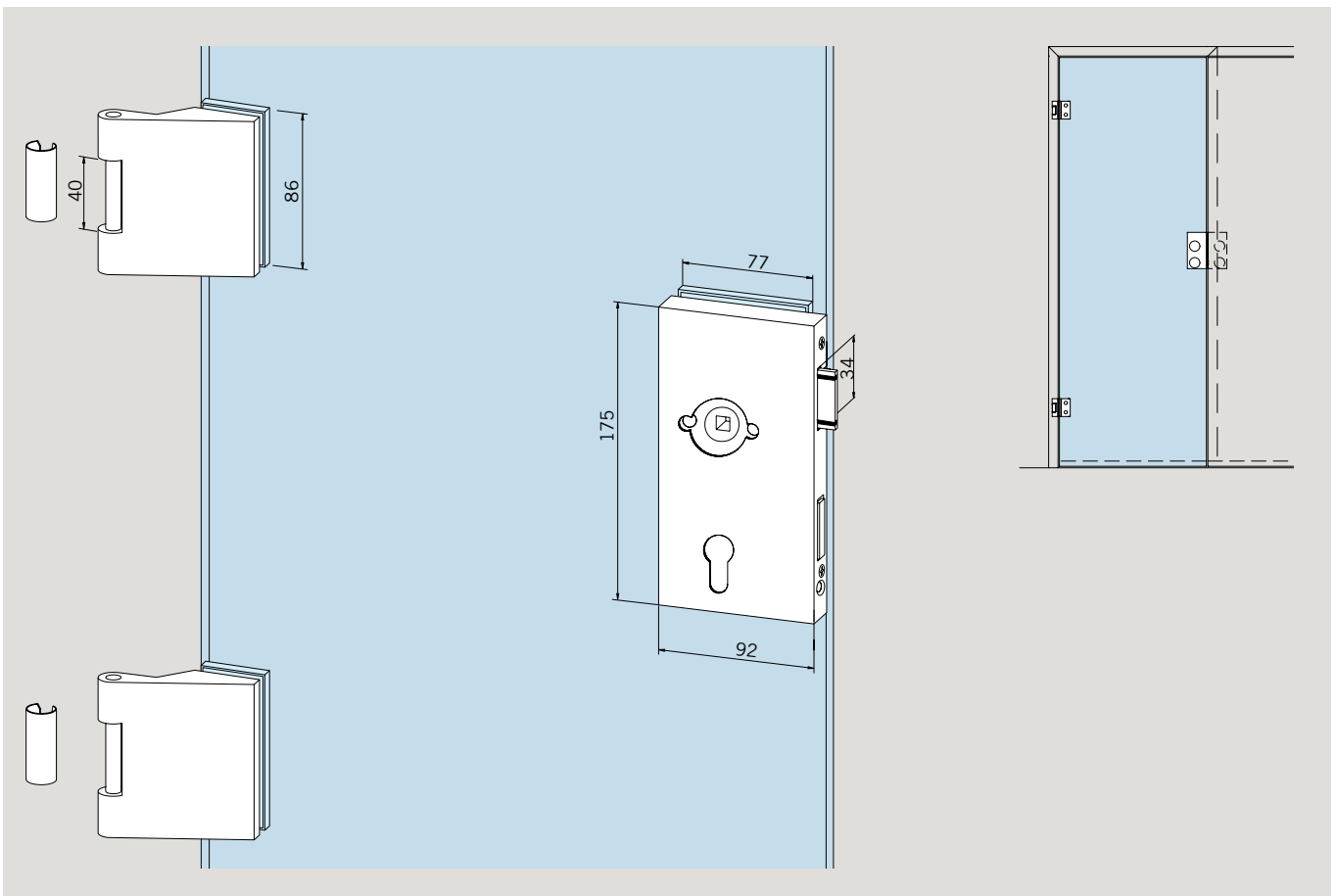

#### General accessories for the single action door range

- 162 Frame pivots for internal doors
- 164 Frame pockets, push-on sleeves, strike plates, door stop EASY Stop
- 166 Door rails for internal doors
- 169 Floor bearings, profile cylinders, door bolts, door catches, floor sockets

### Example view for OFFICE Classic









## Single components

Art. No.	Description	DIN	AL	AL	AL	AL	AL
			anod Silver (150)	anod sim. Stainl-Steel satin (157)	p-coat Jet black (304)	anod Special (199)	p-coat Special color (399)
			€/Piece	€/Piece	€/Piece	€/Piece	€/Piece
<b>Locks with follower for 8 – 12 mm glass</b>							
	<b>11.280</b> Prepared for profile cylinder, public building type	LH	121,00	153,00	153,00	219,00	209,00
	<b>11.281</b> do.	RH	121,00	153,00	153,00	219,00	209,00
	<b>11.282</b> Warded key	LH	96,00	130,00	130,00	172,00	162,00
	<b>11.283</b> do.	RH	96,00	130,00	130,00	172,00	162,00
	<b>11.284</b> Non-locking latch	LH	96,00	130,00	130,00	172,00	162,00
	<b>11.285</b> do.	RH	96,00	130,00	130,00	172,00	162,00
	<b>11.320</b> Prepared for round cylinder	LH	121,00	219,00		219,00	209,00
	<b>11.321</b> do.	RH	121,00	219,00		219,00	209,00
	<b>11.286</b> Strike-box	LH	102,00	149,00	149,00	172,00	162,00
	<b>11.287</b> do.	RH	102,00	149,00	149,00	172,00	162,00

Complying to the current DIN EN 12209 – applicable in public buildings.  
Separately and successfully tested with 500,000 latch and 100,000 locking bolt operating cycles..

All locks with low noise whisper functionality and adjustable handle follower +1,5%–1°.











## Single components

Art. No.	Description	DIN	AL	AL	AL	AL	AL		
			anod Silver (150)	anod sim. Stainl- Steel satin (157)	p-coat Jet black (304)	anod Special (199)	p-coat Special color (399)	€/Piece	€/Piece
<b>Locks for levers with roses for 8 – 12 mm glass</b>									
	<b>11.270</b> Prepared for profile cylinder, public building type	LH	121,00	153,00	153,00	219,00	209,00		
	<b>11.271</b> do.	RH	121,00	153,00	153,00	219,00	209,00		
	<b>11.272</b> Warded key	LH	96,00	130,00	130,00	172,00	162,00		
	<b>11.273</b> do.	RH	96,00	130,00	130,00	172,00	162,00		
	<b>11.274</b> Non-locking latch	LH	96,00	130,00	130,00	172,00	162,00		
	<b>11.275</b> do.	RH	96,00	130,00	130,00	172,00	162,00		
	<b>11.276</b> Toilet lock	LH	145,00	196,00	196,00	259,00	245,00		
	<b>11.277</b> do.	RH	145,00	196,00	196,00	259,00	245,00		
	<b>11.278</b> Prepared for round cylinder	LH	121,00	219,00		219,00	209,00		
	<b>11.279</b> do.	RH	121,00	219,00		219,00	209,00		
	<b>11.286</b> Strike-box	LH	102,00	149,00	149,00	172,00	162,00		
	<b>11.287</b> do.	RH	102,00	149,00	149,00	172,00	162,00		

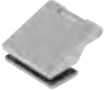
Complying to the current DIN EN 12209 – applicable in public buildings. Separately and successfully tested with 500,000 latch and 100,000 locking bolt operating cycles..

All locks with low noise whisper functionality and adjustable handle follower +1,5%/-1°.

## Single components

Art. No.	Description	AL anod Silver (150)	AL anod sim. Stainl-Steel satin (157)	AL p-coat Jet black (304)	Stainl-Steel satin (700)	AL anod Special (199)	AL p-coat Special color (399)
		€/Piece	€/Piece	€/Piece	€/Piece	€/Piece	€/Piece
<b>Door hinges with frame part 8 – 10 mm (12 mm on request)</b>							
	<b>11.291</b> Aluminium door hinge for heavy doors, plastic slide bearing and frame pivot for 160 mm frame pocket	78,00	86,00			120,00	113,00
	<b>11.341</b> do. for 40 mm rebate depth,	111,00	119,00			153,00	146,00
	<b>11.342</b> OFFICE Classic door hinge with frame pivot for wooden frames	56,00	76,50			94,00	90,50
	<b>12.091</b> Aluminium door hinge with frame pivot for non-rebated frames	56,00	76,50	76,50		95,00	90,50
<b>Door hinges 24 mm rebate depth</b>							
	<b>11.288</b> Aluminium door hinge with sleeve	31,00	40,50	40,50		54,00	51,00
	<b>11.500</b> Stainless steel hinge for internal doors					62,50	
<b>Door hinges 25 – 39 mm rebate depth</b>							
	<b>11.297</b> Aluminium door hinge with sleeve, for 25 - 39 mm rebate depth	61,00	74,50			98,00	93,00
<b>Door hinges 40 mm rebate depth</b>							
	<b>11.295</b> Aluminium door hinge with sleeve, for 40 mm rebate depth	45,00	57,00			76,50	72,50
	<b>11.502</b> Stainless steel hinge for internal doors, for 40 mm rebate depth					66,00	
<b>Frame pivots</b>							
	<b>11.310</b> Frame pivot for wooden frames/Office	Base parts		6,20			
	<b>11.309</b> Frame pivot for steel frames/Office	Base parts		4,60			
Further frame parts on pages 162 – 163							

## Notes

# OFFICE Mundus

Glass door fittings single-action



Technical data	
Glass	TSG
Glass thickness	8 and 10 mm (other glass thicknesses can be realized with separately available accessories)
max. door weight	55 to 80 kg (depending on the combination of OFFICE hinges and frame parts used)
Lock application	Non-locking latch, profile cylinder
Applications	1 / 2 panels, sidelight
Material	Aluminium, stainless steel
Finishes	Anodised- and RAL-Colors (coated), stainless steel
Specials	Tested acc. DIN EN 12209, Save for intense operational demands, Lock insert with „low-noise-whisper“ functionality, Adjustable lever handle follower

## Manual single action door systems

### STUDIO

104	STUDIO Rondo
112	STUDIO Classic
118	STUDIO Gala 2.0
124	STUDIO Arcos
130	STUDIO1121
134	STUDIO Medio

### OFFICE

138	OFFICE Junior
144	OFFICE Classic
150	OFFICE Mundus
154	OFFICE Arcos

### 157 Special hinges

#### General accessories for the single action door range

162	Frame pivots for internal doors
164	Frame pockets, push-on sleeves, strike plates, door stop EASY Stop
166	Door rails for internal doors
169	Floor bearings, profile cylinders, door bolts, door catches, floor sockets

### Example view for OFFICE Mundus

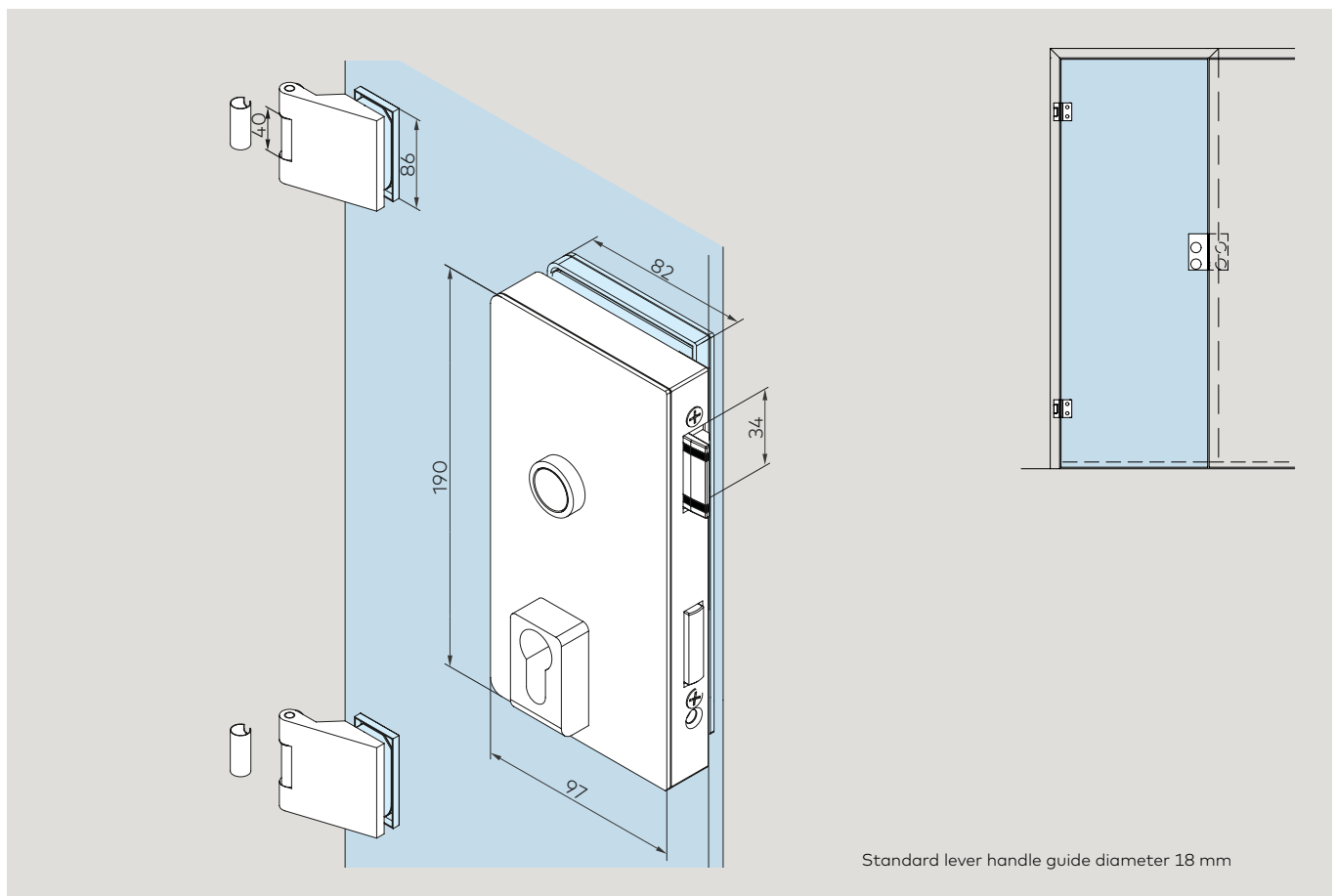

## Single components

Art. No.	Description	DIN	AL anod Silver (150)	AL anod sim. Stain- Steel satin (157)	AL p-coat Jet black (304)	Stain- Steel satin (750)	Stain- Steel polished (751)	AL anod Special (199)	AL p-coat Special color (399)	
<b>Locks with follower for 8-10 mm glass thickness</b>										
	<b>11.838</b> Prepared for Euro profile cylinder	LH	157,00	182,00	182,00	242,00	256,00	256,00	242,00	
	<b>11.839</b> do.	RH	157,00	182,00	182,00	242,00	256,00	256,00	242,00	
	<b>11.840</b> Non-locking latch	LH	132,00	157,00	157,00	218,00	231,00	231,00	219,00	
	<b>11.841</b> do.	RH	132,00	157,00	157,00	218,00	231,00	231,00	219,00	
<b>11.860</b>	<b>Pair lever-follower ring for levers with follower diameter 16 mm</b> for locks 11.838 / 11.839 / 11.840 / 11.841		(000) 30,50							
<b>Locks for levers with roses for 8-10 mm glass thickness</b>										
	<b>11.842</b> Prepared for Euro profile cylinder	LH	157,00	182,00	182,00	242,00	256,00	256,00	242,00	
	<b>11.843</b> do.	RH	157,00	182,00	182,00	242,00	256,00	219,00	242,00	
	<b>11.844</b> Non-locking latch	LH	132,00	157,00	157,00	218,00	231,00	231,00	219,00	
	<b>11.845</b> do.	RH	132,00	157,00	157,00	218,00	231,00	231,00	219,00	

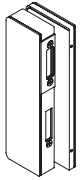

## Single components

Art. No.	Description	DIN	AL	AL	AL	Stainl-	Stainl-	AL	AL
			anod Silver (150)	anod sim. Stainl- Steel satin (157)	p-coat Jet black (304)	Steel satin (750)	Steel polished (751)	anod Special (199)	p-coat Special color (399)
			€/Piece	€/Piece	€/Piece	€/Piece	€/Piece	€/Piece	€/Piece
	<b>11.848</b> Strike boxes for 8-10 mm glass thickness for locks 11.839 / 11.841 / 11.843 / 11.845	LH	132,00	171,00	171,00	231,00	242,00	242,00	231,00
	<b>11.849</b> Strike boxes for 8-10 mm glass thickness for locks 11.838 / 11.840 / 11.842 / 11.844	RH	132,00	171,00	171,00	231,00	242,00	242,00	231,00
<b>Screw sets for thicker glasses</b>									
<b>11.861</b>	<b>OFFICE Mundus screw set to assemble lock</b> on glass with thickness 12 - 15 mm		(000) 4,30						
<b>11.862</b>	<b>OFFICE Mundus screw set to assemble lock</b> on glass with thickness 15 - 22 mm		(000) 4,30						
<b>11.863</b>	<b>OFFICE Mundus screw set to assemble strike box</b> on glass with thickness 12 - 15 mm		(000) 4,30						
<b>11.864</b>	<b>OFFICE Mundus screw set to assemble strike box</b> on glass with thickness 15 - 19 mm		(000) 4,30						
<b>11.865</b>	<b>OFFICE Mundus screw set to assemble strike box</b> on glass with thickness 19 - 22 mm		(000) 4,30						

# OFFICE Arcos

Glass door fittings single-action



Technical data	
Glass	TSG
Glass thickness	8, 10, 12 mm (please indicate with the order)
max. door weight	55 to 80 kg (depending on the combination of OFFICE hinges and frame parts used)
Lock application	non-locking latch, profile cylinder, warded key, round cylinder
Applications	1-/2 panels, sidelight
Material	Aluminium
Finishes	Anodised- and RAL-Colors (coated)
Specials	Tested acc. DIN EN 12209, Save for intense operational demands, Lock insert with „low-noise-whisper“ functionality, Adjustable lever handle follower

## Manual single action door systems

### STUDIO

- 104 STUDIO Rondo
- 112 STUDIO Classic
- 118 STUDIO Gala 2.0
- 124 STUDIO Arcos
- 130 STUDIO1121
- 134 STUDIO Medio

### OFFICE

- 138 OFFICE Junior
- 144 OFFICE Classic
- 150 OFFICE Mundus
- 154 OFFICE Arcos

### 157 Special hinges



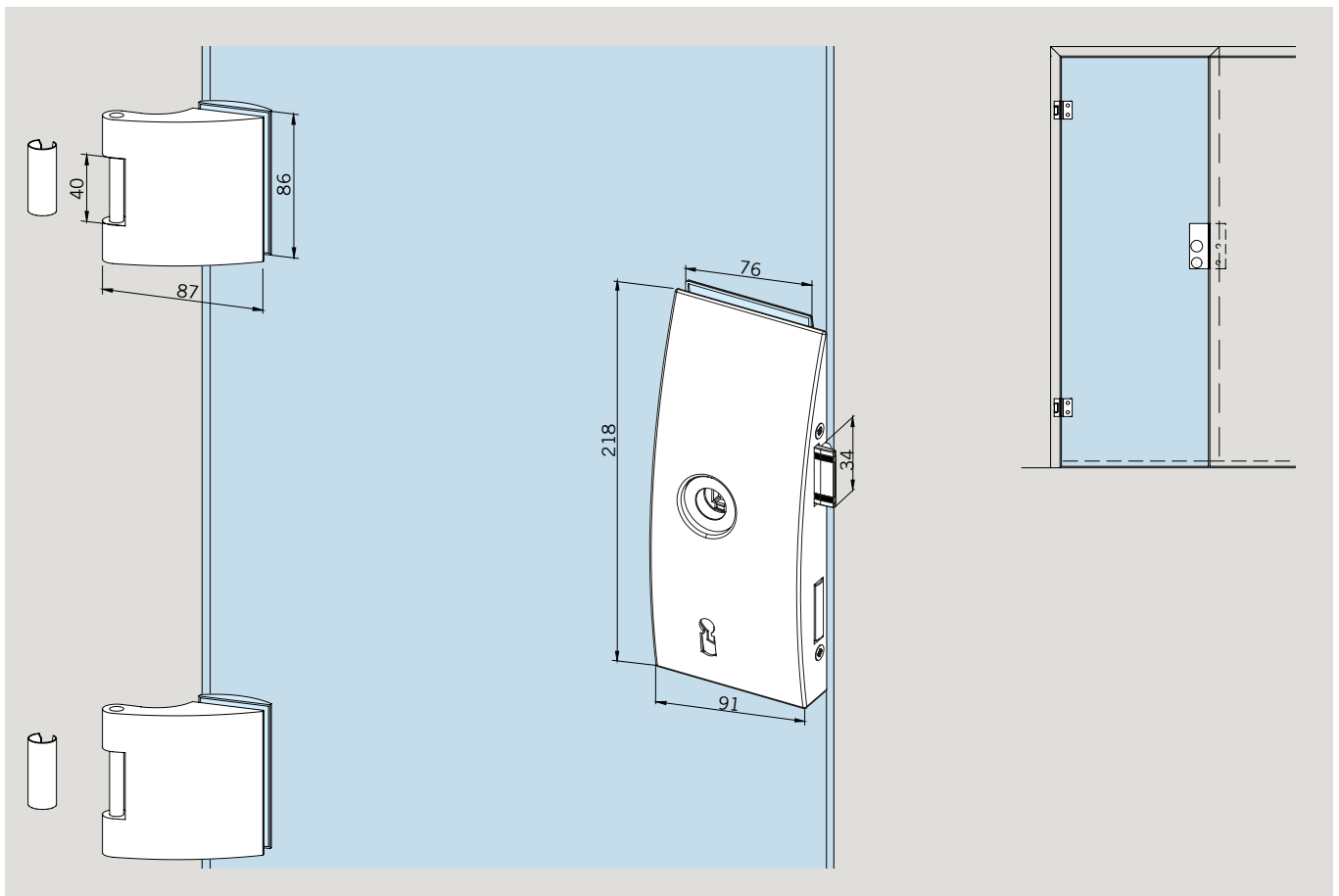

#### General accessories for the single action door range

- 162 Frame pivots for internal doors
- 164 Frame pockets, push-on sleeves, strike plates, door stop EASY Stop
- 166 Door rails for internal doors
- 169 Floor bearings, profile cylinders, door bolts, door catches, floor sockets

### Example view for OFFICE Arcos

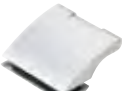

## Single components

Art. No.	Description	DIN	AL anod EV1 Deco (114)	AL anod sim. Stainl- Steel satin (157)	AL anod Special (199)	AL p-coat Special color (399)
			€/Piece	€/Piece	€/Piece	€/Piece
<b>Locks with follower for 8 – 10 mm glass thickness</b>						
	<b>25.260</b> Prepared for profile cylinder, with nightlatch function	LH	129,00	163,00	232,00	221,00
	<b>25.261</b> do.	RH	129,00	163,00	232,00	221,00
	<b>25.264</b> Non-locking-latch	LH	102,00	139,00	184,00	175,00
	<b>25.265</b> do.	RH	102,00	139,00	184,00	175,00
	<b>25.206</b> Strike-box	LH	120,00	157,00	190,00	181,00
	<b>25.207</b> do.	RH	120,00	157,00	190,00	181,00
<b>Door hinges 8 – 10 mm</b>						
	<b>25.230</b> Aluminium door hinge with sleeve		31,00	41,50	57,00	55,00
	<b>25.238</b> do. for 40 mm rebate depth		49,00	62,50	89,00	84,00
<b>Frame parts</b>						
	<b>11.310</b> Frame pivot for wooden frames/Office		Base parts 6,20			
	<b>11.309</b> Frame pivot for steel frames/Office		Base parts 4,60			

Further frame parts on pages 162 – 163

Complying to the current DIN EN 12209 – applicable in public buildings.  
Separately and successfully tested with 500,000 latch and 100,000 locking bolt operating cycles..

All locks with low noise whisper functionality and adjustable handle follower +1,5°–1°.

## Notes

# Special hinges



Technical data	
Glass	TSG
Glass thickness	8, 10 mm
max. door weight	depending on the hinge type
Applications	1/2-panels, sidelight
Material	Aluminium, stainless steel
Finishes	Anodised- and RAL-Colors (coated)
Specials	Tested acc. DIN 1670

## Manual single action door systems

### STUDIO

104	STUDIO Rondo
112	STUDIO Classic
118	STUDIO Gala 2.0
124	STUDIO Arcos
130	STUDIO1121
134	STUDIO Medio

### OFFICE

138	OFFICE Junior
144	OFFICE Classic
150	OFFICE Mundus
154	OFFICE Arcos

### 157 Special hinges





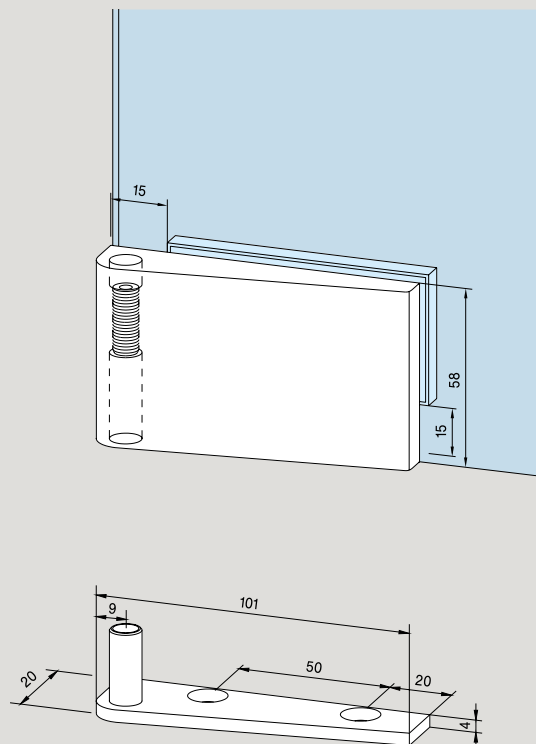

#### General accessories for the single action door range

162	Frame pivots for internal doors
164	Frame pockets, push-on sleeves, strike plates, door stop EASY Stop
166	Door rails for internal doors
169	Floor bearings, profile cylinders, door bolts, door catches, floor sockets

### Example view for special hinges



## Complete sets and single components

Art. No.	Description	DIN	Base parts (000)    AL anod Silver (150)    AL anod sim. Stain-Steel satin (157)    AL anod Special (199)    AL p-coat Special color (399)				
			€/Piece	€/Piece	€/Piece	€/Piece	€/Piece
	<b>12.040</b> Set of corner hinges, for 8/10 mm glass thickness, door weight max 80 kg., door width max. 1100 mm, consisting of: 1 floor pivot 1 bottom corner hinge (height adjustable) 1 top-pivot 1 top corner hinge	LH	104,00	140,00	147,00	147,00	
	<b>12.041</b> do.	RH	104,00	140,00	147,00	147,00	
	<b>Single components</b>						
	<b>12.001</b> Pair of corner hinges for 8 mm glass thickness		57,00	86,50	89,00	89,00	
	<b>12.009</b> Pair of corner hinges for 10 mm glass thickness		61,00	88,00		92,00	
	<b>12.016</b> Pair of floor socket/top-pivot for 12.001 and 12.009		23,00				
	<b>12.014</b> Piece of floor socket/top-pivot left bottom/top right		12,50				
	<b>12.015</b> Piece of floor socket/top-pivot right bottom/left top		12,50				
	<b>12.003</b> Frame fixed pivot		12,50				
	<b>12.004</b> Screw-in pivot		11,00				



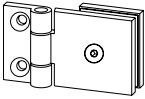
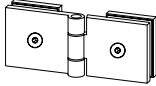

## Single components

Art. No.	Description	AL	AL	AL	AL
		anod Silver (150)	anod sim. Stain- Steel satin (157)	anod Special (199)	p-coat Special color (399)
		€/Piece	€/Piece	€/Piece	€/Piece
<b>Screw-on hinges</b>					
	<b>12.010</b> Screw-on hinge, 49 mm high, without cover caps	41,50	64,00	64,00	64,00
	<b>12.011</b> do., with 3 cover caps	50,50	78,50	78,50	78,50
	<b>12.012</b> do., with cover cap only for clamping plate, 86 mm high	50,50	78,50	78,50	78,50
<b>Screw-in hinges</b>					
	<b>12.030</b> Screw-in hinge, 49 mm high, without cover caps	49,00	71,00	71,00	71,00
	<b>12.031</b> do., with 4 cover caps	70,00	104,00	104,00	104,00
	<b>12.032</b> do., with cover caps only for clamping plates, 86 mm high	70,00	104,00	104,00	104,00







## Frame pivots for STUDIO Rondo / Classic / Gala / Arcos

Base  
parts  
(000)

	Art. No.	Description	€/Piece
	10.424	Frame pivot for wooden frames / STUDIO	6,10
	10.423	Frame pivot for steel frames / STUDIO	4,60
	10.407	Screw-on frame pivot / STUDIO	14,50









## Frame pivots for OFFICE Junior / Classic / Arcos

Base  
parts  
(000)

	Art. No.	Description	€/Piece
	11.310	Frame pivot for wooden frames / OFFICE	6,20
	11.309	Frame pivot for steel frames / OFFICE	4,60
	11.307	Frame pivot stainless steel, for steel frames	17,00
	11.405	Screw-on frame pivot / OFFICE not usable with door hinges 11.230/11.234 in finish satin stainless steel (700)	14,00
	11.308	Frame pivot for 120 mm frame pocket	9,00
	11.304	Frame pivot stainless steel for VX-frame pocket	21,00
	11.249	Frame pivot stainless steel for 160 mm frame pocket	20,00

Glass door fittings single-action

## Accessories for internal doors

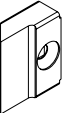
			Base parts (000)	AL anod Silver (150)	AL anod sim. Stainl-Steel satin (157)	AL p-coat Jet black (304)	AL anod Special (199)	AL p-coat Special color (399)
Art. No.	Description	€/Piece	€/Piece	€/Piece	€/Piece	€/Piece	€/Piece	€/Piece
<b>Frame pockets</b>								
	<b>10.405</b> Frame pocket for wooden frames	4,60						
	<b>10.406</b> Frame pocket for steel frames	4,60						
<b>Push-on sleeves</b>								
	<b>10.408</b> Push-on sleeve for STUDIO	4,60	6,10		6,10			
	<b>11.311</b> Push-on sleeve for OFFICE	4,60	4,60		6,20		6,20	
<b>Strike plates</b>								
	<b>10.401</b> Corner strike plate, aluminium for 24 mm rebate depth for STUDIO	11,00	17,00	17,00	19,50	19,50		
	<b>10.411</b> do. but with 16 mm side piece	11,00	17,50					
	<b>10.421</b> Strike plate, stainless steel for 40 mm rebate depth for STUDIO	7,60						
	<b>10.422</b> Strike plate, brass for 40 mm rebate depth for STUDIO	7,60						
	<b>11.313</b> Corner strike plate, aluminium for 24 mm rebate depth for OFFICE	24,00						
					brass satin nickel-plated (101)			
<b>Special single latch STUDIO</b>								
	<b>10.066</b> Single latch for Austrian norm frames and for the combination of 10 mm glass with a 24 mm rebate depth. Usable for STUDIO Rondo, Classic, Gala and Arcos	11,00						

## Accessories for internal doors

AL  
anod  
EV1  
(101)

Art. No.	Description	€/Piece
<b>Barrier free door stopper – Easy Stop</b>		
	<b>10.591</b> Easy Stop for single action doors, for 8 mm glass. Stainless steel adapter to glue onto glass (UV-gluing) with plastic cap	<b>171,00</b>
	<b>10.595</b> Easy Stop for tubular frame doors and timber doors	<b>171,00</b>

Glass door fittings single-action





## Accessories for internal doors

AL  
anod  
Silver  
(150)

AL  
anod  
sim.  
Stain-  
Steel  
satin  
(157)

Art. No.	Description	€/Piece	€/Piece
	<p><b>Push-over door rail with automatic drop-down seal GS-H8/12 for on-site gluing</b> for doors with glass thicknesses 8 - 12 mm, stainless steel cover on lock side, shortenability 125 mm, one-sided release, stroke 11 mm</p>		
12.430	833 mm	206,00	242,00
12.435	958 mm	218,00	256,00
12.440	1083 mm	231,00	267,00
12.445	1208 mm	242,00	279,00
	<p><b>Door rail with automatic drop-down seal GS-A, self-adhesive, suitable for retrofitting,</b> for doors with glass thicknesses from 6 mm, shortenability 125 mm, one-sided release, stroke 11 mm</p>		
12.434	833 mm	218,00	256,00
12.439	958 mm	231,00	267,00
12.444	1083 mm	242,00	279,00
12.449	1208 mm	256,00	292,00

## Accessories for internal doors

Art. No.	Description	Base parts (000)	AL anod Silver (150)	AL anod sim. Stain-Steel satin (157)	AL anod Special (199)	AL p-coat Special color (399)
		€/Piece	€/Piece	€/Piece	€/Piece	€/Piece
<b>Door rails with pair of plastic end caps, for 8 mm glass thickness</b>						
	<b>12.102</b>	Standard length 834 mm	50,50	71,00	81,50	81,50
	<b>12.103</b>	Standard length 959 mm	56,00	79,50	91,00	91,00
	<b>12.104</b>	Stock length 1200 mm	65,50	86,50	105,00	105,00
	<b>12.100</b>	Fixed length up to 1200 mm	69,50	90,00	111,00	111,00
	<b>Door rails with pair of plastic end caps, for 10 mm glass thickness</b>					
	<b>12.122</b>	Standard length 834 mm	56,00	79,50	90,00	90,00
	<b>12.123</b>	Standard length 959 mm	63,50	88,00	100,00	100,00
	<b>12.124</b>	Stock length 1200 mm	73,00	94,00	116,00	116,00
	<b>12.120</b>	Fixed length up to 1200 mm	76,50	99,50	120,00	120,00
	<b>Brush seals for door rails</b>					
	<b>12.115</b>	Stock length 1000 mm	21,50			
	<b>12.110</b>	Stock length 2000 mm	44,00			
	<b>12.116</b>	Fixed length up to 1000 mm	26,00			
	<b>12.111</b>	Fixed length 1001 - 1200 mm	31,00			
<b>Plastic end cap for door rails for 8 mm glass thickness</b>						
	<b>12.106</b>	Plastic end cap for door rail, black	4,80			
	<b>12.107</b>	Plastic end cap for door rail, white	4,80			
<b>Plastic end cap for door rails for 10 mm glass thickness</b>						
	<b>12.108</b>	Plastic end cap for door rail, black	4,80			
	<b>12.109</b>	Plastic end cap for door rail, white	4,80			







## Accessories for internal doors

Art. No.	Description	DIN	AL	AL	AL	AL	
			anod Silver (150)	anod sim. Stain- Steel satin (157)	anod Special (199)	p-coat Special color (399)	€/Piece
<b>Door rails with PVC draught strip for 8 mm glass thickness for sliding onto the glass (clamping without gluing)</b>							
	<b>12.202</b>	Standard length 834 mm	LH	186,00	226,00	243,00	243,00
	<b>12.203</b>	do.	RH	186,00	226,00	243,00	243,00
	<b>12.204</b>	Standard length 959 mm	LH	190,00	233,00	259,00	259,00
	<b>12.205</b>	do.	RH	190,00	233,00	259,00	259,00
	<b>12.200</b>	Fixed length up to 1200 mm	LH	202,00	240,00	268,00	268,00
	<b>12.201</b>	do.	RH	202,00	240,00	268,00	268,00
<b>Door rails with PVC draught strip for 10 mm glass thickness for sliding onto the glass (clamping without gluing)</b>							
	<b>12.212</b>	Standard length 834 mm	LH	186,00	228,00	243,00	243,00
	<b>12.213</b>	do.	RH	186,00	228,00	243,00	243,00
	<b>12.214</b>	Standard length 959 mm	LH	193,00	233,00	259,00	259,00
	<b>12.215</b>	do.	RH	193,00	233,00	259,00	259,00
	<b>12.210</b>	Fixed length up to 1200 mm	LH	202,00	240,00	268,00	268,00
	<b>12.211</b>	do.	RH	202,00	240,00	268,00	268,00

















## Lock keeper plates, floor sockets, profile cylinders

Base  
parts  
(000)

Art. No.	Description	€/Piece
	<b>05.190</b> Lock keeper plate, stainless steel, adjustable	16,50
	<b>05.192</b> Floor socket	8,50
	<b>05.193</b> Floor socket, dirt protection	17,50
	<b>05.194</b> Eccentric socket, adjustable	28,00
	<b>05.001</b> Profile cylinder, length 61 mm long, differently keyed,	30,50
	<b>05.002</b> do., equally keyed	30,50
	<b>05.003</b> Half profile cylinder length, 31 mm differently keyed,	28,50
	<b>05.004</b> do., equally keyed	28,50

Glass door fittings single-action

## Thumbturn cylinders, door bolts, door catch

			Base parts (000)	AL anod Silver (150)	AL anod sim. Stainl-Steel satin (157)	AL anod Special (199)	AL p-coat Special color (399)	
	Art. No.	Description	€/Piece	€/Piece	€/Piece	€/Piece	€/Piece	
	10.310	dormakaba Thumbturn cylinder (Toilet version)		Brass p-coat silver <b>111,00</b>	Brass p-coat steel <b>113,00</b>		<b>125,00</b>	
	10.311	dormakaba Thumbturn half-cylinder		Brass p-coat silver <b>78,00</b>	Brass p-coat steel <b>79,50</b>		<b>98,50</b>	
	10.336	dormakaba Thumbturn cylinder with locking/unlocking function by key (profile cylinder) on thumbturn-counter side		Brass p-coat silver <b>146,00</b>	Brass p-coat steel <b>148,00</b>		<b>163,00</b>	
	12.301	Slide-on door bolt for 8 mm glass thickness		<b>50,50</b>	<b>76,50</b>	<b>90,00</b>	<b>90,00</b>	
	12.314	Slide-on strike-box for 12.301 for 8 mm glass thickness		<b>50,50</b>	<b>76,50</b>	<b>90,00</b>	<b>90,00</b>	
	12.302	Slide-on door bolt for 10 mm glass thickness		<b>51,50</b>	<b>78,00</b>	<b>91,00</b>	<b>91,00</b>	
	12.317	Slide-on strike-box for 12.302 for 10 mm glass thickness		<b>51,50</b>	<b>72,50</b>	<b>91,00</b>	<b>91,00</b>	
	12.312	Door bolt on glass holes for 8 mm glass thickness		<b>50,50</b>	<b>76,50</b>	<b>90,00</b>	<b>90,00</b>	
	12.313	Strike-box on glass holes for 12.312 for 8 mm glass thickness		<b>50,50</b>	<b>76,50</b>	<b>90,00</b>	<b>90,00</b>	
	12.315	Door bolt on glass holes for 10 mm glass thickness		<b>51,50</b>	<b>78,00</b>	<b>91,00</b>	<b>91,00</b>	
	12.318	Door bolt with free glass edge, on glass holes for 8 and 10 mm glass thickness		<b>50,50</b>	<b>70,50</b>	<b>87,00</b>	<b>87,00</b>	
	12.316	Strike-box on glass holes for 12.315 for 10 mm glass thickness		<b>51,50</b>	<b>78,00</b>	<b>91,00</b>	<b>91,00</b>	
	12.300	Door catch, plastic		<b>17,50</b>				
	12.305	Door catch with round bolt		<b>17,00</b>				

## Notes

# TENSOR



Glass door fittings double action



Technical data	
Glass	TSG
Glass thickness	8, 10, 12 mm
Max. door weight	65 kg
Applications	1-/2 panels, sidelight
Material	Aluminium
Finishes	Anodised colors
Specials	Closing function without additional fitting element, hold open at 90° opening angle

## Manual double action door systems

**172** TENSOR

**176** MARCATO Motion

**180** RP - Frame profile with transom door closer

### General accessories for double action doors



**175** Door stops

**260** Centre and corner locks, strike boxes

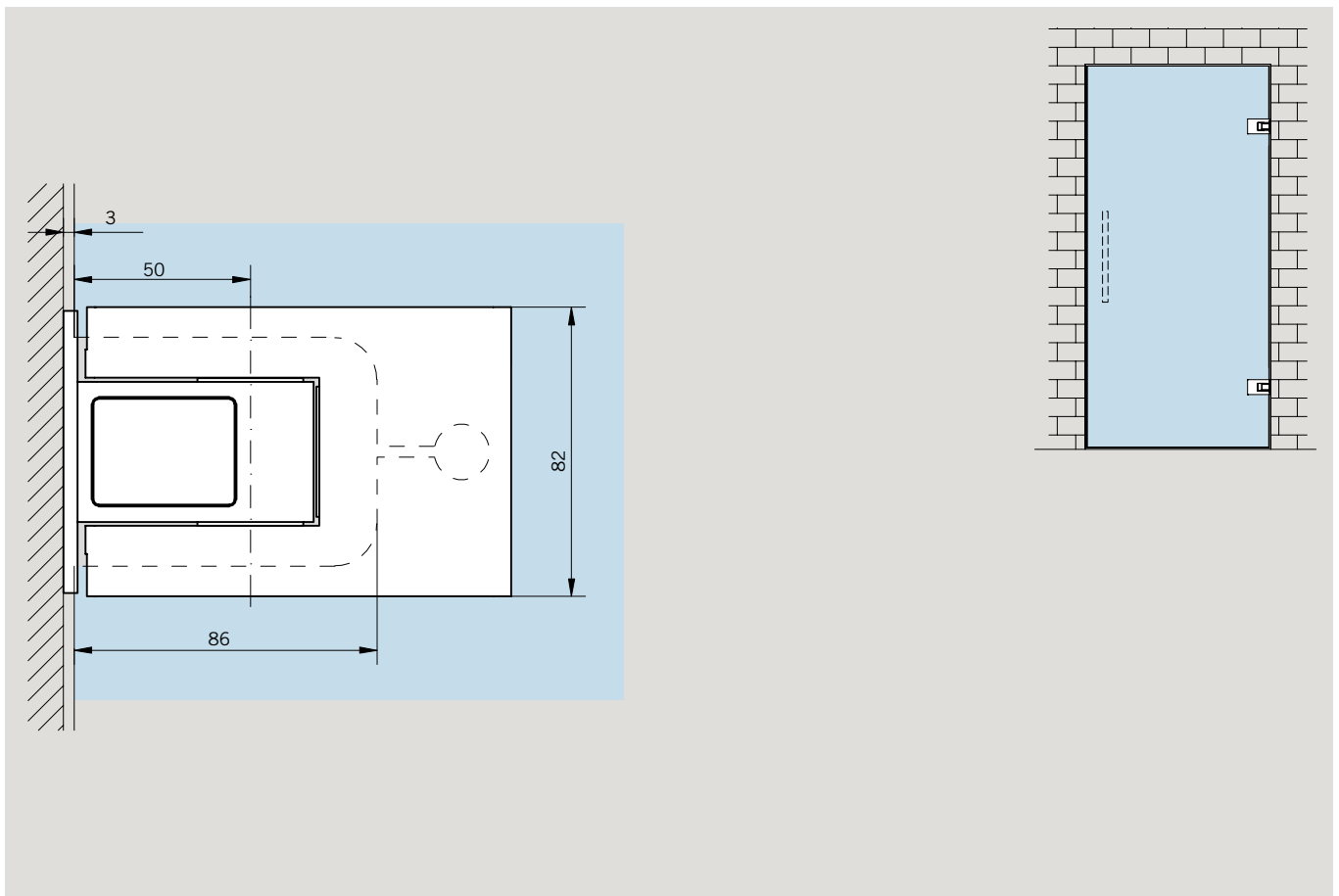
### Example view for TENSOR



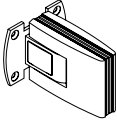
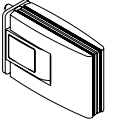
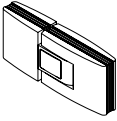
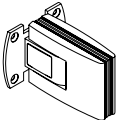
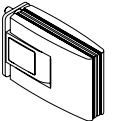
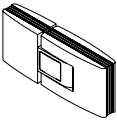

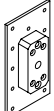



## Complete sets and single components

Art. No.	Description	Base parts (000)	AL anod EV1 Deco (114)	AL anod sim. Stainl-Steel satin (113)	AL p-coat Jet black (304)	AL p-coat Special color (399)
		€/Pair	€/Pair	€/Pair	€/Pair	
	<b>12.527</b> TENSOR – Pair of double action hinges incl. mounting plate, round; for installation onto wall or frame with surface mounted mounting plate, incl. 2 floor doorstops (Art. No. 29.950)	616,00	628,00	647,00		
	<b>12.528</b> TENSOR – Pair of double action hinges incl. mounting plate; for installation into frame with embedded mounting plate incl. 2 floor doorstops (Art. No. 29.950)	590,00	598,00	620,00		
	<b>12.529</b> TENSOR – Pair of double action hinges for installation glass to glass incl. 2 floor doorstops (Art. No. 29.950)	797,00	820,00	836,00		
<b>Single components</b>						
	<b>12.520</b> TENSOR – Pair of double action hinges incl. mounting plate, round; for installation onto wall or frame with surface mounted mounting plate	574,00	589,00	604,00	634,00	
	<b>12.522</b> TENSOR – Pair of double action hinges incl. mounting plate; for installation into frame with embedded mounting plate	548,00	558,00	576,00	605,00	
	<b>12.523</b> TENSOR – Pair of double action hinges for installation glass to glass	754,00	781,00	793,00	833,00	
	<b>12.536</b> Overpanel-sidepanel connector	€/Piece 44,50	€/Piece 53,50			
	<b>12.526</b> Embedded mounting plate	86,50				

Accessories

AL  
anod  
EV1  
(101)      Stainl-  
Steel  
satin  
(700)

Art. No.	Description	€/Piece	€/Piece
<b>Barrier free door stop – Easy Stop</b>			
	<b>10.592</b> Easy Stop for double action doors – for 8 mm glass stainless steel adapter to glue onto glass, plastic cap	287,00	
	<b>10.593</b> Easy Stop for double action doors – for 10 mm glass stainless steel adapter to glue onto glass, plastic cap	287,00	
	<b>10.594</b> Easy Stop for double action doors – for 12 mm glass stainless steel adapter to glue onto glass, plastic cap	287,00	
	<b>29.950</b> Floor doorstop	40,00	
	<b>29.951</b> Wall doorstop, short	38,00	
	<b>29.952</b> Wall doorstop, long	43,00	

Glass door fittings double action

# MARCATO Motion



Glass door fittings double action



Technical data	
Glass	TSG
Glass thickness	8, 10, 12 mm
Max. door weight	65 kg
Applications	1-/2 panels, sidelight
Material	Aluminium
Finishes	Anodised colors
Specials	Hydraulic closing function with adjustable closing speed, without any additional fitting elements Hold open at 90° opening angle



## Manual double action door systems

**172** TENSOR

**176** MARCATO Motion

**180** RP - Frame profile with transom door closer

### General accessories for double action doors

**175** Door stops



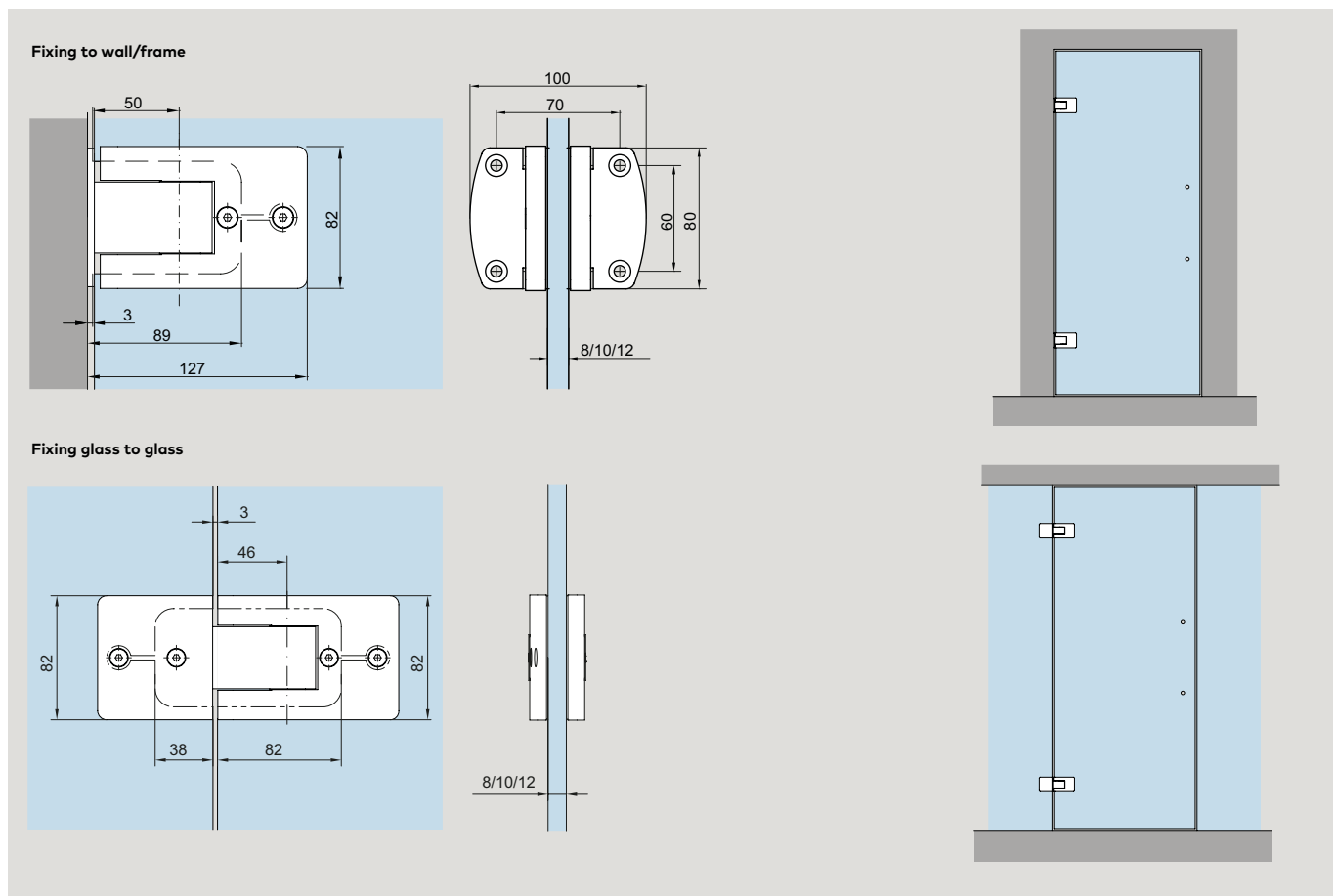

**260** Centre and corner locks, strike boxes

### Example view for MARCATO Motion

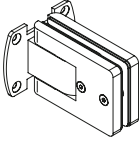
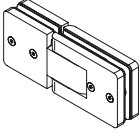

Glass door fittings double action

## Komplett-Sets und Zubehör

		AL anod EV1 (101)	AL anod Silver (150)	AL anod sim. Stain- Steel satin (157)	Stain- Steel satin (700)
Art. No.	Description	€/Pair	€/Pair	€/Pair	€/Pair
<b>Sets</b>					
	<b>12.700</b> MARCATO Motion – Pair of double action hinges; for installation onto wall or frame with surface mounted mounting plate		<b>597,00</b>	<b>608,00</b>	
	<b>12.710</b> MARCATO Motion – Pair of double action hinges for installation glass to glass		<b>784,00</b>	<b>811,00</b>	
<b>Barrier free door stop – Easy Stop</b>					
	<b>10.592</b> Easy Stop for double action doors – for 8 mm glass stainless steel adapter to glue onto glass, plastic cap	€/Piece	<b>287,00</b>		
	<b>10.593</b> Easy Stop for double action doors – for 10 mm glass stainless steel adapter to glue onto glass, plastic cap	€/Piece	<b>287,00</b>		
	<b>10.594</b> Easy Stop for double action doors – for 12 mm glass stainless steel adapter to glue onto glass, plastic cap	€/Piece	<b>287,00</b>		
	<b>29.950</b> Floor doorstop				€/Piece <b>40,00</b>

Glass door fittings double action

## Notes

# RP



Glass door fittings double action

Technical data	
Glass	TSG
Glass thickness	8, 10, 12 mm
Max. door weight	110 kg
Applications	1-/2 panels, sidelight, glass assembly
Material	Aluminium
Finishes	Anodised- and RAL-Colors (coated)
Specials	Alternative for floor spring Integrated transom closer

## Manual double action door systems

**172** TENSOR

**176** MARCATO Motion

**180** RP - Frame profile with transom door closer

### General accessories for double action doors



**175** Door stops

**260** Centre and corner locks, strike boxes

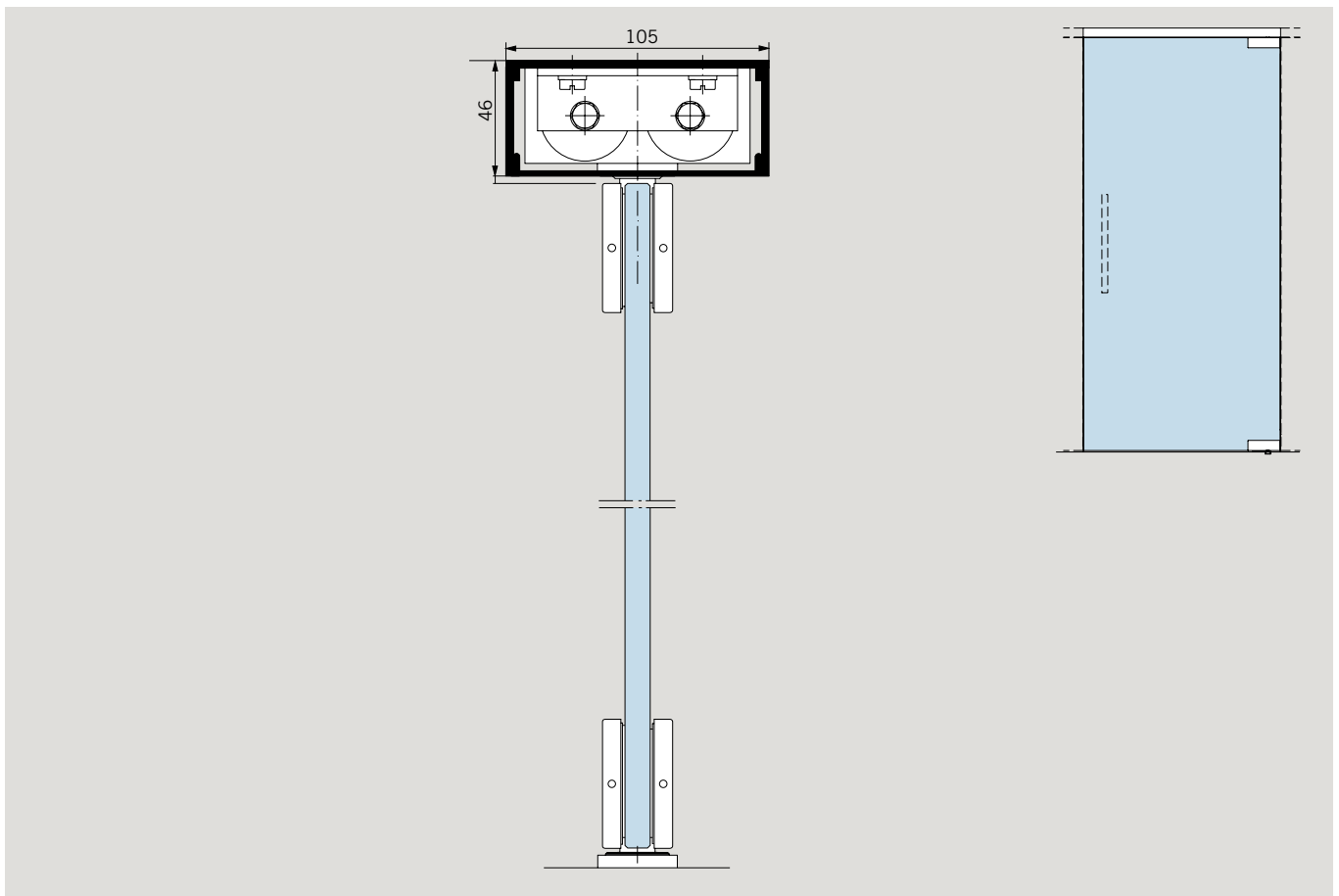

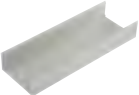

Example view for RP-Frame profile with transom door closer

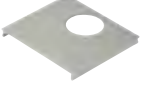

## Complete sets and single components

Art. No.	Description	AL anod EV1 (101)	AL anod sim. Stain- Steel satin (113)	AL anod Special (199)	AL p-coat Special color (399)
		€/m	€/m	€/m	€/m
<b>Complete set</b>					
	<b>01.300 Set dormakaba RTS-System</b> consisting of:  1 m transom tube 01.301 1 m cover profile 01.302 1 dormakaba RTS 85 EN3 (= size 2) with 90° hold open, completely installed in frame 1 fixing bracket 01.306. for wall fixing, installed 1 bottom patch fitting PT 10 1 top patch fitting PT 22 1 floor pivot bearing 01.106	€/Piece <b>692,00</b>	€/Piece <b>874,00</b>	€/Piece <b>907,00</b>	€/Piece <b>907,00</b>
	Other assemblies, e.g. with side light for VSG with MUNDUS fittings, for larger panel widths with door rails or in other lengths: on request.				
<b>Single components</b>					
	<b>01.311</b> Transom tube 105/46 for dormakaba RTS, fixed length	<b>59,00</b>	<b>83,00</b>	<b>93,00</b>	<b>93,00</b>
	<b>01.301</b> Transom tube 105/46 for dormakaba RTS 6000 mm stock length	€/Piece <b>282,00</b>	€/Piece <b>392,00</b>	€/Piece <b>450,00</b>	€/Piece <b>450,00</b>
	<b>01.305</b> Cover profile for 01.301/311 fixed length	<b>26,50</b>	<b>47,50</b>	<b>51,50</b>	<b>51,50</b>
	<b>01.302</b> Cover profile for 01.301/311 6000 mm stock length  <b>max. 1100 mm with patch fitting</b> <b>max. 1250 mm with door rail</b>	€/Piece <b>125,00</b>	€/Piece <b>228,00</b>	€/Piece <b>252,00</b>	€/Piece <b>252,00</b>

## Single components

Art. No.	Description	Base parts (000)	AL anod EV1 (101)	AL anod sim. Stain-Steel satin (113)	AL anod Special (199)	AL p-coat Special color (399)
		€/m	€/m	€/m	€/m	€/m
	<b>01.303</b> Cover plate of 01.302		€/Piece <b>23,50</b>	€/Piece <b>33,50</b>	€/Piece <b>38,00</b>	€/Piece <b>38,00</b>
	<b>01.314</b> Cover profile with glass groove to clip on art.no. 01.301/311, to hold fixed sidelights incl. contact and glass wedge profile for 8, 10 and 12 mm glass thickness, fixed length		<b>41,00</b>	<b>61,00</b>	<b>64,50</b>	<b>64,50</b>
	<b>01.304</b> Cover profile with glass groove to clip on art.no. 01.301/311, to hold fixed sidelights incl. contact and glass wedge profile for 8, 10 and 12 mm glass thickness, 6000 mm stock length		€/Piece <b>193,00</b>	€/Piece <b>301,00</b>	€/Piece <b>315,00</b>	€/Piece <b>315,00</b>
	<b>01.306</b> Fixing bracket for wall		€/Piece <b>12,50</b>			
	<b>U-Profile 20 x 20 x 20 x 2 mm</b>		(100)			
	<b>07.092</b> Stock length 6000 mm		€/Piece <b>36,00</b>	€/Piece <b>51,50</b>	€/Piece <b>88,00</b>	€/Piece <b>91,50</b>
	<b>07.093</b> Fixed length		€/m <b>7,40</b>	€/m <b>10,50</b>	€/m <b>17,50</b>	€/m <b>18,00</b>
	<b>U-Profile 30 x 20 x 30 x 2 mm</b>					
	<b>07.097</b> Stock length 6000 mm		€/Piece <b>70,50</b>	€/Piece <b>125,00</b>	€/Piece <b>128,00</b>	€/Piece <b>128,00</b>
	<b>07.096</b> Fixed length		€/m <b>15,00</b>	€/m <b>26,50</b>	€/m <b>27,00</b>	€/m <b>27,00</b>

Glass door fittings double action

# MUNDUS Comfort



Technical data	
Glass	TSG
Glass thickness	8-12 mm (for door panels)
Max. door weight	150 kg
Lock application	Euro profile cylinder, round cylinder
Applications	single/double leaf, sidelights, overpanels, glass assembly
Material	Aluminium, stainless steel
Finishes	Satin & polished stainless steel, anodised colors, powder coated
Specials	Multi dimensional adjustability For infinitely variable glass thicknesses (8 - 12 mm for door panels) Longevity: 500.000 cycles



## Fittings for toughened glass assemblies

- 184** Patch fitting MUNDUS Comfort
- 190** Patch fitting MUNDUS Premium
- 198** Patch fitting UNIVERSAL
- 207** Patch fitting UNIVERSAL Motion NG33
- 208** Patch fitting UNIVERSAL light
- 210** Single action door fitting BEYOND
- 216** EA-Patch fittings for single action doors
- 222** Door rails TP/TA EASY Safe
- 234** Door rails TP/TA 76.5
- 242** Single action door fitting MANET
- 250** Wall connecting profiles
- 256** Frame systems MR 22 & MR 28
- 260** Centre and corner locks SG, strike boxes

### General accessories for toughened glass assemblies

- 270** Clamping fitting, U-profile
- 271** Pivot bearing, floor bearing, strike plates, floor sockets, profile cylinders

### Example view for MUNDUS Comfort

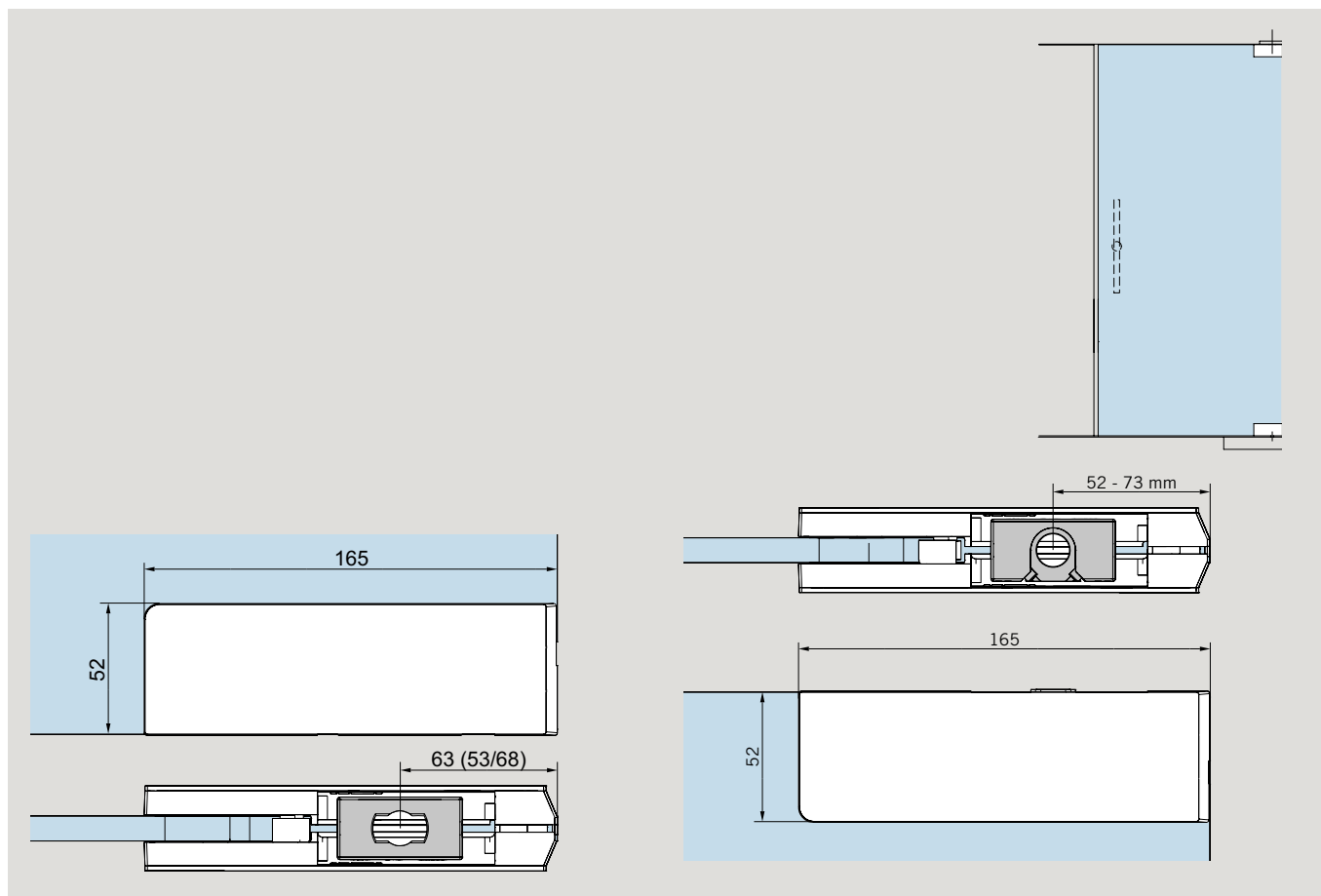

Glass assemblies

## Patch fittings

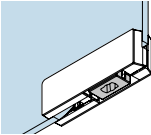
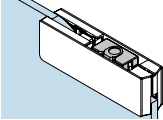
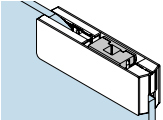
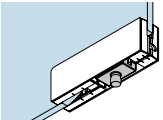
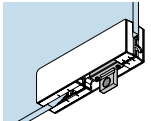
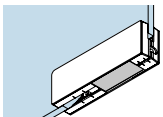
		AL anod Silver (150)	Stain- Steel satin (750)	Stain- Steel polished (751)	AL p-coat Special color (399)
Art. No.	Description	€/Piece	€/Piece	€/Piece	€/Piece
<b>Single components</b>					
	<b>PT 10 Comfort bottom patch fitting</b> For glass weight up to 150 kg and use with toughened safety glass (TSG ). With insert for flat-conical floor spring spindle or round pivot Ø 14 mm.				
38.100	8-12 mm	93,00	93,00	93,00	103,00
	<b>PT 20 Comfort top patch fitting</b> For glass weight up to 150 kg and use with toughened safety glass (TSG ). With plastic socket for pivot Ø 14 mm.				
38.200	8-12 mm	93,00	93,00	93,00	103,00
	<b>PT 22 Comfort top patch fitting</b> For use with toughened safety glass (TSG ). With insert for transom closer dormakaba RTS.				
38.220	8-12 mm	112,00	112,00	112,00	123,00
	<b>PT 30 Comfort overpanel patch fitting</b> For use with toughened safety glass (TSG ). With pivot Ø 14 mm and M 8 tapped hole at side				
38.300	8-12 mm	93,00	93,00	93,00	103,00
	<b>PT 30 Comfort overpanel patch fitting</b> For use with toughened safety glass (TSG ) With stop insert.				
38.303	8-15 mm	93,00	93,00	93,00	103,00
	<b>PT 30 Comfort overpanel patch fitting</b> For use with toughened safety glass (TSG ). With blank insert.				
38.306	8-15 mm	93,00	93,00	93,00	103,00

## Patch fittings





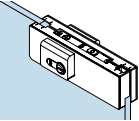
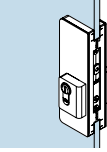
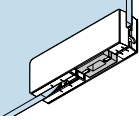
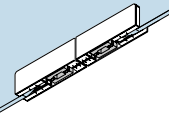
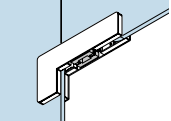
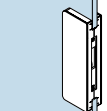



Art. No.	Description	DIN	AL anod Silver (150)	Stainl-Steel satin (750)	Stainl-Steel polished (751)	AL p-coat Special color (399)
<b>Single components</b>						
	<b>PT 40 Comfort patch for overpanel and sidelight</b> For use with toughened safety glass (TSG ). With pivot Ø 14 mm.					
38.400	8-12 mm		129,00	129,00	129,00	142,00
	<b>PT 40 Comfort patch for overpanel and sidelight</b> For use with toughened safety glass (TSG ). With stop insert.					
38.403	8-15 mm		129,00	129,00	129,00	142,00
	<b>PT 40 Comfort patch for overpanel and sidelight</b> For use with toughened safety glass (TSG ). With blank insert					
38.406	8-15 mm		129,00	129,00	129,00	142,00
	<b>PT 41 Comfort patch for overpanel and sidelight</b> For use with toughened safety glass (TSG ). With pivot pin Ø 14 mm and fin fitting*.					
	<b>With pivot</b>					
38.410	8-12 mm	LH	279,00	279,00	279,00	307,00
38.420	8-12 mm	RH	279,00	279,00	279,00	307,00
	<b>With stop insert</b>					
38.413	8-15 mm	LH	279,00	279,00	279,00	307,00
38.423	8-15 mm	RH	279,00	279,00	279,00	307,00
	<b>With blank insert</b>					
38.416	8-15 mm	LH	279,00	279,00	279,00	307,00
38.426	8-15 mm	RH	279,00	279,00	279,00	307,00
	<b>PT 60 Comfort connector</b> For use with toughened safety glass (TSG ). For double and single action doors. With 1 stop insert and 2 blank inserts.					
38.600	8-15 mm		92,00	92,00	92,00	102,00
	<b>PT 70 Comfort overpanel connector</b> For use with toughened safety glass (TSG ). With 2 stop inserts and 2 blank inserts.					
38.700	8-15 mm		80,00	80,00	80,00	88,50

## Locks and strike boxes

		AL anod Silver (150)	Stain- Steel satin (750)	Stain- Steel polished (751)	AL p-coat Special color (399)
Art. No.	Description	€/Piece	€/Piece	€/Piece	€/Piece
<b>Single components</b>					
<b>US 10 Comfort corner lock</b> 8-19 mm glass thickness					
	<b>38.510</b> Euro profile cylinder, for use with toughened safety glass (TSG )	129,00	129,00	129,00	142,00
	<b>38.513</b> round cylinder, for use with toughened safety glass (TSG ).	129,00	129,00	129,00	142,00
<b>US 20 Comfort center lock</b> 8-19 mm glass thickness					
	<b>38.520</b> Euro profile cylinder, for use with toughened safety glass (TSG ).	129,00	129,00	129,00	142,00
	<b>38.523</b> round cylinder, for use with toughened safety glass (TSG ).	129,00	129,00	129,00	142,00
<b>For suitable center locks for single-action doors in our MUNDUS design see pages 216 / 217</b>					
<b>GK 30 Comfort single overpanel strike box</b> For use with toughened safety glass (TSG ). With tapped hole at side. Suitable for corner lock US 10.					
	<b>38.530</b> 8-12 mm	129,00	129,00	129,00	142,00
<b>GK 20 Comfort double overpanel strike box</b> consisting of two GK 30 with threaded connecting bolt. For use with toughened safety glass (TSG ). Suitable for corner lock US 10					
	<b>38.526</b> 8-12 mm	260,00	260,00	260,00	287,00
<b>GK 40 Comfort corner overpanel strike box</b> For use with toughened safety glass (TSG ). Suitable for corner lock US 10.					
	<b>38.540</b> 8-12 mm	149,00	149,00	149,00	163,00
<b>GK 50 Comfort strike box</b> For use with toughened safety glass (TSG ). Suitable for center lock US 20.					
	<b>38.550</b> 8-19 mm	129,00	129,00	129,00	142,00

Note: Please specify the exact glass thickness when ordering!

Accessories

Art. No.	Description	Base parts (000)	AL anod Silver (150)	Al p-coat Traffic white (350)	Stain-Steel satin (750)	Stain-Steel polished (751)
		€/Piece	€/Piece	€/Piece	€/Piece	€/Piece
<b>Single components</b>						
	<b>38.210</b> MUNDUS PT 21, top pivot with retractable bolt 14 mm Ø	47,50				
	<b>38.211</b> MUNDUS PT 21, top pivot with retractable bolt 14 mm Ø and coverplate	51,50	51,50	51,50		
	<b>38.240</b> MUNDUS PT 24, pivot 14 mm Ø, with fixing plate 6 mm, to let into the brickwork	19,50	19,50			
	<b>38.241</b> MUNDUS PT 24, pivot 14 mm Ø, with fixing plate 3 mm, to screw onto the brickwork	19,50	19,50	19,50		
	<b>38.250</b> MUNDUS PT 25 pivot 14 mm Ø, with plug	7,10				
	<b>01.133</b> Wall anchor, zinc plated for PT 30	8,60				
	<b>01.134</b> Threaded rod with wall plug, for PT 30	8,60				
	<b>38.313</b> MUNDUS fixing plate for PT 30 / GK 30			(st.st., white powder coated)	19,50	19,50

Patch fittings and profile systems

# MUNDUS Premium



Technical data	
Glass	TSG, LSG (2 x TSG)
Glass thickness	8 - 22 mm
Max. door weight	200 kg
Lock application	Euro profile cylinder, round cylinder
Applications	Single/double leaf, sidelights, overpanels, glass assembly
Material	Aluminium, Stainless steel
Finishes	Anodised colors, powder coated, satin & polished stainless steel
Specials	Multi dimensional adjustability For infinitely variable glass thicknesses (8 - 22 mm) Longevity: 1.000.000 cycles

## Fittings for toughened glass assemblies

- 184** Patch fitting MUNDUS Comfort
- 190** Patch fitting MUNDUS Premium
- 198** Patch fitting UNIVERSAL
- 207** Patch fitting UNIVERSAL Motion NG33
- 208** Patch fitting UNIVERSAL light
- 210** Single action door fitting BEYOND
- 216** EA-Patch fittings for single action doors
- 222** Door rails TP/TA EASY Safe
- 234** Door rails TP/TA 76.5
- 242** Single action door fitting MANET
- 250** Wall connecting profiles
- 256** Frame systems MR 22 & MR 28
- 260** Centre and corner locks SG, strike boxes

### General accessories for toughened glass assemblies

- 270** Clamping fitting, U-profile
- 271** Pivot bearing, floor bearing, strike plates, floor sockets, profile cylinders

### Example view for MUNDUS Premium

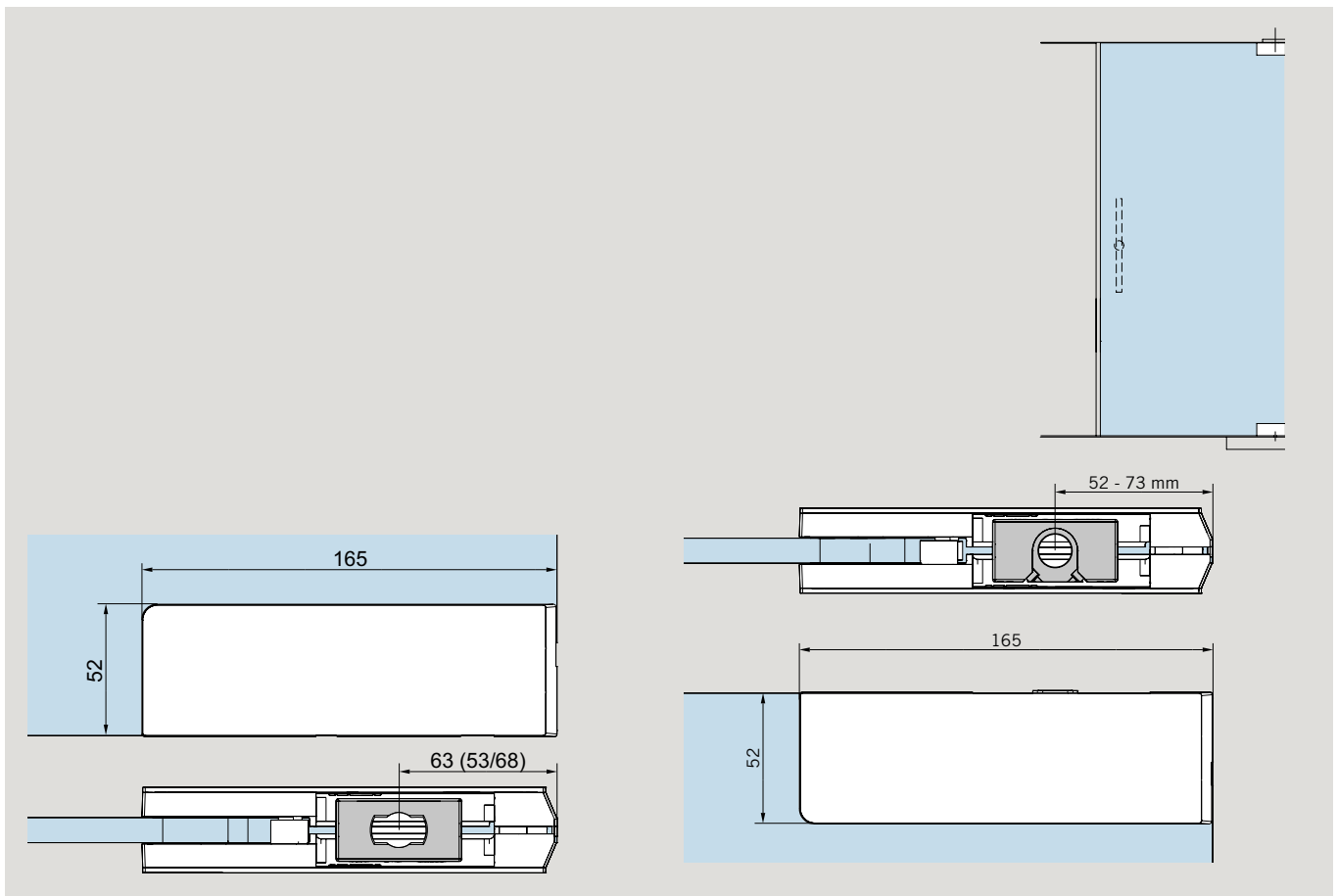

## Patch fittings

AL anod Silver (150)	Stain- Steel satin (750)	Stain- Steel polished (751)	AL anod Special (199)	AL p-coat Special color (399)
-------------------------------	-----------------------------------	--------------------------------------	--------------------------------	-------------------------------------------

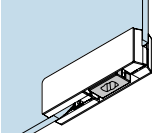
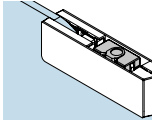
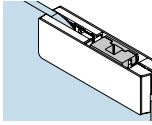
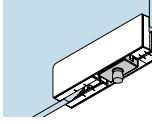
Art. No.	Description	€/Piece	€/Piece	€/Piece	€/Piece	€/Piece	
<b>Single components</b>							
<b>PT 10 Premium bottom patch fitting</b>							
For glass weight up to 200 kg and use with toughened safety glass (TSG). Also prepared for use with laminated safety glass (LSG). With insert for flat-conical floor spring spindle or round pivot Ø 14 mm.							
	42.100	8-12 mm	125,00	125,00	125,00	137,00	137,00
	42.101	12-15 mm	146,00	146,00	146,00	158,00	158,00
	42.102	15-19 mm	173,00	173,00	173,00	188,00	188,00
	42.103	19-22 mm	201,00	201,00	201,00	221,00	221,00
<b>PT 20 Premium top patch fitting</b>							
For glass weight up to 200 kg and use with toughened safety glass (TSG). Also prepared for use with laminated safety glass (LSG). With plastic socket for pivot Ø 14 mm.							
	42.200	8-12 mm	125,00	125,00	125,00	137,00	137,00
	42.201	12-15 mm	146,00	146,00	146,00	158,00	158,00
	42.202	15-19 mm	173,00	173,00	173,00	188,00	188,00
	42.203	19-22 mm	201,00	201,00	201,00	221,00	221,00
<b>PT 22 Premium top patch fitting</b>							
For use with toughened safety glass (TSG). Also prepared for use with laminated safety glass (LSG). With insert for transom closer dormakaba RTS.							
	42.220	8-12 mm	145,00	145,00	145,00	157,00	157,00
	42.221	12-15 mm	162,00	162,00	162,00	180,00	180,00
	42.222	15-19 mm	191,00	191,00	191,00	210,00	210,00
	42.223	19-22 mm	219,00	219,00	219,00	240,00	240,00
<b>PT 30 Premium overpanel patch fitting</b>							
For use with toughened safety glass (TSG). Also prepared for use with laminated safety glass (LSG). With pivot Ø 14 mm and M 8 tapped hole at side.							
	42.300	8-12 mm	125,00	125,00	125,00	137,00	137,00
	42.301	12-15 mm	146,00	146,00	146,00	158,00	158,00
	42.302	15-19 mm	173,00	173,00	173,00	188,00	188,00
	42.310	19-22 mm	201,00	201,00	201,00	221,00	221,00



## Patch fittings

AL anod Silver (150)	Stainl- Steel satin (750)	Stainl- Steel polished (751)	AL anod Special (199)	AL p-coat Special color (399)
-------------------------------	------------------------------------	---------------------------------------	--------------------------------	-------------------------------------------

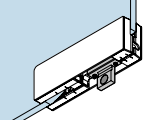
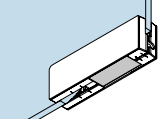
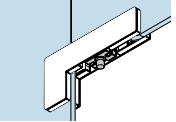
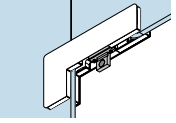
Art. No.	Description	€/Piece	€/Piece	€/Piece	€/Piece	€/Piece
<b>Single components</b>						
<b>PT 30 Premium overpanel patch fitting</b>						
For use with toughened safety glass (TSG). Also prepared for use with laminated safety glass (LSG) With stop insert.						
	<b>42.303</b> 8-15 mm	125,00	125,00	125,00	137,00	137,00
	<b>42.305</b> 15-19 mm	173,00	173,00	173,00	188,00	188,00
	<b>42.311</b> 19-22 mm	201,00	201,00	201,00	221,00	221,00
<b>PT 30 Premium overpanel patch fitting</b>						
For use with toughened safety glass (TSG). Also prepared for use with laminated safety glass (LSG) With blank insert.						
	<b>42.306</b> 8-15 mm	125,00	125,00	125,00	137,00	137,00
	<b>42.308</b> 15-19 mm	173,00	173,00	173,00	188,00	188,00
	<b>42.312</b> 19-22 mm	201,00	201,00	201,00	221,00	221,00
<b>PT 40 Premium patch for overpanel and sidelight</b>						
For use with toughened safety glass (TSG). Also prepared for use with laminated safety glass (LSG) With pivot Ø 14 mm.						
	<b>42.400</b> 8-12 mm	155,00	155,00	155,00	172,00	172,00
	<b>42.401</b> 12-15 mm	175,00	175,00	175,00	192,00	192,00
	<b>42.402</b> 15-19 mm	203,00	203,00	203,00	223,00	223,00
	<b>42.470</b> 19-22 mm	231,00	231,00	231,00	255,00	255,00
<b>PT 40 Premium patch for overpanel and sidelight</b>						
For use with toughened safety glass (TSG). Also prepared for use with laminated safety glass (LSG) With stop insert.						
	<b>42.403</b> 8-15 mm	155,00	155,00	155,00	172,00	172,00
	<b>42.405</b> 15-19 mm	203,00	203,00	203,00	223,00	223,00
	<b>42.471</b> 19-22 mm	231,00	231,00	231,00	255,00	255,00

## Patch fittings and connector patches

AL anod Silver (150)	Stainl- Steel satin (750)	Stainl- Steel polished (751)	AL anod Special (199)	AL p-coat Special color (399)
-------------------------------	------------------------------------	---------------------------------------	--------------------------------	-------------------------------------------

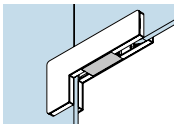
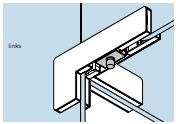
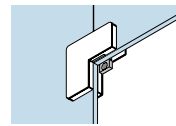
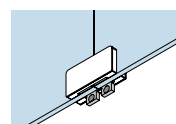
Art. No.	Description	DIN	€/Piece	€/Piece	€/Piece	€/Piece	€/Piece
<b>Single components</b>							
<b>PT 40 Premium patch for overpanel and sidelight</b>							
For use with toughened safety glass (TSG). Also prepared for use with laminated safety glass (LSG). With blank insert.							
	<b>42.406</b> 8-15 mm		155,00	155,00	155,00	172,00	172,00
	<b>42.408</b> 15-19 mm		203,00	203,00	203,00	223,00	223,00
	<b>42.409</b> 19-22 mm		231,00	231,00	231,00	255,00	255,00
<b>PT 41 Premium patch for overpanel and sidelight</b>							
For use with toughened safety glass (TSG). Also prepared for use with laminated safety glass (LSG). With pivot pin Ø 14 mm and fin fitting*.							
	<b>42.410</b> 8-12 mm	LH	266,00	266,00	266,00	292,00	292,00
	<b>42.420</b> 8-12 mm	RH	266,00	266,00	266,00	292,00	292,00
	<b>42.411</b> 12-15 mm	LH	286,00	286,00	286,00	313,00	313,00
	<b>42.421</b> 12-15 mm	RH	286,00	286,00	286,00	313,00	313,00
	<b>42.412</b> 15-19 mm	LH	313,00	313,00	313,00	346,00	346,00
	<b>42.422</b> 15-19 mm	RH	313,00	313,00	313,00	346,00	346,00
	<b>42.472</b> 19-22 mm	LH	341,00	341,00	341,00	376,00	376,00
	<b>42.474</b> 19-22 mm	RH	341,00	341,00	341,00	376,00	376,00
<b>With stop insert</b>							
	<b>42.413</b> 8-15 mm	LH	266,00	266,00	266,00	292,00	292,00
	<b>42.423</b> 8-15 mm	RH	266,00	266,00	266,00	292,00	292,00
	<b>42.415</b> 15-19 mm	LH	313,00	313,00	313,00	346,00	346,00
	<b>42.425</b> 15-19 mm	RH	313,00	313,00	313,00	346,00	346,00
	<b>42.473</b> 19-22 mm	LH	341,00	341,00	341,00	376,00	376,00
	<b>42.475</b> 19-22 mm	RH	341,00	341,00	341,00	376,00	376,00
<b>With blank insert</b>							
	<b>42.416</b> 8-15 mm	LH	266,00	266,00	266,00	292,00	292,00
	<b>42.426</b> 8-15 mm	RH	266,00	266,00	266,00	292,00	292,00
	<b>42.418</b> 15-19 mm	LH	313,00	313,00	313,00	346,00	346,00
	<b>42.428</b> 15-19 mm	RH	313,00	313,00	313,00	346,00	346,00
	<b>42.419</b> 19-22 mm	LH	341,00	341,00	341,00	376,00	376,00
	<b>42.429</b> 19-22 mm	RH	341,00	341,00	341,00	376,00	376,00
<b>PT 60 Premium connector</b>							
For use with toughened safety glass (TSG). Also prepared for use with laminated safety glass (LSG). For double and single action doors. with 1 stop insert and 2 blank inserts.							
	<b>42.600</b> 8-15 mm		106,00	106,00	106,00	118,00	118,00
	<b>42.602</b> 15-19 mm		154,00	154,00	154,00	168,00	168,00
	<b>42.603</b> 19-22 mm		182,00	182,00	182,00	201,00	201,00
<b>PT 70 Premium overpanel connector</b>							
For use with toughened safety glass (TSG). Also prepared for use with laminated safety glass (LSG). With 2 stop inserts and 2 blank inserts.							
	<b>42.700</b> 8-15 mm		98,50	98,50	98,50	107,00	107,00
	<b>42.702</b> 15-19 mm		147,00	147,00	147,00	159,00	159,00
	<b>42.703</b> 19-22 mm		174,00	174,00	174,00	191,00	191,00

\* Left hand fin (illustration shows left hand) / right hand fin. Left or right hand are determined by view from outside.

## Locks and strike boxes

AL anod Silver (150)	Stainl- Steel satin (750)	Stainl- Steel polished (751)	AL anod Special (199)	AL p-coat Special color (399)
-------------------------------	------------------------------------	---------------------------------------	--------------------------------	-------------------------------------------

Art. No.	Description	€/Piece	€/Piece	€/Piece	€/Piece	€/Piece
<b>Single components</b>						
<b>US 10 Premium corner lock</b>						
Prepared for Euro profile cylinder, single throw, bolt projection 20 mm, with security roses on both sides 14 mm thick, for use with toughened safety glass (TSG). Also prepared for use with laminated safety glass (LSG). Lock insert: - maximum corrosion resistance according to EN 1670, class 4 - maximum corrosion resistance according to DIN 18251 / (EN 12209) class 3**						
42.510	8-19 mm	160,00	160,00	160,00	178,00	178,00
42.517	19-22 mm	181,00	181,00	181,00	209,00	209,00
<b>Please specify exact glass thickness with order.</b>						
Prepared for round cylinder (Swiss profile round cylinder 22 mm) for use with toughened safety glass (TSG). Also prepared for use with laminated safety glass (LSG).						
42.513	8-19 mm	209,00	209,00	209,00	230,00	230,00
42.516	19-22 mm	237,00	237,00	237,00	261,00	261,00
<b>Please specify exact glass thickness with order.</b>						
<b>US 20 Premium center lock</b>						
Prepared for Euro profile cylinder, single throw, bolt projection 20 mm, with security roses 14 mm thick, for use with toughened safety glass (TSG). Also prepared for use with laminated safety glass (LSG). Lock insert: - maximum corrosion resistance according to EN 1670, class 4 - maximum corrosion resistance according to DIN 18251 / (EN 12209) class 3*						
42.520	8-19 mm	160,00	160,00	160,00	178,00	178,00
42.518	19-22 mm	181,00	181,00	181,00	209,00	209,00
<b>Please specify exact glass thickness with order.</b>						
Prepared for round cylinder (Swiss profile round cylinder 22 mm) for use with toughened safety glass (TSG). Also prepared for use with laminated safety glass (LSG).						
42.523	8-19 mm	209,00	209,00	209,00	230,00	230,00
42.519	19-22 mm	237,00	237,00	237,00	261,00	261,00
<b>Please specify exact glass thickness with order.</b>						
<b>For suitable center locks for single-action doors in our MUNDUS design see pages 216 / 217</b>						





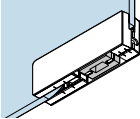
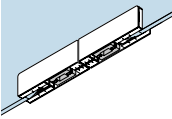
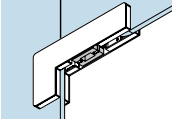
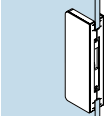



\* Extract from DIN 18251, class 3: Type-test with 50,000 locking bolt operating cycles. Furthermore the lock was tested successfully by a neutral testing institute with 100,000 locking bolt operating cycles.

## Locks and strike boxes

Art. No.	Description	AL anod Silver (150)	Stain- Steel satin (750)	Stain- Steel polished (751)	AL anod Special (199)	AL p-coat Special color (399)
		€/Piece	€/Piece	€/Piece	€/Piece	€/Piece
<b>Single components</b>						
<b>GK 30 Premium single overpanel strike box</b>						
For use with toughened safety glass (TSG). Also prepared for use with laminated safety glass (LSG). With tapped hole at side. Suitable for corner lock US 10.						
	42.530	8–15 mm	160,00	160,00	160,00	178,00
	42.532	15–19 mm	209,00	209,00	209,00	230,00
	42.548	19–22 mm	237,00	237,00	237,00	261,00
<b>GK 20 Premium double overpanel strike box</b>						
Consisting of two GK 30 with threaded connecting bolt. For use with toughened safety glass (TSG). Also prepared for use with laminated safety glass (LSG). Suitable for corner lock US 10.						
	42.526	8–15 mm	322,00	322,00	322,00	355,00
	42.528	15–19 mm	369,00	369,00	369,00	407,00
	42.529	19–22 mm	397,00	397,00	397,00	438,00
<b>GK 40 Premium corner overpanel strike box</b>						
For use with toughened safety glass (TSG). Also prepared for use with laminated safety glass (LSG). Suitable for corner lock US 10.						
	42.540	8–15 mm	181,00	181,00	181,00	199,00
	42.542	15–19 mm	229,00	229,00	229,00	250,00
	42.547	19–22 mm	256,00	256,00	256,00	281,00
<b>GK 40 Premium corner overpanel strike box</b>						
For use with toughened safety glass (TSG). Suitable for corner lock US 10.						
	38.540	8–12 mm	149,00	149,00	149,00	
<b>GK 50 Premium strike box</b>						
For use with toughened safety glass (TSG). Also prepared for use with laminated safety glass (LSG). Suitable for center lock US 20.						
	42.550	8–19 mm	181,00	181,00	181,00	199,00
	42.553	19–22 mm	208,00	208,00	208,00	230,00

Note: Please specify the exact glass thickness when ordering!

Accessories

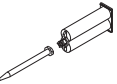
		Base parts (000)	AL anod Silver (150)	Al p-coat Traffic white (350)	Stain-Steel satin (750)	Stain-Steel polished (751)
Art. No.	Description	€/Piece	€/Piece	€/Piece	€/Piece	€/Piece
<b>Single components</b>						
	<b>38.210 MUNDUS PT 21</b> , top pivot with retractable bolt 14 mm Ø	47,50				
	<b>38.211 MUNDUS PT 21</b> , top pivot with retractable bolt 14 mm Ø and coverplate		51,50	51,50	51,50	
	<b>38.240 MUNDUS PT 24</b> , pivot 14 mm Ø, with fixing plate 6 mm, to let into the brickwork		19,50	19,50		
	<b>38.241 MUNDUS PT 24</b> , pivot 14 mm Ø, with fixing plate 3 mm, to screw onto the brickwork		19,50	19,50	19,50	
	<b>38.250 MUNDUS PT 25</b> pivot 14 mm Ø, with plug	7,10				
	<b>01.133 Wall anchor</b> , zinc plated for PT 30	8,60				
	<b>01.134 Threaded rod with wall plug</b> , for PT 30	8,60				
	<b>38.313 MUNDUS fixing plate for PT 30 / GK 30</b>			(stain steel white p-coat) 19,50	19,50	19,50
	<b>07.631 Special adhesive and mixing jet for use with LSG</b> (sufficient for ca. 12 patch fittings) For more LSG components, see page 145	100,00				
	<b>42.951 MUNDUS Premium LSG gaskets</b> , PT 10/20/30	8,60				
	<b>42.952 MUNDUS Premium LSG gaskets</b> , PT 40	10,00				
	<b>42.953 MUNDUS Premium LSG gaskets</b> , PT 60	8,60				
	<b>42.954 MUNDUS Premium LSG gaskets</b> , PT 70	8,60				
	<b>42.955 MUNDUS Premium LSG gaskets</b> , US 10/20 / GK 50	8,60				

Patch fittings and profile systems

# UNIVERSAL



Technical data	
Glass	TSG
Glass thickness	8, 10, 12, 13, 15, 19 mm
Max. door weight	110 kg
Lock application	SG locks (non-lockable, profile cylinder, round cylinder), Patch locks
Applications	24 Standard types for toughened glass assemblies
Material	Aluminium, brass, stainless steel
Finishes	Anodised and RAL colors, brass, stainless steel
Specials	Suitable for outdoor assemblies

24 Standard types for toughened glass assemblies

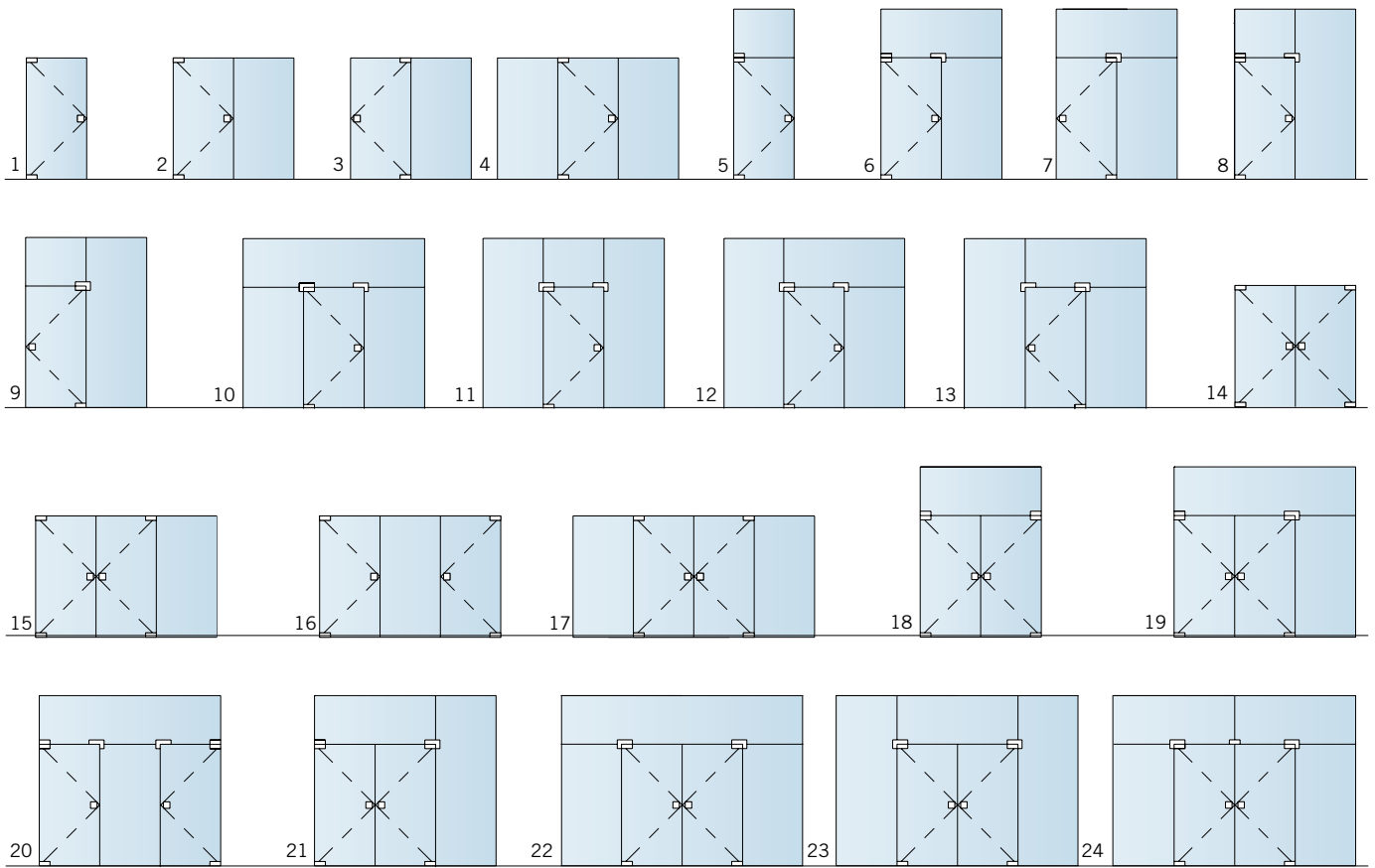

Example view for UNIVERSAL

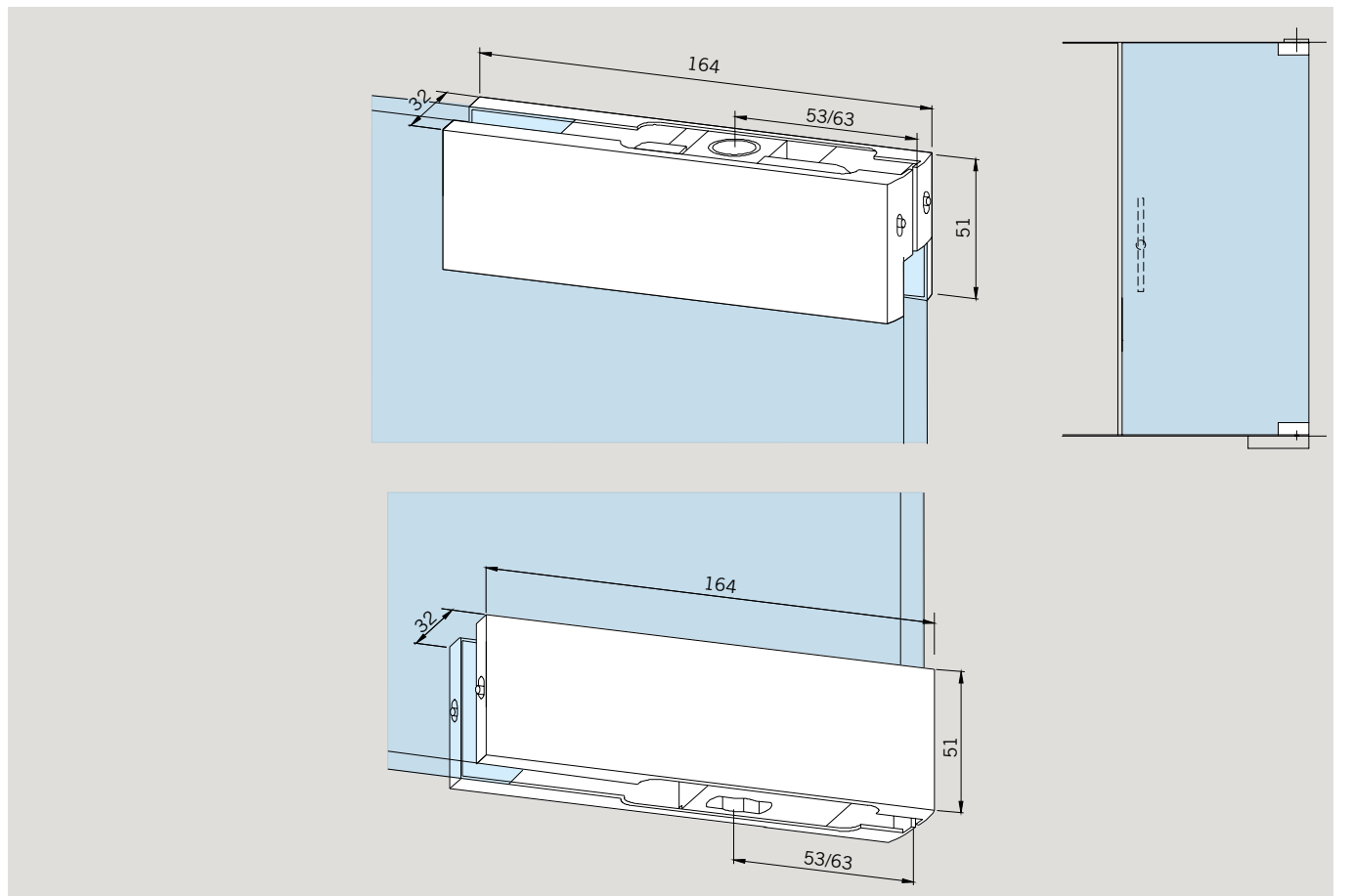

Glass assemblies

**For 10 mm glass thickness**

Base parts (000)    AL anod EV1 (101)    Brass polished (503)    Stainl-Steel satin (700)    Stainl-Steel polished (701)    AL anod Special (199)    AL p-coat Special color (399)





Art. No.	Description	€ / Piece	€ / Piece	€ / Piece	€ / Piece	€ / Piece	€ / Piece
<b>Patch / connecting fittings, locks, and strike-boxes for double action doors</b>							
	<b>03.100 PT 10 UNIVERSAL bottom patch fitting</b>	69,50	98,00	95,50	106,00	96,00	96,00
	<b>01.137 Floor pivot bearing for damp environments, with insert for UNIVERSAL for mounting onto floor surface, max. door weight 80 kg</b>	62,50					
	<b>03.206 US 10 UNIVERSAL corner lock</b>	109,00	155,00	155,00	174,00	153,00	153,00
	<b>03.110 PT 20 UNIVERSAL top patch fitting</b>	68,00	96,50	95,00	104,00	94,00	94,00
	<b>03.112 PT 22 UNIVERSAL top patch fitting for dormakaba RTS transom closer</b>	106,00		132,00	146,00	148,00	148,00
	<b>03.114 PT 29 UNIVERSAL top patch fitting with fixing angle</b>	129,00	182,00			182,00	182,00
	<b>03.215 US 20 UNIVERSAL centre lock</b>	114,00	164,00	164,00	182,00	162,00	162,00
	<b>03.224 GK 50 UNIVERSAL strike-box</b>	113,00	163,00	163,00	181,00	159,00	159,00
	<b>03.120 PT 30 UNIVERSAL overpanel patch fitting with pivot Ø 15 mm</b>	70,50	96,50	96,50	107,00	99,50	99,50
	<b>03.420 PT 30 UNIVERSAL overpanel patch fitting with stop insert</b>	70,00		96,50		99,50	99,50
	<b>03.421 PT 30 UNIVERSAL overpanel patch fitting with blank insert</b>	68,50		95,50		96,50	96,50
	<b>03.128 Fixing plate for PT 30</b>	11,00	35,50			15,50	15,50
	<b>01.133 Wall anchor, zinc plated for PT 30</b>	8,60					
	<b>01.134 Threaded rod with wall plug, for PT 30</b>	8,60					

Patch fittings and profile systems



**For 10 mm glass thickness**







AL anod EV1 (101)    Brass polished (503)    Stainl-Steel satin (700)    AL anod Special (199)    AL p-coat Special color (399)

Art. No.	Description	DIN	€/Piece	€/Piece	€/Piece	€/Piece	€/Piece
	<b>03.230 GK 30 UNIVERSAL overpanel strike-box</b>		113,00		163,00	159,00	159,00
	<b>03.245 GK 20 UNIVERSAL double overpanel strike-box, consisting of 2 x GK 30 with threaded rod</b>		182,00		277,00	258,00	258,00
	<b>03.140 PT 40 UNIVERSAL patch fitting for overpanel and sidelight, with pivot insert Ø 15 mm</b>		92,50	134,00	134,00	129,00	129,00
	<b>03.440 PT 40 UNIVERSAL patch fitting for overpanel and sidelight, with stop insert</b>		92,50		134,00	129,00	129,00
	<b>03.441 PT 40 UNIVERSAL patch fitting for overpanel and sidelight, with blank insert</b>		91,00		132,00	128,00	128,00
	<b>03.250 GK 40 UNIVERSAL corner overpanel strike-box</b>		136,00		193,00	193,00	193,00
	<b>03.162 PT 41 UNIVERSAL patch fitting for overpanel and sidelight with fin on one side</b>	LH	242,00		309,00	341,00	341,00
	<b>03.163 do.</b>	RH	242,00		309,00	341,00	341,00
	<b>03.262 do. with stop insert</b>	LH	242,00		309,00	341,00	341,00
	<b>03.263 do.</b>	RH	242,00		309,00	341,00	341,00
	<b>03.150 PT 60/61 UNIVERSAL connector for overpanel and sidelight (also for 12 mm glass thickness) with inserts (1 x stop, 2 x blank)</b>		74,50	121,00	121,00	105,00	105,00
	<b>01.150 PT 70 UNIVERSAL overpanel connector (also for 12 mm glass thickness) with inserts (2 x stop, 2 x blank)</b>		68,50		93,50	102,00	102,00

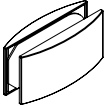
Patch fittings and profile systems

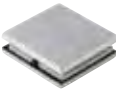

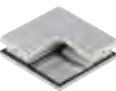
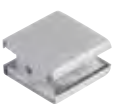

## For 10 mm glass thickness

AL anod EV1 (101)	Brass polished (503)	Stain- Steel satin (700)	AL anod Special (199)	AL p-coat Special color (399)
----------------------------	----------------------------	-----------------------------------	--------------------------------	-------------------------------------------

Art. No.	Description	€/Piece	€/Piece	€/Piece	€/Piece	€/Piece
	12.536 Overpanel-sidelight connector	(114) 44,50		(113) 53,50	57,00	57,00
	01.161 PT 71 UNIVERSAL overpanel connector, with fin on one side	267,00		312,00	371,00	371,00
	01.153 Sidelight connector with fixing plate (also for 12 mm glass)	100,00	127,00	125,00	140,00	140,00
	03.170 PT 80 UNIVERSAL connector	64,50		96,50	90,50	90,50
	03.175 PT 81 UNIVERSAL connector with fin on one side	282,00		339,00	395,00	395,00
	03.173 PT 62 UNIVERSAL connector with stop	64,50		96,50	90,50	90,50
	07.021 PT 90 UNIVERSAL screw-on fitting	24,50	50,50	50,50	39,50	39,50
	07.023 PT 91 UNIVERSAL corner fitting	36,50	59,00	59,00	53,50	53,50

**For 10 mm glass thickness**

AL anod EV1 (101)    Stainl-Steel satin (700)    AL anod Special (199)    AL p-coat Special color (399)

Art. No.	Description	DIN	€/Piece	€/Piece	€/Piece	€/Piece
	<b>03.161</b> PT 41 UNIVERSAL patch fitting for overpanel and sidelight, with fin fitting on both sides		439,00	536,00	617,00	617,00
	<b>03.164</b> PT 42 UNIVERSAL overpanel patch with angled connector, with 90° angle	LH	545,00	634,00	765,00	765,00
	<b>03.165</b> do.	RH	545,00	634,00	765,00	765,00
	<b>03.160</b> PT 51 UNIVERSAL patch fitting for double overpanel with fin fitting on one side		442,00	525,00	618,00	618,00
	<b>03.171</b> PT 80 UNIVERSAL connector with 90° angle		330,00	385,00	462,00	462,00
	<b>03.470</b> PT 80 UNIVERSAL connector, shortened, with angle 90°		219,00	277,00	307,00	307,00
	<b>03.172</b> PT 80 UNIVERSAL connector with 135° angle		330,00	385,00	462,00	462,00

Patch fittings and profile systems

## For 10 mm glass thickness

Base parts (000)	AL anod EV1 (101)	Stain-Steel satin (700)	Stain-Steel polished (701)	AL anod Special (199)	AL p-coat Special color (399)
------------------	-------------------	-------------------------	----------------------------	-----------------------	-------------------------------

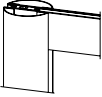
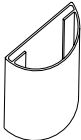
Art. No.	Description	€/Piece	€/Piece	€/Piece	€/Piece	€/Piece	€/Piece
<b>Single components</b>							
<b>Pinch free with pivot point 65 mm</b>							
	<b>03.380 Round aluminium profile for pinch free doors</b> with 65 mm pivot point, consisting of 2 pieces, optionally prepared for: – UNIVERSAL fittings – 76.5 mm door rails – 100 mm door rails Please indicate: – Panel height (max. 3000 mm, higher dim. on request) – Required preparation of the profile for top and bottom fittings		<b>367,00</b>		<b>514,00</b>	<b>514,00</b>	
	<b>Aluminium round profile</b> for pinch free doors with 65 mm pivot point, consisting of 2 pieces, (not prepared)		<b>597,00</b>		<b>837,00</b>	<b>837,00</b>	
	<b>03.381</b> each 6000 mm stock length						
	<b>03.382</b> each 3000 mm stock length		<b>306,00</b>		<b>465,00</b>	<b>465,00</b>	
			€/m		€/m	€/m	
	<b>03.383</b> each max. 2800 mm fixed length		<b>114,00</b>		<b>162,00</b>	<b>162,00</b>	
	<b>Acrylic profile, clear</b> completely clamp free		<b>70,00</b>				
	<b>01.230</b> in stock length 2250 mm		€/m				
	<b>01.231</b> in fixed length upto 4500 mm		<b>38,50</b>				

## For 13, 15 and 19 mm glass thickness

Art. No.	Description	AL	Stainl-	AL	AL
		anod EV1 (101)	Steel satin (700)	anod Special (199)	p-coat Special color (399)
		€/Piece	€/Piece	€/Piece	€/Piece
<b>Patch / Connection fittings for 13, 15 and 19 mm TSG (please indicate glass thickness with the order)</b>					
03.280	PT 10 UNIVERSAL bottom patch fitting	81,00	108,00	116,00	116,00
03.281	PT 20 UNIVERSAL top patch fitting	78,00	107,00	113,00	113,00
03.282	PT 30 UNIVERSAL overpanel patch fitting with pivot insert Ø 15 mm	83,00	109,00	118,00	118,00
03.482	PT 30 UNIVERSAL overpanel patch fitting with stop insert	83,00	109,00	118,00	118,00
03.484	PT 30 UNIVERSAL overpanel patch fitting with blank insert	81,50	107,00	116,00	116,00
03.283	PT 40 UNIVERSAL patch fitting for overpanel and sidelight with pivot insert Ø 15 mm	104,00	146,00	158,00	158,00
03.483	PT 40 UNIVERSAL patch fitting for overpanel and sidelight with stop insert	104,00	146,00	158,00	158,00
03.485	PT 40 UNIVERSAL patch fitting for overpanel and sidelight with blank insert	103,00	145,00	156,00	156,00
03.452	PT 60/61 UNIVERSAL patch fitting for connection of overpanel and sidelight with inserts (1 x stop, 2 x blank)	78,00	127,00	109,00	109,00
01.158	PT 70 UNIVERSAL patch fitting for connection of overpanel and sidelight with inserts (2 x stop, 2 x blank)	71,00	93,50	106,00	106,00
03.472	PT 80 UNIVERSAL connector	68,00	102,00	94,00	94,00
07.210	PT 90 UNIVERSAL screw on fitting	27,00	53,50	42,00	42,00
07.211	PT 91 UNIVERSAL corner fitting	39,50	61,00	55,50	55,50
03.285	US 10 UNIVERSAL corner lock	120,00	168,00	166,00	166,00
03.295	GK 30 UNIVERSAL overpanel strike box	127,00	171,00	174,00	174,00
03.286	US 20 UNIVERSAL centre lock	126,00	175,00	173,00	173,00
03.296	GK 50 UNIVERSAL strike box	125,00	174,00	172,00	172,00



## Gaskets

Base  
parts  
(000)

Art. No.	Description	€/Piece
<b>Gasket set for 12 mm glass thickness</b>		
03.900	for PT 10 / 20 / 22 / 29 / 30 und GK 30	3,70
03.901	for US 10 / 20 und GK 50	3,60
03.902	for PT 40 / 41 / 42 and GK 40 / 41 / 42	7,40
03.903	for PT 51	5,40
03.904	for PT 60 / 61 / 62	7,20
03.905	for PT 70 / 71	5,40
03.906	for PT 80 / 81	5,40
03.907	für PT 80 semi-high	5,40
03.908	for PT 90 / 91	3,40
03.909	for sidelight connector 01.153	6,20
<b>Gasket set for 8 mm glass thickness</b>		
03.920	for PT 10 / 20 / 22 / 29 / 30 ud GK 30	3,70
03.921	for US 10 / 20 and GK 50	3,40
03.922	for PT 40 / 41 / 42 and GK 40 / 41 / 42	7,40
03.923	for PT 51	5,40
03.924	for PT 60 / 61 / 62	7,20
03.925	for PT 70 / 71	5,40
03.926	for PT 80 / 81	5,40
03.927	for PT 80 semi-high	5,40
03.928	for PT 90 / 91	3,40
03.929	for sidelight connector 01.153	6,20

## For 10 and 12 mm glass thickness

AL anod EV1 (101)	Stain- Steel satin (700)	Stain- Steel polished (701)	AL anod Special (199)	AL p-coat Special color (399)
----------------------------	-----------------------------------	--------------------------------------	--------------------------------	-------------------------------------------

Art. No.	Description	€/Piece	€/Piece	€/Piece	€/Piece	€/Piece
	<b>03.147 UNIVERSAL MOTION NG33,</b> bottom patch fitting with integrated hydraulic door closing function and 90 degrees hold open, with floor bearing complete, for 10 mm and 12 mm glass thickness	268,00	275,00	292,00	316,00	316,00
	<b>03.148 UNIVERSAL MOTION NG33,</b> bottom patch fitting with integrated hydraulic door closing function, without hold open, with floor bearing complete, for 10 mm and 12 mm glass thickness	268,00	275,00	292,00	316,00	316,00

# UNIVERSAL light



Technical data	
Glass	TSG
Glass thickness	10, 12 mm
Max. door weight / door width	100 kg / 1100 mm
Lock application	Euro profile cylinder
Applications	Single/double leaf, sidelights, overpanels, toughened glass assembly
Material	Stainless steel
Finishes	Satin stainless steel, polished stainless steel
Specials	Tested acc. to EN 1154 with 200.000 operating cycles



## Fittings for toughened glass assemblies

**184** Patch fitting MUNDUS Comfort

**190** Patch fitting MUNDUS Premium

**198** Patch fitting UNIVERSAL

**207** Patch fitting UNIVERSAL Motion NG33

**208** Patch fitting UNIVERSAL light

**210** Single action door fitting BEYOND

**216** EA-Patch fittings for single action doors

**222** Door rails TP/TA EASY Safe

**234** Door rails TP/TA 76.5

**242** Single action door fitting MANET

**250** Wall connecting profiles

**256** Frame systems MR 22 & MR 28

**260** Centre and corner locks SG, strike boxes

### General accessories for toughened glass assemblies



**270** Clamping fitting, U-profile

**271** Pivot bearing, floor bearing, strike plates,  
floor sockets, profile cylinders

## Single components

Stainl-  
Steel  
satin  
(700)

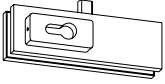
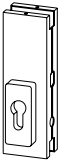
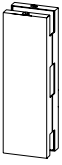
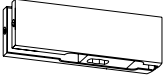
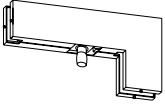
Stainl-  
Steel  
polished  
(701)

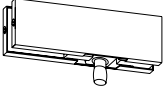
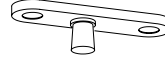
	Art. No.	Description	€/Piece	€/Piece
	03.608	<b>UNIVERSAL Light US 10</b> corner lock	54,50	54,50
	03.617	<b>UNIVERSAL Light US 20</b> centre lock	54,50	54,50
	03.526	<b>UNIVERSAL Light GK 50</b> strike box	27,50	27,50
	03.502	<b>UNIVERSAL Light PT 10</b> bottom patch fitting	27,50	27,50
	03.542	<b>UNIVERSAL Light PT 40</b> patch fitting for overpanel with pivot insert Ø 15 mm	50,50	50,50
	03.512	<b>UNIVERSAL Light PT 20</b> top patch fitting	26,50	26,50
	03.522	<b>UNIVERSAL Light PT 30</b> overpanel patch fitting with pivot insert, Ø 15 mm	27,50	27,50
	03.623	<b>UNIVERSAL Light PT 24</b> Pivot with fixing plate, material thickness 3 mm, to screw on the brick work	10,50	10,50

## Notes

# BEYOND



Technical data	
Glass	TSG
Glass thickness	10 and 12 mm
Max. door weight	80 kg
Lock application	SG
Applications	1-/2 panels, sidelight, overpanel, glass assembly
Material	Aluminium
Finishes	Anodised colors
Specials	Absolutely pinch free with continuous pivoting rod, Patented fitting system

## Fittings for toughened glass assemblies

- 184** Patch fitting MUNDUS Comfort
- 190** Patch fitting MUNDUS Premium
- 198** Patch fitting UNIVERSAL
- 207** Patch fitting UNIVERSAL Motion NG33
- 208** Patch fitting UNIVERSAL light
- 210** Single action door fitting BEYOND
- 216** EA-Patch fittings for single action doors
- 222** Door rails TP/TA EASY Safe
- 234** Door rails TP/TA 76.5
- 242** Single action door fitting MANET
- 250** Wall connecting profiles
- 256** Frame systems MR 22 & MR 28
- 260** Centre and corner locks SG, strike boxes



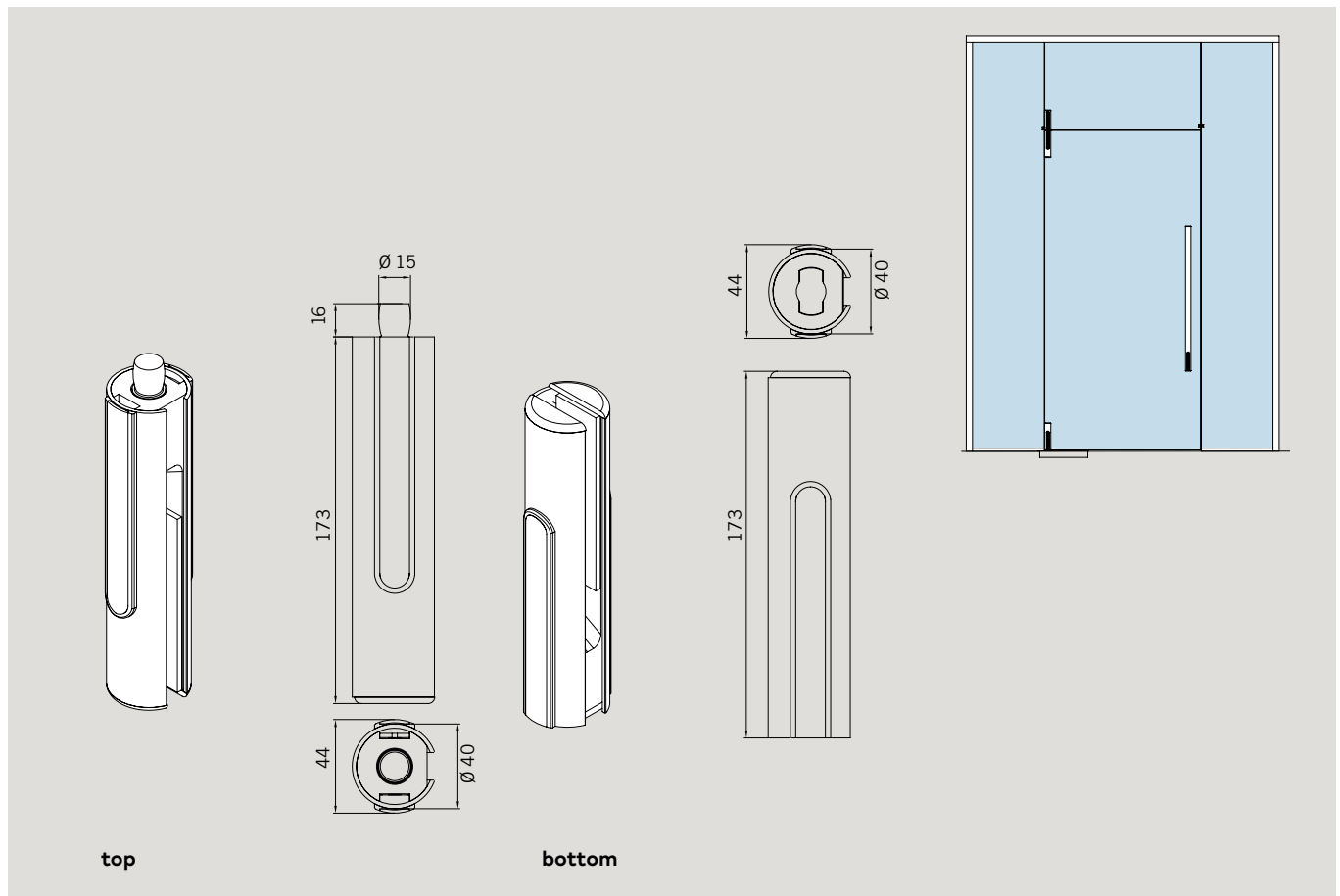

### General accessories for toughened glass assemblies

- 270** Clamping fitting, U-profile
- 271** Pivot bearing, floor bearing, strike plates, floor sockets, profile cylinders

### Example view for BEYOND



## For 10 and 12 mm glass thickness

Art. No.	Description	Base parts (000)	AL anod EV1 Deco (114)	AL anod sim Stainl-Steel pol matte (107)
		€/Piece	€/Piece	€/Piece
<b>Complete sets</b>				
<b>Pivoting fitting set, short type</b>				
consisting of:				
1 top pivot fitting with pivot Ø 15 mm				
1 bottom pivot fitting with insert for dormakaba floor spring spindle or round pivot				
	<b>30.100</b>	for 10 mm glass thickness	<b>312,00</b>	<b>381,00</b>
	<b>30.101</b>	for 12 mm glass thickness	<b>312,00</b>	<b>381,00</b>
<b>Pivoting fitting, long type,</b>				
with pivot Ø 15 mm at top and insert for dormakaba floor spring spindle or round pivot at bottom				
	<b>30.110</b>	for 10 mm glass thickness (please indicate exact door height = glass measurement with order)	<b>353,00</b>	<b>427,00</b>
	<b>30.111</b>	for 12 mm glass thickness (please indicate exact door height = glass measurement with order)	<b>353,00</b>	<b>427,00</b>
<b>Single components</b>				
<b>BEYOND overpanel fitting, wall connector,</b>				
with plastic socket for top pivot				
	<b>30.120</b>	for 10 mm glass thickness	<b>148,00</b>	<b>181,00</b>
	<b>30.121</b>	for 12 mm glass thickness	<b>155,00</b>	<b>187,00</b>
<b>BEYOND overpanel fitting, glass connector,</b>				
with plastic socket for top pivot				
	<b>30.130</b>	for 10 mm glass thickness	<b>148,00</b>	<b>181,00</b>
	<b>30.131</b>	for 12 mm glass thickness	<b>155,00</b>	<b>187,00</b>
	<b>30.320</b>	<b>BEYOND overpanel fitting, glass connector,</b> with plastic socket for top pivot for 10 mm and 12 mm glass thickness	<b>21,50</b>	
<b>Anti-vibration device</b>				
	<b>30.034</b>	for 10 mm glass thickness	<b>11,00</b>	
	<b>30.035</b>	for 12 mm glass thickness	<b>11,00</b>	

## Notes

# EA - Patch fittings for single action doors



Technical data	
Glass	TSG
Glass thickness	8, 10, 12 mm
Max. door weight	100 kg
Applications	1-/2 panels, sidelight, overpanel, glass assembly
Material	Aluminium
Finishes	Anodised- and RAL-Colors (coated)
Specials	Door opening up to 180°, Applicable for semi-circular arch doors, Suitable for outdoor assemblies.



## Fittings for toughened glass assemblies

**184** Patch fitting MUNDUS Comfort

**190** Patch fitting MUNDUS Premium

**198** Patch fitting UNIVERSAL

**207** Patch fitting UNIVERSAL Motion NG33

**208** Patch fitting UNIVERSAL light

**210** Single action door fitting BEYOND

**216** EA-Patch fittings for single action doors

**222** Door rails TP/TA EASY Safe

**234** Door rails TP/TA 76.5

**242** Single action door fitting MANET

**250** Wall connecting profiles

**256** Frame systems MR 22 & MR 28

**260** Centre and corner locks SG, strike boxes

### General accessories for toughened glass assemblies





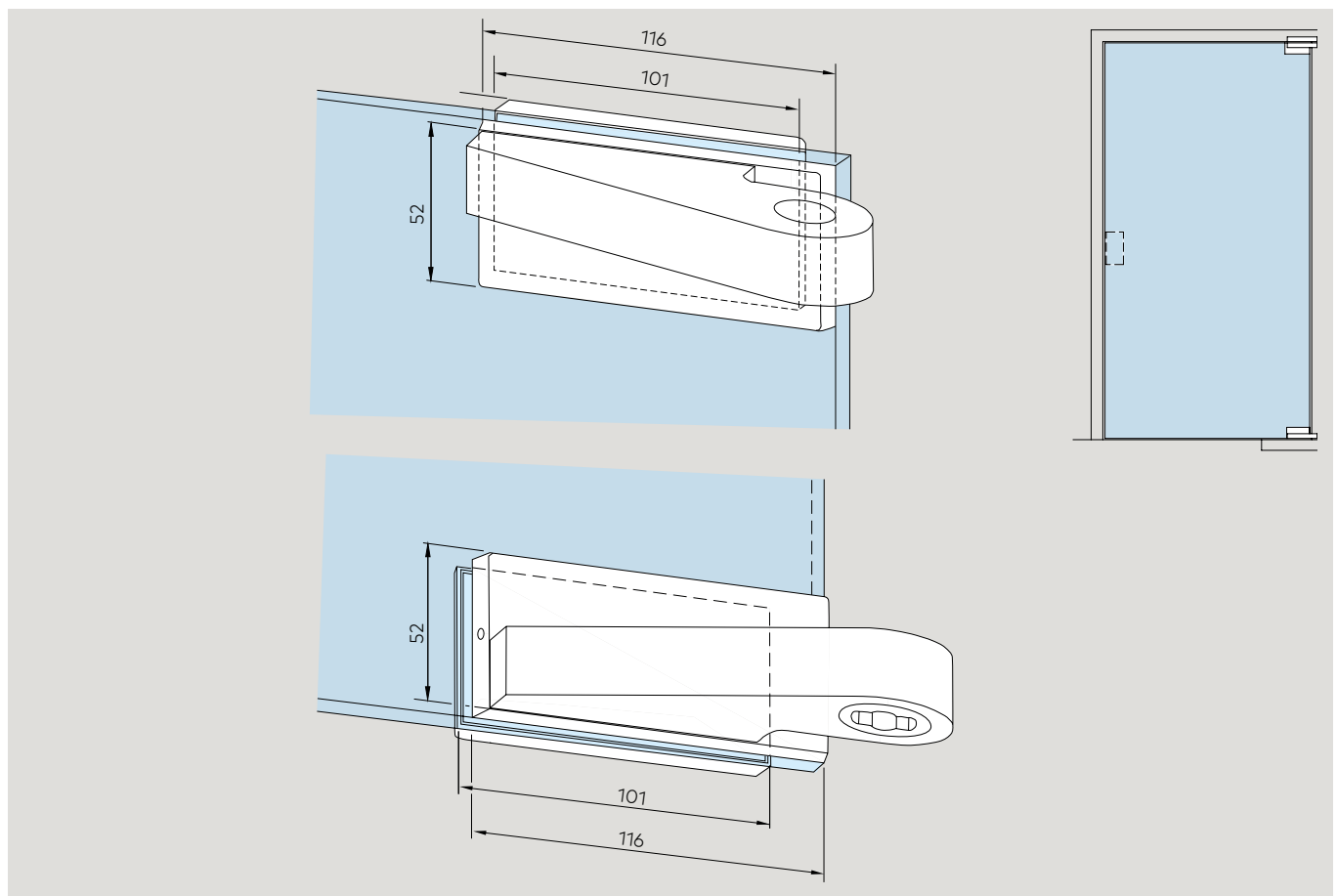

**270** Clamping fitting, U-profile

**271** Pivot bearing, floor bearing, strike plates, floor sockets, profile cylinders







### Example view for EA - Patchfitting for single action doors



## Complete for 10 and 12 mm glass thickness, door strap 36 mm

Art. No.	Description	DIN	AL	AL	AL	AL	
			anod EV1 (101)	anod sim Stainl- Steel pol matte (107)	anod Special (199)	p-coat Special color (399)	€/Piece
<b>Patch fitting for single action doors without rebate, for 10 mm and 12 mm glass thickness</b>							
	<b>02.100</b> Bottom patch fitting	LH	112,00	159,00	159,00	159,00	
	<b>02.101</b> do.	RH	112,00	159,00	159,00	159,00	
	<b>02.110</b> Top patch fitting	LH	108,00	155,00	155,00	155,00	
	<b>02.111</b> do.	RH	108,00	155,00	155,00	155,00	
	<b>02.120</b> Overpanel patch fitting	LH	120,00	173,00	173,00	173,00	
	<b>02.121</b> do.	RH	120,00	173,00	173,00	173,00	
	<b>02.140</b> Patch fitting for overpanel and sidelight	LH	141,00	203,00	203,00	203,00	
	<b>02.141</b> do.	RH	141,00	203,00	203,00	203,00	
	<b>02.200</b> Top fitting with pivot for sidelight	LH	236,00	338,00	338,00	338,00	
	<b>02.201</b> do.	RH	236,00	338,00	338,00	338,00	
	<b>02.202</b> Top fitting with pivot for wall fixing	LH	236,00	338,00	338,00	338,00	
	<b>02.203</b> do.	RH	236,00	338,00	338,00	338,00	
	<b>02.204</b> Top fitting with pivot for frame fixing	LH	236,00	338,00	338,00	338,00	
	<b>02.205</b> do.	RH	236,00	338,00	338,00	338,00	

## Complete for 10 and 12 mm glass thickness, door strap 42 mm

Art. No.	Description	DIN	AL	AL	AL	AL
			anod EV1 (101)	anod sim Stainl-Steel pol matte (107)	anod Special (199)	p-coat Special color (399)
			€/Piece	€/Piece	€/Piece	€/Piece
<b>Patch fittings for single action doors with 24 mm rebate depth, for 10 mm glass thickness</b>						
	<b>02.102</b> Bottom patch fitting with counter-plate shortened at side	LH	112,00	159,00	159,00	159,00
	<b>02.103</b> do.	RH	112,00	159,00	159,00	159,00
	<b>02.104</b> Bottom patch fitting with counter-plate shortened at bottom and side	LH	112,00	159,00	159,00	159,00
	<b>02.105</b> do.	RH	112,00	159,00	159,00	159,00
	<b>02.112</b> Top patch fitting with counter-plate shortened at side	LH	108,00	155,00	155,00	155,00
	<b>02.113</b> do.	RH	108,00	155,00	155,00	155,00
	<b>02.114</b> Top patch fitting with counter-plate shortened at top and side	LH	108,00	155,00	155,00	155,00
	<b>02.115</b> do.	RH	108,00	155,00	155,00	155,00
	<b>02.122</b> Overpanel patch fitting with counter-plate shortened at side	LH	108,00	155,00	155,00	155,00
	<b>02.123</b> do.	RH	108,00	155,00	155,00	155,00
	<b>02.206</b> Top fitting with pivot for frame fixing, counter-plate shortened at side	LH	236,00	338,00	338,00	338,00
	<b>02.207</b> do.	RH	236,00	338,00	338,00	338,00





Patch fittings and profile systems

## Complete for 10 mm glass thickness, door strap 33 – 41 bzw. 43 – 58 mm

Art. No.	Description	DIN	AL	AL	AL	AL	
			anod EV1 (101)	anod sim Stainl- Steel pol matte (107)	anod Special (199)	p-coat Special color (399)	€/Piece
<b>Patch fittings for single action doors with individual rebate depth (15 – 23 resp. 25 – 40 mm) for 10 mm glass thickness</b>							
	<b>02.106</b> Bottom patch fitting with counter-plate shortened at side	LH	127,00	183,00	183,00	183,00	
	<b>02.107</b> do.	RH	127,00	183,00	183,00	183,00	
	<b>02.108</b> Bottom patch fitting with counter-plate shortened at side	LH	127,00	183,00	183,00	183,00	
	<b>02.109</b> do.	RH	127,00	183,00	183,00	183,00	
	<b>02.116</b> Top patch fitting with counter-plate shortened at side	LH	123,00	178,00	178,00	178,00	
	<b>02.117</b> do.	RH	123,00	178,00	178,00	178,00	
	<b>02.118</b> Top patch fitting with counter-plate shortened at top and side	LH	123,00	178,00	178,00	178,00	
	<b>02.119</b> do.	RH	123,00	178,00	178,00	178,00	
	<b>02.124</b> Overpanel with counter-plate shortened at side	LH	131,00	191,00	191,00	191,00	
	<b>02.125</b> do.	RH	131,00	191,00	191,00	191,00	
	<b>02.208</b> Top fitting with pivot for frame fixing, counter-plate shortened at side	LH	263,00	424,00	424,00	424,00	
	<b>02.209</b> do.	RH	263,00	424,00	424,00	424,00	

Please specify glass thickness when ordering.

## Door strap 36 mm

Art. No.	Description	DIN	AL	AL	Stainl-	AL	AL	
			anod EV1 (101)	anod sim Stainl- Steel pol matte (107)	Steel satin (700)	anod Special (199)	p-coat Special color (399)	€/Piece
<b>Frame top centres</b>								
	<b>02.150</b> Frame top centre with fixing block		63,50	92,00		92,50	92,50	
	<b>02.151</b> Frame top centre with angle bracket		63,50	92,00		92,50	92,50	
	<b>02.152</b> Frame top centre with special wedge screw fixings	LH	63,50	92,00		92,50	92,50	
	<b>02.153</b> do.	RH	63,50	92,00		92,50	92,50	
	<b>02.340</b> Top centre frame AT 21	LH				40,00		
	<b>02.341</b> Top centre frame AT 21	RH				40,00		

# Door rails TP/TA EASY Safe



Technical data	
Glass	TSG, STG (Semi Tempered Glass), LSG made of 2 x TSG
Glass thickness	10 – 19 mm
Max. door weight	200 kg
Lock application	Profile cylinder, round cylinder
Applications	1 or 2 panel double-action and single-action doors, fixed sidelights, toughened glass assemblies
Material	Aluminium, stainless steel
Finishes	AL anodised and powder coated RAL colors, stainless steel
Specials	Suitable for combination with patch fittings

## Fittings for toughened glass assemblies

**184** Patch fitting MUNDUS Comfort

**190** Patch fitting MUNDUS Premium

**198** Patch fitting UNIVERSAL

**207** Patch fitting UNIVERSAL Motion NG33

**208** Patch fitting UNIVERSAL light

**210** Single action door fitting BEYOND

**216** EA-Patch fittings for single action doors

**222** Door rails TP/TA EASY Safe

**234** Door rails TP/TA 76.5

**242** Single action door fitting MANET

**250** Wall connecting profiles

**256** Frame systems MR 22 & MR 28

**260** Centre and corner locks SG, strike boxes

### General accessories for toughened glass assemblies

**270** Clamping fitting, U-profile

**271** Pivot bearing, floor bearing, strike plates, floor sockets, profile cylinders

### Example view for Door rails

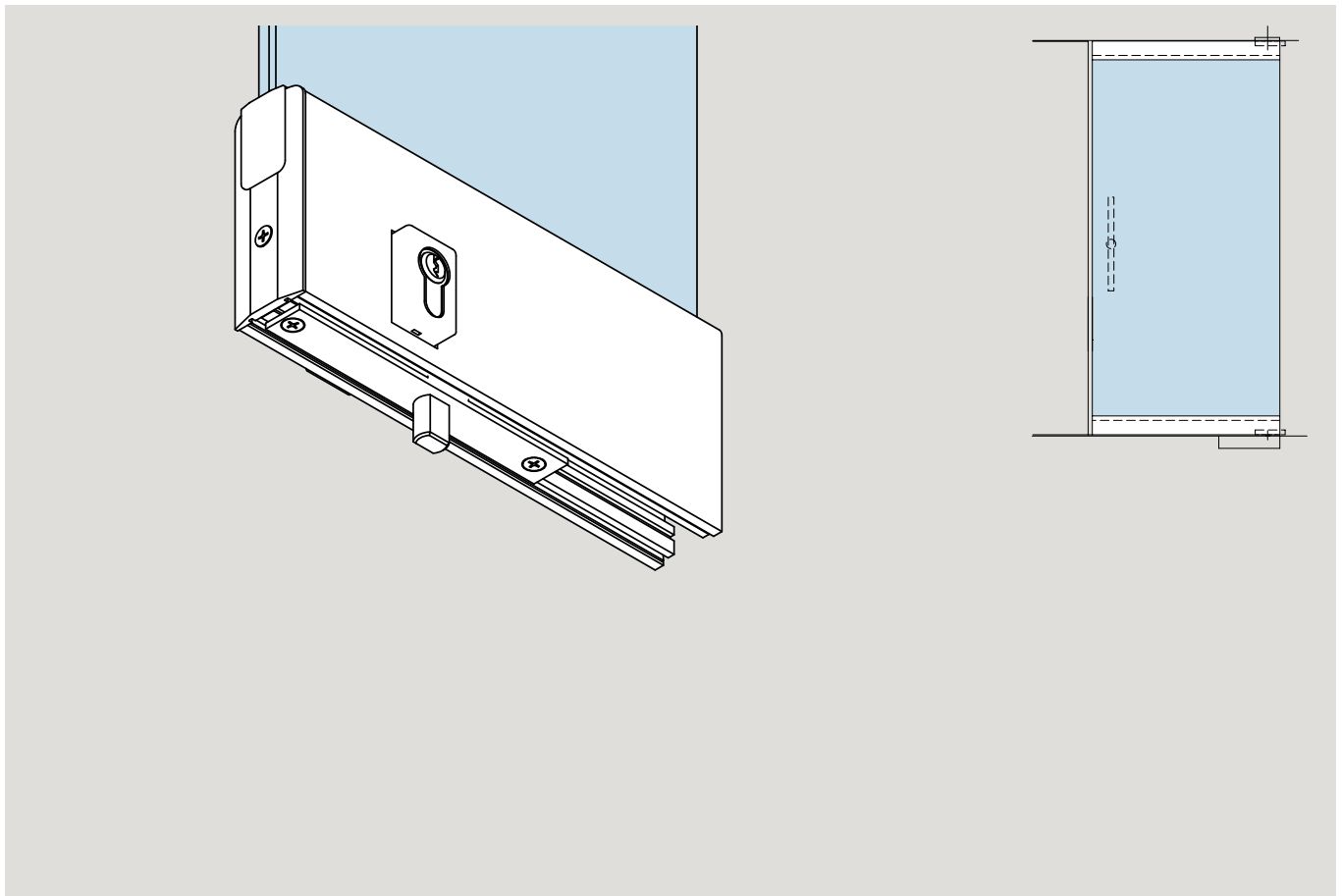

## 105 mm high, for double action doors up to 1200 mm door width TP/TA EASY Safe, complete for 10 mm glass thickness as standard

Art. No. DIN LH	Art. No. DIN RH	Description	AL mill finish (100)	AL anod Silver (150)	AL anod sim. Stain- Steel satin (157)	Al p-coat Traffic white (350)	AL p-coat sim. Anod EV1 (318)	AL p-coat Special color weather resist. *** (398)	Stain- Steel satin (700)	AL anod Special (199)	AL p-coat Special color (399)
			€/Piece	€/Piece	€/Piece	€/Piece	€/Piece	€/Piece	€/Piece	€/Piece	€/Piece
<b>Door rail, 105 mm high, for double action doors, without lock. Please indicate exact door width!</b>											
40.702	40.802	without lock, x = 55/65 top	309,00	332,00	368,00	332,00	416,00	416,00	465,00	416,00	416,00
40.701	40.801	do. bottom	309,00	332,00	368,00	332,00	416,00	416,00	465,00	416,00	416,00
40.704	40.804	without lock, with pin, x = 20 top	473,00	401,00	435,00	401,00	508,00	508,00	557,00	508,00	508,00
40.703	40.803	do. bottom	473,00	401,00	435,00	401,00	508,00	508,00	557,00	508,00	508,00
40.707	40.807	without lock bottom prepared for floor bearing, x = 20	376,00	399,00	398,00	397,00	477,00	477,00	526,00	477,00	477,00
40.706	40.806	without lock, top prepared for dormakaba RTS, x = 65	383,00	371,00	401,00	406,00	479,00	479,00	532,00	479,00	479,00
<b>Door rail, 105 mm high, for double action doors, with floor locking/top locking profile cylinder bolt lock Please indicate exact door width!</b>											
40.712	40.812	with bolt lock, x = 55/65 top	503,00	534,00	573,00	534,00	618,00	618,00	677,00	618,00	618,00
40.711	40.811	do. bottom	503,00	534,00	573,00	534,00	618,00	618,00	677,00	618,00	618,00
40.714	40.814	with bolt lock, with pin,, x = 20 top	597,00	626,00	666,00	626,00	698,00	698,00	757,00	698,00	698,00
40.713	40.813	do. bottom	597,00	626,00	666,00	626,00	698,00	698,00	757,00	698,00	698,00
40.717	40.817	with bolt lock, bottom prepared for floor bearing, x = 20	564,00	594,00	635,00	600,00	668,00	668,00	729,00	668,00	668,00
40.716	40.816	with bolt lock, top prepared for dormakaba RTS, x = 65	571,00	600,00	642,00	600,00	669,00	669,00	735,00	669,00	669,00

Please indicate exact glass thickness with order.  
The prices given are valid for TSG in 10 mm glass thickness.  
For surcharges for other glass thicknesses or for LSG please see page 296.

\*\*\* Preparation times for surface 398 on request

2 5 10 15 20 25



**105 mm high, for double action doors up to 1200 mm door width  
TP/TA EASY Safe, complete for 10 mm glass thickness as standard**

Art. No. DIN LH	Art. No. DIN RH	Description	AL mill finish (100)	AL anod Silver (150)	AL anod sim. Stain- Steel satin (157)	Al p-coat Traffic white (350)	AL p-coat sim. Anod EV1 (318)	AL p-coat Special color weather resist. (398) ***	Stain- Steel satin (700)	AL anod Special (199)	AL p-coat Special color (399)
			€/Piece	€/Piece	€/Piece	€/Piece	€/Piece	€/Piece	€/Piece	€/Piece	€/Piece
<p><b>Door rail, 105 mm high, for double action doors, with side locking profile cylinder bolt lock Please indicate exact door width!</b></p>											
40.722	40.822	with bolt lock,, x = 55/65 top	588,00	622,00	657,00	622,00	736,00	736,00	790,00	736,00	736,00
40.721	40.821	do. bottom	588,00	622,00	657,00	622,00	736,00	736,00	790,00	736,00	736,00
40.724	40.824	with bolt lock, with pin, x = 20 top	687,00	719,00	767,00	719,00	817,00	817,00	886,00	817,00	817,00
40.723	40.823	do. bottom	687,00	719,00	767,00	719,00	817,00	817,00	886,00	817,00	817,00
40.727	40.827	with bolt lock, bottom prepared for floor bearing, x = 20	646,00	680,00	726,00	680,00	813,00	813,00	855,00	813,00	813,00
40.726	40.826	with bolt lock, top prepared for dormakaba RTS, x = 65	665,00	690,00	735,00	701,00	820,00	820,00	861,00	820,00	820,00
<p><b>Door rails, 105 mm high, for double action doors, with/for electric strike release Please indicate exact door width</b></p>											
40.792	40.794	with profile cylinder latch lock top at side for electric strike release and floor/top locking bolt lock, x = 55/65	843,00	873,00	921,00	873,00	957,00	957,00	1037,00	957,00	957,00
40.791	40.793	do. bottom	843,00	873,00	921,00	873,00	957,00	957,00	1037,00	957,00	957,00
40.797	40.799	with electric strike release top and floor/top locking profile cylinder bolt lock, x = 55/65	693,00	718,00	753,00	718,00	913,00	913,00	951,00	913,00	913,00
40.796	40.798	do. bottom	693,00	718,00	753,00	718,00	913,00	913,00	951,00	913,00	913,00

Please indicate exact glass thickness with order.  
The prices given are valid for TSG in 10 mm glass thickness.  
For surcharges for other glass thicknesses or for LSG please see page 296.

\*\*\* Preparation times for surface 398 on request

**105 mm high, for single action doors with 24 mm rebate depth,  
up to 1100 mm door width, door strap 40 mm  
TP/TA EASY Safe, complete for 10 mm glass thickness as standard**

Art. No. DIN LH	Art. No. DIN RH	Description	AL mill finish (100)	AL anod Silver (150)	AL anod sim. Stain- Steel satin (157)	Al p-coat Traffic white (350)	AL p-coat sim. Anod EV1 (318)	AL p-coat Special color weather resist. *** (398)	Stain- Steel satin (700)	AL anod Special (199)	AL p-coat Special color (399)
			€/Piece	€/Piece	€/Piece	€/Piece	€/Piece	€/Piece	€/Piece	€/Piece	€/Piece
<p><b>Door rails, 105 mm high, for single action doors with 24 mm rebate depth, without lock</b> color no. 700 = door strap in AL sim satin stain steel anod C31 (113) Please indicate exact door width!</p>											
40.736	40.738	without lock, top with free glass edge left and right	390,00	419,00	419,00	419,00	565,00	565,00	581,00	565,00	565,00
40.735	40.737	do. bottom	390,00	419,00	419,00	419,00	565,00	565,00	581,00	565,00	565,00
40.740	40.742	without lock, top with free glass edge at hanging side	379,00	403,00	403,00	403,00	548,00	548,00	560,00	548,00	548,00
40.739	40.741	do. bottom	379,00	403,00	403,00	403,00	548,00	548,00	560,00	548,00	548,00
<p><b>Door rails, 105 mm high, for single action doors with 24 mm rebate depth, with profile cylinder lock</b> color no. 700 = door strap in AL sim satin stain steel anod C31 (113) Please indicate exact door width</p>											
40.756	40.758	with floor/top locking bolt lock top and free glass edge left and right	606,00	641,00	641,00	641,00	760,00	760,00	802,00	760,00	760,00
40.755	40.757	do. bottom	606,00	641,00	641,00	641,00	760,00	760,00	802,00	760,00	760,00
40.760	40.762	with floor/top locking top bolt lock and free glass edge at hanging side	592,00	623,00	623,00	623,00	744,00	744,00	782,00	744,00	744,00
40.759	40.761	do. bottom	592,00	623,00	623,00	623,00	744,00	744,00	782,00	744,00	744,00
40.776	40.778	with side locking bolt lock top and free glass edge at hanging side	661,00	683,00	683,00	683,00	893,00	893,00	962,00	893,00	893,00
40.775	40.777	do. bottom	661,00	683,00	683,00	683,00	893,00	893,00	962,00	893,00	893,00

Please indicate exact glass thickness with order.  
The prices given are valid for TSG in 10 mm glass thickness.  
For surcharges for other glass thicknesses or for LSG please see page 296.

\*\*\* Preparation times for surface 398 on request

2 5 10 15 20 25

**105 mm high, for single action doors with 24 mm rebate depth,  
up to 1100 mm door width, door strap 40 mm  
TP/TA EASY Safe, complete for 10 mm glass thickness as standard**

Art. No. DIN LH	Art. No. DIN RH	Description	AL mill finish (100)	AL anod Silver (150)	AL anod sim. Stain- Steel satin (157)	Al p-coat Traffic white (350)	AL p-coat sim. Anod EV1 (318)	AL p-coat Special color weather resist. (398) ***	Stain- Steel satin (700)	AL anod Special (199)	AL p-coat Special color (399)
			€/Piece	€/Piece	€/Piece	€/Piece	€/Piece	€/Piece	€/Piece	€/Piece	€/Piece
<p><b>Door rails, 105 mm high, for single action doors with 24 mm rebate depth, with/for electric strike release</b> color no. 700 = door strap in Alu. similar satin stainless steel C 31 (113). Please indicate exact door width!</p>											
40.744	40.746	with profile cylinder latch top lock at side for electric strike release and floor/top locking bolt lock, free glass edge at hanging side	819,00	845,00	890,00	845,00	967,00	967,00	1049,00	967,00	967,00
40.743	40.745	do. bottom	819,00	845,00	890,00	845,00	967,00	967,00	1049,00	967,00	967,00
40.748	40.750	with electric strike release at side and floor/top locking profile cylinder bolt lock, free glass edge at hanging side	859,00	891,00	935,00	891,00	1029,00	1029,00	1070,00	1029,00	1029,00
40.747	40.749	do. bottom	859,00	891,00	935,00	891,00	1029,00	1029,00	1070,00	1029,00	1029,00

Please indicate exact glass thickness with order.  
The prices given are valid for TSG in 10 mm glass thickness.  
For surcharges for other glass thicknesses or for LSG please see page 296.

\*\*\* Preparation times for surface 398 on request

**105 mm high, for single action doors with 24 mm rebate depth,  
up to 1100 mm door width, door strap 34 mm,  
TP/TA EASY Safe, complete for 10 mm glass thickness as standard**

Art. No. DIN LH	Art. No. DIN RH	Description	AL mill finish (100)	AL anod Silver (150)	AL anod sim. Stain- Steel satin (157)	Al p-coat Traffic white (350)	AL p-coat sim. Anod EV1 (318)	AL p-coat Special color weather resist. *** (398)	Stain- Steel satin (700)	AL anod Special (199)	AL p-coat Special color (399)
			€/Piece	€/Piece	€/Piece	€/Piece	€/Piece	€/Piece	€/Piece	€/Piece	€/Piece

**Door rails, 105 mm high, for single action doors  
without rebate, without lock**  
color no. 700 =  
door strap in AL sim satin stain steel anod C31 (113)  
Please indicate exact door width!

40.732	40.734	without lock	top	365,00	387,00	426,00	387,00	522,00	522,00	592,00	522,00	522,00
40.731	40.733	do.	bottom	365,00	387,00	426,00	387,00	522,00	522,00	592,00	522,00	522,00

**Door rails, 105 mm high, for single action doors  
without rebate, with profile cylinder lock**  
color no. 700 =  
door strap in AL sim satin stain steel anod C31 (113)  
Please indicate exact door width!

40.752	40.754	with floor locking lock/ top locking bolt lock	top	577,00	607,00	656,00	607,00	727,00	727,00	764,00	727,00	727,00
40.751	40.753	dto	bottom	577,00	607,00	656,00	607,00	727,00	727,00	764,00	727,00	727,00
40.772	40.774	with side locking bolt lock	top	644,00	669,00	718,00	669,00	876,00	876,00	935,00	876,00	876,00
40.771	40.773	do.	bottom	644,00	669,00	718,00	669,00	876,00	876,00	935,00	876,00	876,00

**Please indicate exact glass  
thickness with order.  
The prices given are valid for TSG  
in 10 mm glass thickness.  
For surcharges for other glass  
thicknesses or for LSG please see  
page 296.**

\*\*\* Preparation times for surface 398 on request

**105 mm high, for single action doors with 24 mm rebate depth, up to 1100 mm door width, door strap 34 mm, TP/TA EASY Safe, complete for 10 mm glass thickness as standard**

Art. No. DIN LH	Art. No. DIN RH	Description	AL mill finish (100)	AL anod Silver (150)	AL anod sim. Stain-Steel satin (157)	Al p-coat Traffic white (350)	AL p-coat sim. Anod EV1 (318)	AL p-coat Special color weather resist. (398)***	Stain-Steel satin (700)	AL anod Special (199)	AL p-coat Special color (399)
			€/Piece	€/Piece	€/Piece	€/Piece	€/Piece	€/Piece	€/Piece	€/Piece	€/Piece

**Door rails, 105 mm high, for single action doors with 24 mm rebate depth, with/for electric strike release**  
 color no. 700 = door strap in Alu. similar satin stainless steel C 31 (113)  
 Please indicate exact door width!

40.780	40.782	with profile cylinder latch lock at side for electric strike release and with floor/top locking bolt lock	top	803,00	831,00	877,00	831,00	957,00	957,00	1037,00	957,00	957,00
40.779	40.781	do.	bottom	803,00	831,00	877,00	831,00	957,00	957,00	1037,00	957,00	957,00
40.784	40.786	with electric strike release at side and floor/ top locking profile cylinder bolt lock	top	847,00	876,00	920,00	876,00	1014,00	1014,00	1056,00	1014,00	1014,00
40.783	40.785	do.	bottom	847,00	876,00	920,00	876,00	1014,00	1014,00	1056,00	1014,00	1014,00

Please indicate exact glass thickness with order.  
 The prices given are valid for TSG in 10 mm glass thickness.  
 For surcharges for other glass thicknesses or for LSG please see page 296.

Patch fittings and profile systems

## 105 mm high, for sidelights TP/TA EASY Safe, complete for 10 mm glass thickness as standard

Art. No. DIN LH	Art. No. DIN RH	Description		AL mill finish (100)	AL anod Silver (150)	AL anod sim. Stain- Steel satin (157)	Al p-coat Traffic white (350)	AL p-coat sim. Anod EV1 (318)	AL p-coat Special color weather resist. (398) ***	Stainl- Steel satin (700)	AL anod Special (199)	AL p-coat Special color (399)
				€/Piece	€/Piece	€/Piece	€/Piece	€/Piece	€/Piece	€/Piece	€/Piece	€/Piece
<b>Door rails, 105 mm high, for sidelights</b> Please indicate exact panel width!												
40.902	40.902	with filler profile, top 3 mm, bottom 7 mm, up to 6000 mm length	top	€/m 301,00	€/m 328,00	€/m 364,00	€/m 328,00	€/m 447,00	€/m 447,00	€/m 496,00	€/m 447,00	€/m 447,00
40.901	40.901	do.	bottom	€/m 301,00	€/m 328,00	€/m 364,00	€/m 328,00	€/m 447,00	€/m 447,00	€/m 496,00	€/m 447,00	€/m 447,00
40.912	40.914	with electric strike release, price for panel width up to 1200 mm (>1200 mm on request)	top	€/m 884,00	€/m 914,00	€/m 965,00	€/m 914,00	€/m 957,00	€/m 957,00	€/m 1037,00	€/m 957,00	€/m 957,00
40.911	40.913	do.	bottom	€/m 884,00	€/m 914,00	€/m 965,00	€/m 914,00	€/m 957,00	€/m 957,00	€/m 1037,00	€/m 957,00	€/m 957,00
40.916	40.916	with strike-box for side locking profile cylinder bolt lock, price for panel width up to 1200 mm (>1200 mm on request)	top	€/m 431,00	€/m 453,00	€/m 493,00	€/m 453,00	€/m 577,00	€/m 577,00	€/m 625,00	€/m 577,00	€/m 577,00
40.915	40.915	do.	bottom	€/m 431,00	€/m 453,00	€/m 493,00	€/m 453,00	€/m 577,00	€/m 577,00	€/m 625,00	€/m 577,00	€/m 577,00

Please indicate exact glass  
thickness with order.  
The prices given are valid for TSG  
in 10 mm glass thickness.  
For surcharges for other glass  
thicknesses or for LSG please see  
page 296.

\*\*\* Preparation times for surface 398 on request

2 5 10 15 20 25

**105 mm high, prepared for round cylinder, for double action doors up to 1200 mm door width  
TP/TA EASY Safe, complete for 10 mm glass thickness as standard**

Art. No. DIN LH	Art. No. DIN RH	Description	AL mill finish (100)	AL anod Silver (150)	AL anod sim. Stain- Steel satin (157)	Al p-coat Traffic white (350)	AL p-coat sim. Anod EV1 (318)	AL p-coat Special color weather resist. (398) ***	Stain- Steel satin (700)	AL anod Special (199)	AL p-coat Special color (399)
			€/Piece	€/Piece	€/Piece	€/Piece	€/Piece	€/Piece	€/Piece	€/Piece	€/Piece
<p><b>Door rails, 105 mm high, for double action doors, for floor locking / top locking, prepared for round cylinder</b> Please indicate exact door width!</p>											
40.764	40.764	with bolt lock, x = 55/65 top	532,00	563,00	604,00	563,00	640,00	640,00	701,00	640,00	640,00
40.763	40.763	do. bottom	532,00	563,00	604,00	563,00	640,00	640,00	701,00	640,00	640,00
40.766	40.766	with bolt lock, with pin, x = 20 top	626,00	657,00	697,00	657,00	721,00	721,00	782,00	721,00	721,00
40.765	40.765	do. bottom	626,00	657,00	697,00	657,00	721,00	721,00	782,00	721,00	721,00
40.768	40.768	with bolt lock, prepared for floor bearing, x = 20 bottom	592,00	622,00	569,00	622,00	696,00	696,00	753,00	696,00	696,00
40.767	40.767	with bolt lock, prepared for RTS, x = 65 top	610,00	628,00	669,00	628,00	696,00	696,00	757,00	696,00	696,00

Please indicate exact glass thickness with order.  
The prices given are valid for TSG in 10 mm glass thickness.  
For surcharges for other glass thicknesses or for LSG please see page 296.

Single-action doors with bolt lock prepared for round cylinder on request.

\*\*\* Preparation times for surface 398 on request

## Special glass thicknesses / Accessories and single parts for door rails TP/TA EASY Safe

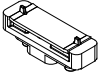
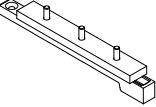
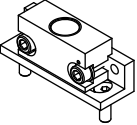
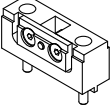
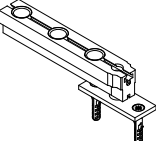
Art. No.	Description	€/Piece
<p><b>Surcharge for glass thicknesses 10,76 / 12 / 12,76 / 13,5 / 15 / 17 / 19 mm for TSG, STG and LSG made from 2 x TSG. Please indicate glass thickness!</b></p> <p><b>This option applies to all 105 mm high door rails.</b></p>		
8.40.000.100.50	Surcharge for door rails with glass thickness greater than 10 mm made of TSG	42,50
8.40.000.131.50	Surcharge for door rails with LSG glazing	45,00
8.40.000.106.50	Surcharge for modified door strap for single-action doors, as rebate depth deviates from 24 mm (max. door weight 80 kg, max. door width 1000 mm)	45,00
<p><b>Accessories and single parts</b></p>		
40.072	Brush for door rail, stock length 2000 mm. When using inside and outside, take into account twice the door rail length as a dimension	9,60
	40.071 Insert for door rails for dormakaba BTS and floor-bearing, stainless steel	73,50
	40.567 Bottom strap in forged steel, assembled in door rails for double action doors	72,50
	40.578 Top insert, two-piece for top door rail (easier installation)	44,00
	40.577 Upper insert, galvanised steel, ES for dormakaba RTS transom closer, zinc plated steel, 65 mm pivot point	81,50
	40.566 Screw-on floor bearing moistureproof, compl. with insert for door rails, max. 100 kg.	81,50

\*\*\* Preparation times for surface 398 on request



## Notes

# Door rails TP / TA 76.5



Technical data	
Glass	TSG
Glass thickness	8, 10, 12 mm
Max. door weight	150 kg
Lock application	Profile cylinder, round cylinder
Applications	1-/2 panels, sidelight, overpanel, toughened glass assembly
Material	Aluminium, stainless steel
Finishes	Anodised- and RAL-Colors (coated), brass, stainless steel
Specials	Combinable with EA- and Universal fittings. Suitable for outdoor assemblies. Variants for bullet-proof glass on request.

## Fittings for toughened glass assemblies

**184** Patch fitting MUNDUS Comfort

**190** Patch fitting MUNDUS Premium

**198** Patch fitting UNIVERSAL

**207** Patch fitting UNIVERSAL Motion NG33

**208** Patch fitting UNIVERSAL light

**210** Single action door fitting BEYOND

**216** EA-Patch fittings for single action doors

**222** Door rails TP/TA EASY Safe

**234** Door rails TP/TA 76.5

**242** Single action door fitting MANET

**250** Wall connecting profiles

**256** Frame systems MR 22 & MR 28

**260** Centre and corner locks SG, strike boxes

### General accessories for toughened glass assemblies

**270** Clamping fitting, U-profile

**271** Pivot bearing, floor bearing, strike plates, floor sockets, profile cylinders

### Example view for Door rails

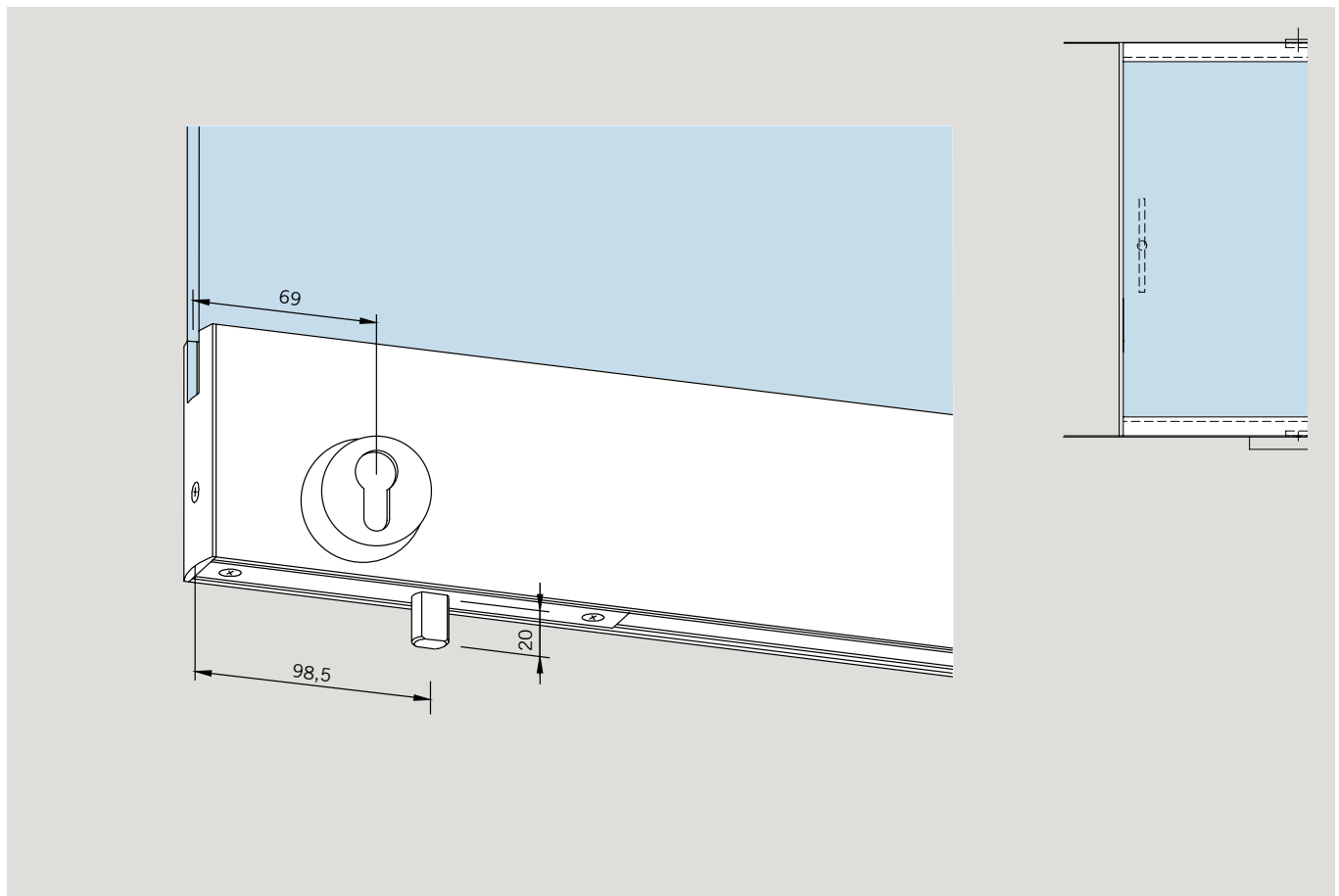

## TP/TA 76.5 mm high, for double action doors up to 1200 mm door width, complete for 10 mm glass thickness as standard

Art. No. DIN LH	Art. No. DIN RH	Description	Base parts (000)	AL mill finish (100)	AL anod EV1 (101)	Al p-coat Traffic white (300)	AL anod dark bronze (108)	Stainl- Steel satin (700)	AL anod Special (199)	AL p-coat Special color (399)
			€/Piece	€/Piece	€/Piece	€/Piece	€/Piece	€/Piece	€/Piece	€/Piece
<b>Door rails, 76.5 mm high, for double action doors, without lock</b>			Please indicate exact door width!							
04.002	04.002	without lock, x = 55/65	top	218,00	237,00	237,00	266,00	390,00	331,00	331,00
04.001	04.001	do.	bottom	218,00	237,00	237,00	266,00	390,00	331,00	331,00
04.004	04.004	without lock, prepared for dormakaba BTS, x = 18	top	309,00	327,00	327,00	357,00	478,00	438,00	438,00
04.003	04.003	do.	bottom	309,00	327,00	327,00	357,00	478,00	438,00	438,00
04.007	04.007	without lock, prepared for floor bearing, x = 18	bottom	277,00	296,00	296,00	322,00	448,00	406,00	406,00
04.006	04.006	without lock, prepared for dormakaba RTS, x = 65	top	281,00	303,00	303,00	339,00	457,00	408,00	408,00
<b>Door rails, 76.5 mm high, for double action doors, with floor locking lock/top locking PZ bolt lock</b>			Please indicate exact door width!							
04.012	04.012	with bolt lock, x = 55/65	top	441,00	470,00	470,00	611,00	698,00	634,00	634,00
04.011	04.011	do.	bottom	441,00	470,00	470,00	611,00	698,00	634,00	634,00
04.014	04.014	with bolt lock, prepared for dormakaba BTS, x = 18	top	530,00	560,00	560,00	720,00	788,00	727,00	727,00
04.013	04.013	do.	bottom	530,00	560,00	560,00	720,00	788,00	727,00	727,00
04.017	04.017	with bolt lock, prepared for floor bearing, x = 18	bottom	498,00	527,00	527,00	560,00	754,00	692,00	692,00
04.016	04.016	with bolt lock, prepared for dormakaba RTS, x = 65	top	505,00	535,00	535,00	567,00	761,00	692,00	692,00
		Surcharge per door rail for version 8 + 12 mm glass thickness		5,20						

**TP/TA 76.5 mm high, for single action doors with 24 mm rebate depth up to 1100 mm door width, door strap 40 mm, complete for 10 mm glass thickness as standard**

Base parts (000)	AL mill finish (100)	AL anod EV1 (101)	Al p-coat Traffic white (300)	AL anod dark bronze (108)	Stainl-Steel satin (700)	AL anod Special (199)	AL p-coat Special color (399)
------------------	----------------------	-------------------	-------------------------------	---------------------------	--------------------------	-----------------------	-------------------------------

Art. No. DIN LH	Art. No. DIN RH	Description		€/Piece	€/Piece	€/Piece	€/Piece	€/Piece	€/Piece	€/Piece	€/Piece
<p><b>Door rails, 76.5 mm high, for single action doors with 24 mm rebate depth, without lock</b>                      color no. 700 = door strap in Alu. similar satin stainless steel C 31                      Please indicate exact door width!</p>											
04.036	04.038	with free glass edge left and right	top	289,00	312,00	312,00	342,00	528,00	423,00	423,00	
04.035	04.037	do.	bottom	289,00	312,00	312,00	342,00	528,00	423,00	423,00	
04.040	04.042	with free glass edge at hanging side	top	278,00	297,00	297,00	330,00	508,00	408,00	408,00	
04.039	04.041	do.	bottom	278,00	297,00	297,00	330,00	508,00	408,00	408,00	
<p><b>Door rails, 76.5 mm high, for single action doors with 24 mm rebate depth, with lock</b>                      color no. 700 = door strap in Alu. similar satin stainless steel C 31                      Please indicate exact door width!</p>											
04.056	04.058	with floor/top locking bolt lock and free glass edge left and right	top	513,00	542,00	542,00	581,00	837,00	708,00	708,00	
04.055	04.057	do.	bottom	513,00	542,00	542,00	581,00	837,00	708,00	708,00	
04.060	04.062	with floor/top locking bolt lock and free glass edge at hanging side	top	502,00	528,00	528,00	567,00	815,00	692,00	692,00	
04.059	04.061	do.	bottom	502,00	528,00	528,00	567,00	815,00	692,00	692,00	
		Surcharge per door rail for version 8 + 12 mm glass thickness		5,20							

Patch fittings and profile systems

**TP/TA 76.5 mm high, for single action doors without rebate, up to 1200 mm door width,  
door strap 34 mm; door rails for sidelights, complete for 10 mm glass thickness as standard**

Art. No. DIN LH	Art. No. DIN RH	Description	Base parts (000)	AL mill finish (100)	AL anod EV1 (101)	Al p-coat Traffic white (300)	AL anod dark bronze (108)	Stainl- Steel satin (700)	AL anod Special (199)	AL p-coat Special color (399)
			€/Piece	€/Piece	€/Piece	€/Piece	€/Piece	€/Piece	€/Piece	€/Piece
<b>Door rails, 76.5 mm high, for single action doors without rebate, without lock</b> color no. 700 = door strap in Alu. similar satin stainless steel C 31 (113), Please indicate exact door width!										
04.032	04.034	without lock	top	265,00	285,00	285,00	315,00	484,00	389,00	389,00
04.031	04.033	do.	bottom	265,00	285,00	285,00	315,00	484,00	389,00	389,00
<b>Door rails, 76.5 mm high, for single action doors without rebate, with lock</b> color no. 700 = door strap in Alu. similar satin stainless steel C 31, Please indicate exact door width!										
04.052	04.054	with floor locking lock/ top locking bolt lock	top	488,00	515,00	515,00	551,00	793,00	675,00	675,00
04.051	04.053	do.	bottom	488,00	515,00	515,00	551,00	793,00	675,00	675,00
<b>Door rails for side lights, 76,5 mm high</b> Please indicate exact door width!										
04.202	04.202	with bottom filler profile, top 3 mm, bottom 7 mm, up to 6000 mm length	top	€/m 210,00	€/m 231,00	€/m 231,00	€/m 264,00	€/m 361,00	€/m 325,00	€/m 325,00
04.201	04.201	do.	bottom	€/m 210,00	€/m 231,00	€/m 231,00	€/m 264,00	€/m 361,00	€/m 325,00	€/m 325,00
		Surcharge per door rail for version 8 + 12 mm glass thickness		5,20						

**TP/TA 76.5 mm high, for double action doors up to 1200 mm door width, complete for 10 mm glass thickness as standard**





Base parts (000)	AL mill finish (100)	AL anod EV1 (101)	Al p-coat Traffic white (300)	AL anod dark bronze (108)	Stainl-Steel satin (700)	AL anod Special (199)	AL p-coat Special color (399)
------------------	----------------------	-------------------	-------------------------------	---------------------------	--------------------------	-----------------------	-------------------------------

Art. No. DIN LH	Art. No. DIN RH	Description		€/Piece	€/Piece	€/Piece	€/Piece	€/Piece	€/Piece	€/Piece	€/Piece
<p><b>Door rails, 76.5 mm high, for double action doors with floor/top locking bolt lock prepared for round cylinder</b> Please indicate exact door width!</p>											
04.064	04.064	with bolt lock, x = 55/65	top	468,00	497,00	497,00	637,00	725,00	664,00	664,00	
04.063	04.063	do.	bottom	468,00	497,00	497,00	637,00	725,00	664,00	664,00	
04.066	04.066	with bolt lock, prepared for dormakaba BTS, x = 18	top	558,00	588,00	588,00	745,00	815,00	754,00	754,00	
04.065	04.065	do.	bottom	558,00	588,00	588,00	745,00	815,00	754,00	754,00	
04.068	04.068	with bolt lock, prepared for floor bearing, x = 18	bottom	525,00	552,00	552,00	589,00	783,00	716,00	716,00	
04.067	04.067	with bolt lock, prepared for dormakaba RTS, x = 65	top	530,00	560,00	560,00	595,00	788,00	716,00	716,00	
		Surcharge per door rail for version 8 + 12 mm glass thickness		5,20							

**Single action doors with locking bolt lock prepared for round cylinder on request!**

Patch fittings and profile systems

## Accessories for special glass thicknesses, door rails TP/TA 76.5

Art. No.	Description	Base parts (000)	AL mill finish (100)	AL anod EV1 (101) Al p-coat Traffic white (300)	AL anod dark bronze (108)	AL anod sim. Stainl-Steel satin (113)	AL anod Special (199)
		€/Piece	€/Piece	€/Piece	€/Piece	€/Piece	€/Piece
<b>Spare parts</b>							
	<b>04.600</b> Bottom brush profile for door rail, price for door width up to 1200 mm > 1200 mm on request	top / bottom	<b>87,00</b>				
	<b>04.604</b> Insert for roor rails for dormakaba BTS and floor-bearing, stainless steel	bottom	<b>24,00</b>				
	<b>04.605</b> Bottom strap in forged steel, assembled in door rails for double action doors – normal frequented doors, max. door weight 150 kg, max. door width 1400 mm – high frequented doors, max. door weight 120 kg, max. door width 1200 mm x = 55/65 mm (Please indicate)	bottom	<b>70,00</b>				
	<b>04.606</b> Top insert, two-piece for top door rail (easier installation)	top	<b>43,00</b>				
	<b>04.607</b> Rubber sealing for door rails fixed length	top / bottom	€/m <b>4,20</b>				
	<b>04.608</b> do., stock length 200 m (= 1 roll)	top / bottom	€/piece <b>708,00</b>				
	<b>04.950</b> Surcharge for one sided mitre-cut		<b>46,00</b>				
	<b>01.136</b> Screw-on floor bearing moistureproof, compl. with insert for door rails, max. 100 kg	bottom	<b>71,00</b>				
	<b>04.900</b> Surcharge for changed lever due to rebate depth different from 24 mm (max. door weight 80 kg, max. door width 1000 mm)			<b>11,00</b>	<b>13,50</b>	<b>17,00</b>	<sup>(700)</sup> <b>44,00</b> <b>19,50</b>



## Notes

# MANET



**Attention:** The products listed in this chapter are intended exclusively for glass construction not requiring approval.



reddot design award



Technical data	
Glass	TSG and LSG (2 x TSG)
Glass thickness	10, 12 and 13,5 mm
max. door panel weight	80 kg for sets with short type pivot poles, 100 kg for applications with long pivot pole
Applications	MANET locks
Material	1-/2-panels, sidelight, overpanel, toughened glass assembly
Finishes	Stainless steel AISI 303, (not for indoor swimming pools or salt-water pools)
Kind of installation	Satin stainless steel
Specials	Readjustable without dismantling

## Fittings for toughened glass assemblies

- 184** Patch fitting MUNDUS Comfort
- 190** Patch fitting MUNDUS Premium
- 198** Patch fitting UNIVERSAL
- 207** Patch fitting UNIVERSAL Motion NG33
- 208** Patch fitting UNIVERSAL light
- 210** Single action door fitting BEYOND
- 216** EA-Patch fittings for single action doors
- 222** Door rails TP/TA EASY Safe
- 234** Door rails TP/TA 76.5
- 242** Single action door fitting MANET
- 250** Wall connecting profiles
- 256** Frame systems MR 22 & MR 28
- 260** Centre and corner locks SG, strike boxes

### General accessories for toughened glass assemblies

- 270** Clamping fitting, U-profile
- 271** Pivot bearing, floor bearing, strike plates, floor sockets, profile cylinders

### Example view for MANET

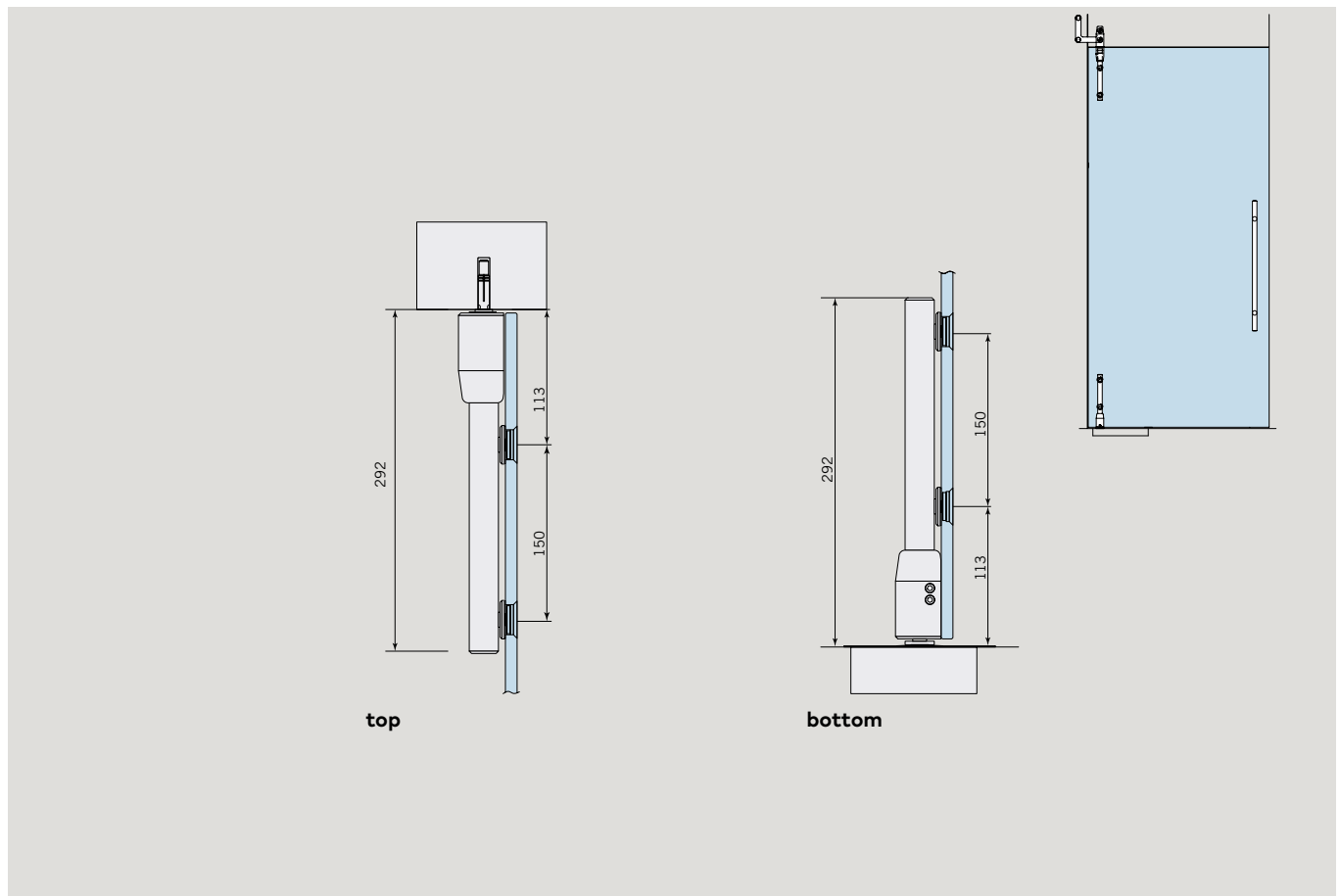

**Set 1**

Stainl-Steel satin (700)

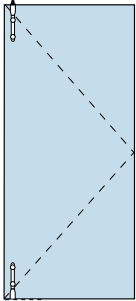
Art. No.	Description	€/Piece
<b>Complete sets</b>		
	<p><b>29.910</b> Set 1 with <b>countersunk</b> single-point fixings</p> <p><b>Pivot door MANET without overpanel for 10 – 13.5 mm glass</b></p> <p>consisting of: Pair of top/bottom pivot poles, short type</p> <p>incl.:</p> <ul style="list-style-type: none"> <li>4 Single-point fixings for pivot poles,</li> <li>1 Top pivot bearing,</li> <li>1 PT 25 pivot 15 mm Ø with plug</li> <li>1 Bottom pivot bearing for dormakaba BTS and floor bearing</li> <li>1 top pivot bearing (PT25)</li> </ul>	<p><b>361,00</b></p>
		

Patch fittings and profile systems

**Application example for SET 1**

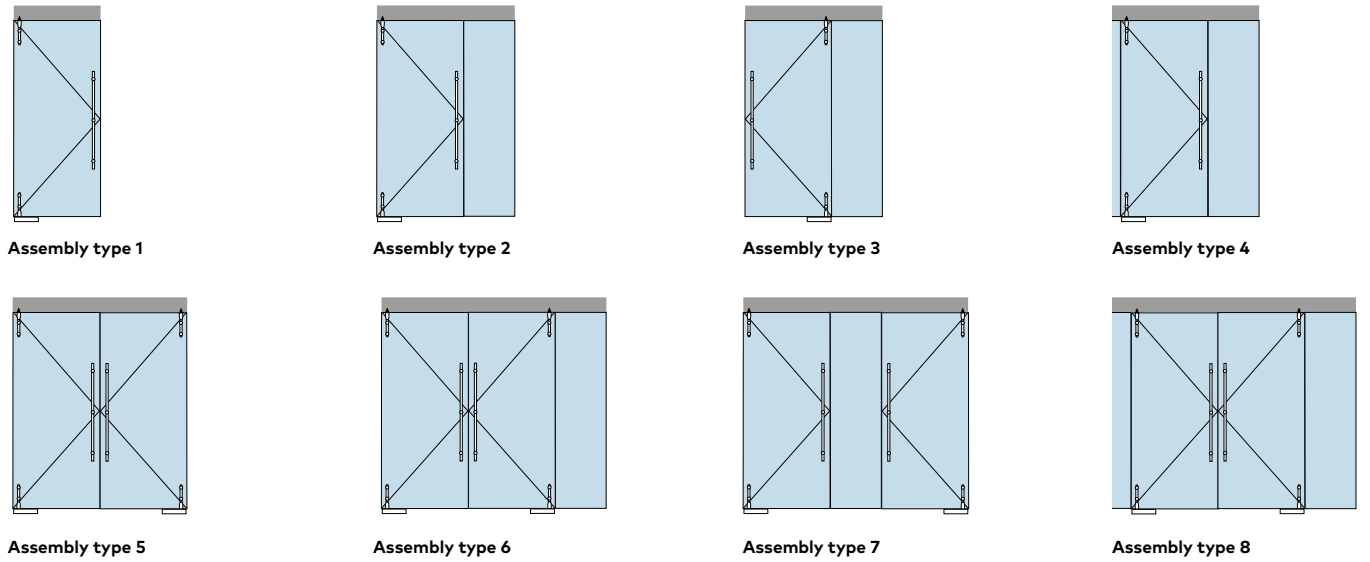

Assembly type 1

Assembly type 2

Assembly type 3

Assembly type 4

Assembly type 5

Assembly type 6

Assembly type 7

Assembly type 8





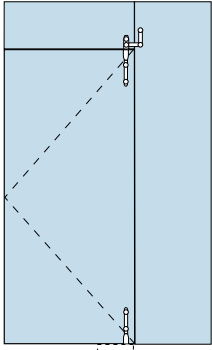



**Set 3**

Stainl-Steel satin (700)









Art. No.	Description	€/Piece
<b>Complete sets</b>		
<b>Pivot door MANET with overpanel and sidelight for 10 – 13.5 mm glass</b>	<p><b>29.914</b> SET 3 with <b>countersunk</b> single-point fixings</p> <p>consisting of: Pair of top/bottom pivot poles, short type</p> <p>incl. 4 Single-point fixings for pivot poles, 1 Top pivot bearing, 1 Overpanel/sidelight connector with pivot bearing location, 1 Bottom pivot bearing for dormakaba BTS and floor bearing</p>	<b>541,00</b>
		

## Components for pivoting doors







Stainl-  
Steel  
satin  
(700)

Art. No.	Description	€/Piece
	<b>29.551</b> Pivot pole, drilled, fixed length	€/m <b>221,00</b>
<b>29.460</b>	<b>Single-point fixing, track to glass, countersunk, for 10-13,5 mm Glas</b> fixed	<b>20,00</b>
<b>29.462</b>	<b>do.</b> centering	<b>29,50</b>
	<b>29.545</b> Pivot bearing for dormakaba BTS (max. EN 4) / floor pivot Zero position adjustable	<b>96,50</b>
	<b>21.310</b> Pivot bearing for overpanel and ceiling connection	<b>77,00</b>
	<b>21.319</b> Pivot bearing for ceiling connection, adjustable	<b>122,00</b>
	<b>29.333</b> Pivot bearing location for overpanel with countersunk single-point fixings for 10-13,5 mm glass	<b>150,00</b>
	<b>29.330</b> Overpanel/sidelight connector RH/LH with pivot bearing location, complete assembly with countersunk single-point fixings for 10-13,5 mm glass	<b>282,00</b>
	<b>29.320</b> Overpanel/sidelight connector right/left with countersunk single-point fixings for 10-13,5 mm glass	<b>182,00</b>
	<b>21.334</b> Stop for pivoting door for ceiling installation	<b>59,00</b>
	<b>29.335</b> <b>Door stop at overpanel</b> (indoor/outdoor), for 10-13,5 mm glass	<b>99,50</b>

## Connectors

Art. No.	Description	€/Piece	€/Piece
		Base parts (000)	Stainl-Steel satin (700)
	<b>29.337 Ceiling connector</b> (carrying function max. 35 kg/piece) for 10-13,5 mm glass with countersunk single-point fixing		<b>123,00</b>
	<b>29.145 Connector 90°, glass/ceiling or glass/floor</b> for 10-13,5 mm glass (only supporting, no carrying function)		<b>78,50</b>
	<b>Glass/glass corner connector 90 180°</b> for 8 - 13,5 mm glass, with connecting rod 60 mm		<b>95,00</b>
<b>29.122</b>	connecting rod 103 mm		<b>95,00</b>
	<b>Glass/wall corner connector 90 180°</b> for 8 - 13,5 mm glass, with connecting rod 60 mm		<b>102,00</b>
<b>29.140</b>	connecting rod 103 mm		<b>102,00</b>
	<b>01.115</b> PT 25 pivot, 15 mm Ø, with plug		<b>6,30</b>
	<b>01.117</b> PT 21, pivot with retractable bolt, diametre 15 mm		<b>47,50</b>
	<b>01.123</b> <b>PT 24, pivot with fixing plate</b> , 3 mm to screw on the ceiling		<b>26,50</b>
	<b>29.950</b> <b>Stop for pivoting door</b> , floor mounting		<b>40,00</b>

## Accessories

		Base parts (000)	Stainl-Steel satin (700)
Art. No.	Description	€/Piece	€/Piece
	<b>21.449</b> <b>Dead lock with profile cylinder rose</b> on inside for 8 - 13,5 mm glass		<b>185,00</b>
	<b>05.194</b> <b>Eccentric bushing</b> for dead lock 21.448 / 21.449 / 21.450	<b>28,00</b>	
	<b>14.206</b> <b>Profile cylinder</b> 66 mm cylinder length (30,5 + 35,5 mm) for dead lock 21.448 / 21.449	<b>26,00</b>	
	<b>05.190</b> <b>Strike plate</b>	<b>16,50</b>	
	<b>29.217</b> 5 pcs. of <b>clip-on cover</b> with spring for single-point fixing	<b>26,00</b>	
	<b>21.134</b> <b>Assembling tool</b> for MANET single-point fixings	<b>15,00</b>	



## Notes

# Wall connecting profiles



Technical data	
Glass	TSG
Glass thickness	8 - 19 mm
max. bearing load	15 kg each clamp piece
Applications	To fix overpanels and sidelights
Material	Base profile Aluminium, cover profile Aluminium or Stainless steel
Finishes	Anodised- and RAL-Colors (coated), stainless steel
Specials	Safe enclosure toughened glass assemblies Simple installation

## Fittings for toughened glass assemblies

**184** Patch fitting MUNDUS Comfort

**190** Patch fitting MUNDUS Premium

**198** Patch fitting UNIVERSAL

**207** Patch fitting UNIVERSAL Motion NG33

**208** Patch fitting UNIVERSAL light

**210** Single action door fitting BEYOND

**216** EA-Patch fittings for single action doors

**222** Door rails TP/TA EASY Safe

**234** Door rails TP/TA 76.5

**242** Single action door fitting MANET

**250** Wall connecting profiles

**256** Frame systems MR 22 & MR 28

**260** Centre and corner locks SG, strike boxes

### General accessories for toughened glass assemblies



**270** Clamping fitting, U-profile

**271** Pivot bearing, floor bearing, strike plates, floor sockets, profile cylinders

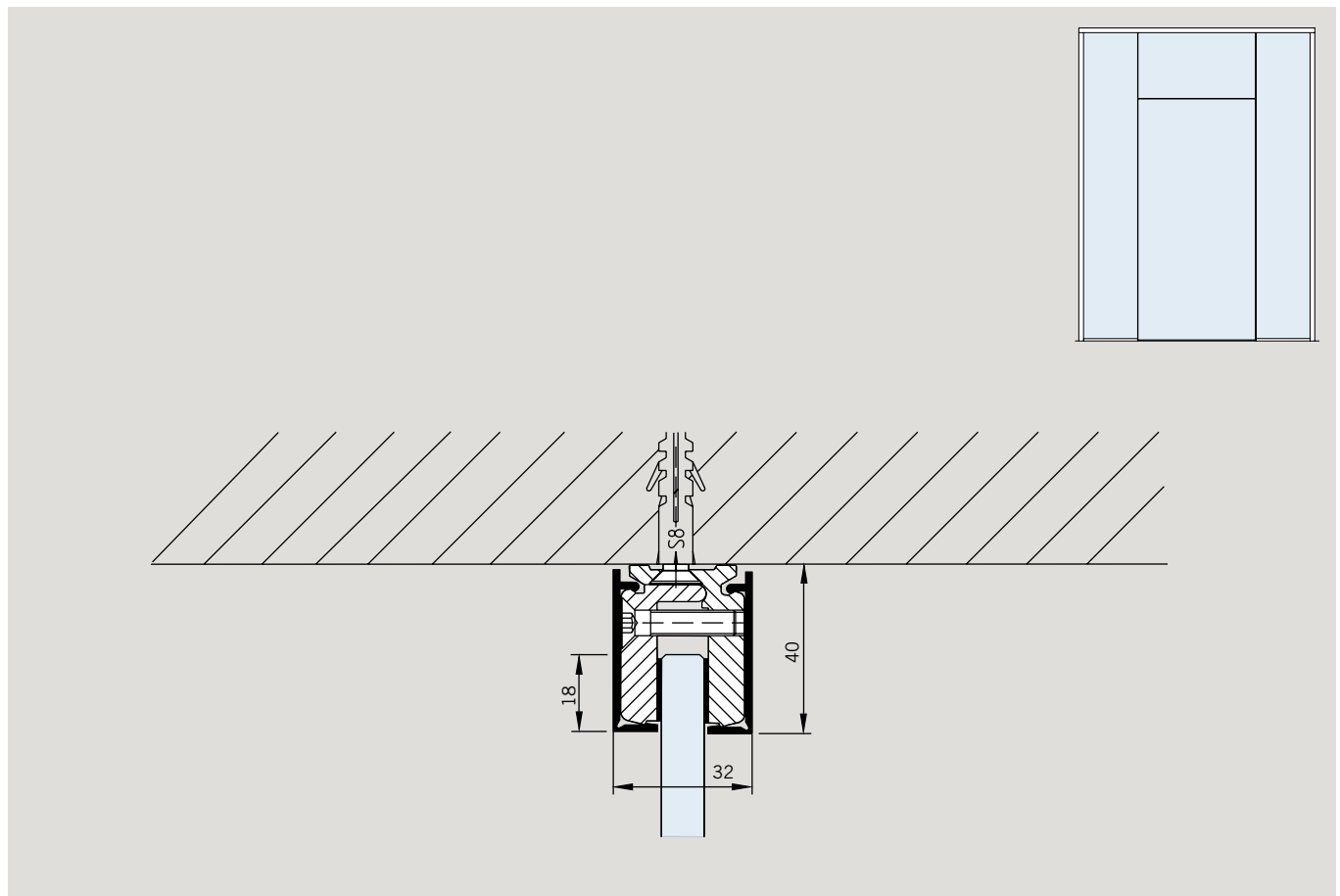
### Example view for wall connecting profile

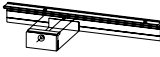
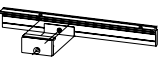

## Single components







Art. No.	Description	Base parts (000)	AL mill finish (100)	AL anod Silver (150)	Al p-coat Traffic white (300)	AL anod sim. Stainl-Steel satin (157)	Stainl-Steel satin (700) Stainl-Steel polished (701)	AL anod Special (199)	AL p-coat Special color (399)
		€/piece	€/piece	€/piece	€/piece	€/piece	€/piece	€/piece	€/piece
	<b>Base profile</b> with fixing holes, incl. clamping parts with screws and gasket strips, <b>6000 mm stock length</b>								
07.042	base profile for 8 mm glass thickness	366,00							
07.001	base profile for 10 mm glass thickness	337,00							
07.002	base profile for 12 mm glass thickness	388,00							
07.045	base profile for 12,7 mm glass thickness	417,00							
07.046	base profile for 13,5 mm glass thickness	417,00							
07.047	base profile for 15 mm glass thickness	417,00							
07.048	base profile for 17 mm glass thickness	417,00							
07.049	base profile for 19 mm glass thickness	417,00							
07.090	base profile for 22 mm glass thickness	417,00							
	<b>Note: Toleranz of glass thickness +/- 0,5 mm</b>								
	<b>Base profile</b> with fixing holes, <b>as safety application</b> on borehole glass preparation incl. clamping parts with screws and gasket strips <b>6000 mm stock length</b>								
07.060	base profile for 8 mm glass thickness	407,00							
07.061	base profile for 10 mm glass thickness	373,00							
	<b>Cover profile</b> 6000 mm stock length	54,00	65,50	65,50	109,00	128,00	109,00	109,00	
	<b>Filler block for wall connecting profile</b> (10 x 12 mm) 6000 mm stock length	59,00	61,50		103,00		103,00	103,00	

Patch fittings and profile systems

## Single components

Art. No.	Description	Base parts (000)	AL mill finish (100)	AL anod Silver (150)	Al p-coat Traffic white (300)	AL anod sim. Stainl-Steel satin (157)	Stainl-Steel satin (700) Stainl-Steel polished (701)	AL anod Special (199)	AL p-coat Special color (399)
		€/m	€/m	€/m	€/m	€/m	€/m	€/m	€/m
	<b>Base profile</b> with fixing holes, incl. clamping parts with screws and gasket strips, <b>fixed length</b>								
07.050	base profile for 8 mm glass thickness	77,00							
07.051	base profile for 10 mm glass thickness	70,00							
07.052	base profile for 12 mm glass thickness	82,00							
07.055	base profile for 12,7 mm glass thickness	85,50							
07.056	base profile for 13,5 mm glass thickness	85,50							
07.057	base profile for 15 mm glass thickness	85,50							
07.058	base profile for 17 mm glass thickness	85,50							
07.059	base profile for 19 mm glass thickness	85,50							
07.091	base profile for 22 mm glass thickness	85,50							
	<b>Note: Toleranz of glass thickness +/- 0,5 mm</b>								
	<b>Base profile</b> with fixing holes, <b>as safety application</b> on borehole glass preparation incl. clamping parts with screws and gasket strips <b>fixed length</b>								
07.066	base profile for 8 mm glass thickness	86,50							
07.067	base profile for 10 mm glass thickness	78,50							
	<b>Cover profile</b> fixed length	11,00	14,00	14,00	22,00	27,50	22,00	22,00	
07.053									
	<b>Filler block for wall connecting profile</b> (10 x 12 mm) fixed length	12,50	13,00		21,00		21,50	21,50	
07.054									

## Single components

Art. No.	Description	Base parts (000)	AL mill finish (100)	AL anod Silver (150)	Al p-coat Traffic white (300)	AL anod sim. Stain-Steel satin (157)	Stain-Steel satin (700) Stain-Steel polished (701)	AL anod Special (199)	AL p-coat Special color (399)	
		€/Piece	€/Piece	€/Piece	€/Piece	€/Piece	€/Piece	€/Piece	€/Piece	
<b>Additional clamping part with screw and gasket</b>										
	<b>07.043</b> for 8 mm glass thickness	11,00								
	<b>07.004</b> for 10 mm glass thickness	10,00								
	<b>07.005</b> for 12 mm glass thickness	12,00								
	<b>07.085</b> for 12,7 mm glass thickness	14,50								
	<b>07.086</b> for 13,5 mm glass thickness	14,50								
	<b>07.087</b> for 15 mm glass thickness	14,50								
	<b>07.088</b> for 17 mm glass thickness	14,50								
	<b>07.089</b> for 19 mm glass thickness	14,50								
	<b>07.094</b> for 22 mm glass thickness	14,50								
<b>Additional clamping part as safety application on borehole glass preparation incl. clamping parts with screws and gasket strips</b>										
	<b>07.063</b> Clamping part for 8 mm glass thickness	14,50								
	<b>07.064</b> Clamping part for 10 mm glass thickness	12,50								
	<b>07.007</b> End cap for 8 – 10 mm glass thickness	8,00	9,40	9,40	15,00	20,00	15,00	15,00		
	<b>07.044</b> End cap for 12 – 13,5 mm glass thickness	10,50	12,50	12,50	17,50	23,00	17,50	17,50		
	<b>07.065</b> End cap for 15 – 19 mm glass thickness	10,50	12,50			23,00	17,50	17,50		
	<b>07.092</b> U-profile 20 x 20 x 2 mm Stock length 6000 mm	€/Piece 36,00	€/Piece 51,50	(101) €/Piece 51,50	€/Piece 88,00		€/Piece 91,50	€/Piece 91,50		
	<b>07.093</b> Fixed length	€/m 7,40	€/m 10,50	€/m 10,50	€/m 17,50		€/m 18,00	€/m 18,00		
	<b>07.097</b> U-profile 30 x 20 x 30 x 2 mm Stock length 6000 mm	€/Piece 70,50	€/Piece 70,50	(101) €/Piece 125,00			€/Piece 128,00	€/Piece 128,00		
	<b>07.096</b> Fixed length	€/m 15,00	€/m 15,00	€/m 26,50			€/m 27,00	€/m 27,00		

Patch fittings and profile systems

## Notes

# Frame systems MR 22 + MR 28



Technical data	
Glass	TSG
Glass thickness	8, 10 mm
Bearing load	No load transmission
Applications	To fix toughened glass elements
Material	Aluminium
Finishes	Anodised-colors ( Alu. silver EV1, Alu. similar satin stainless steel)
Specials	Georgian bar profiles for MR 28, Segmented assemblies with MR 28,



## Fittings for toughened glass assemblies

**184** Patch fitting MUNDUS Comfort

**190** Patch fitting MUNDUS Premium

**198** Patch fitting UNIVERSAL

**207** Patch fitting UNIVERSAL Motion NG33

**208** Patch fitting UNIVERSAL light

**210** Single action door fitting BEYOND

**216** EA-Patch fittings for single action doors

**222** Door rails TP/TA EASY Safe

**234** Door rails TP/TA 76.5

**242** Single action door fitting MANET

**250** Wall connecting profiles

**256** Frame systems MR 22 & MR 28

**260** Centre and corner locks SG, strike boxes

### General accessories for toughened glass assemblies





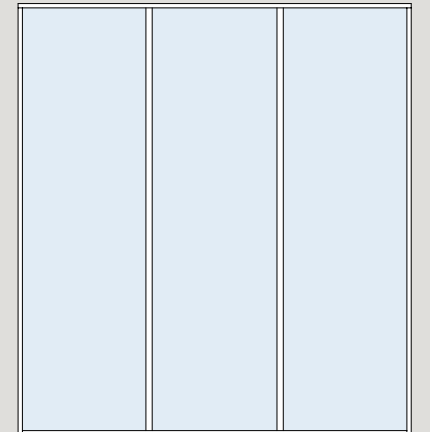
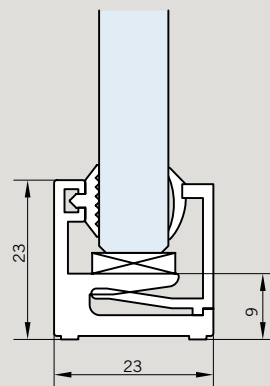

**270** Clamping fitting, U-profile

**271** Pivot bearing, floor bearing, strike plates, floor sockets, profile cylinders

### Example view for frame system MR 22 / MR 28



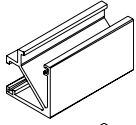
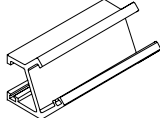

## Single components

Art. No.	Description	AL mill finish (100)	AL anod EV1 (101)	AL anod sim. Stainl-Steel satin (113)
		€/m	€/m	€/m
	<b>07.240 MR 22 Wall connecting profile</b> glass wedge profile and contact profile have to be ordered separately stock length (6000 mm)	€/Piece <b>121,00</b>	€/Piece <b>154,00</b>	€/Piece <b>245,00</b>
	<b>07.250 MR 22 Wall connecting profile</b> incl. glass wedge and contact profile for 8 mm and 10 mm glass Fix length	<b>36,50</b>	<b>42,00</b>	<b>60,50</b>
	<b>07.241 MR 28 Wall connecting profile</b> glass wedge profile and contact profile have to be ordered separately stock length (6000 mm)	€/Piece <b>136,00</b>	€/Piece <b>202,00</b>	€/Piece <b>270,00</b>
	<b>07.251 MR 28 Wall connecting profile</b> incl. glass wedge and contact profile for 8 mm and 10 mm glass Fixed length	<b>39,50</b>	<b>51,50</b>	<b>65,00</b>
	<b>07.242 MR 28 Georgian bar profile 180°</b> glass wedge profile and contact profile have to be ordered separately stock length (6000 mm)	€/Piece <b>77,00</b>	€/Piece <b>99,50</b>	€/Piece <b>157,00</b>
	<b>07.252 MR 28 Georgian bar profile 180°</b> incl. glass wedge and contact profile for 8 mm and 10 mm glass Fixed length	<b>38,00</b>	<b>41,50</b>	<b>54,00</b>
	<b>07.258 MR 28 Georgian bar profile 90°</b> Stock length (6000 mm)	€/Piece <b>286,00</b>	€/Piece <b>395,00</b>	
	<b>07.259 MR 28 Georgian bar profile 135°</b> Stock length (6000 mm)	€/Piece <b>245,00</b>	€/Piece <b>315,00</b>	

**Attention: Profiles are only delivered with straight cuts. Allowances in lengths of profiles to ensure producibility of bevel cuts have to be planned by the customer. The Georgian bar profile must be prepared in addition on both sides. Please consider installation instruction.**

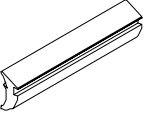
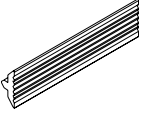
## Single components

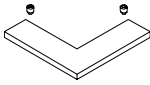
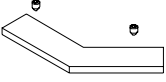
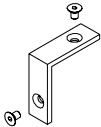
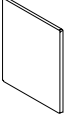
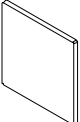
Art. No.	Description	€/Piece	€/Piece	€/Piece
			Base parts (000)	AL anod EV1 (101)
				AL anod sim. Stainl-Steel satin (113)
		€/m		
	<b>07.253</b> <b>Glass wedge profile 2 mm</b> fixed length, for 10 mm glass	<b>3,50</b>		
	<b>07.263</b> on 50 m roll, for 10 mm glass	<b>3,40</b>		
	<b>07.254</b> <b>Glass wedge profile 4 mm</b> fixed length, for 8 mm glass	<b>3,50</b>		
	<b>07.264</b> on 50 m roll, for 8 mm glass	<b>3,40</b>		
	<b>07.255</b> <b>Contact profile 2 mm</b> fixed length, for 8/10 mm glass	<b>2,70</b>		
	<b>07.265</b> on 50 m roll, for 8/10 mm glass	<b>2,60</b>		
	<b>07.256</b> <b>Contact profile 4 mm</b> fixed length, for 6/8 mm glass	<b>2,70</b>		
	<b>07.266</b> on 50 m roll, for 6/8 mm glass	<b>2,60</b>		
	<b>07.248</b> <b>Corner connector for MR 28</b> georgian bar profil 90°		<b>30,50</b>	
	<b>07.249</b> <b>Corner connector for MR 28</b> georgian bar profil 135°		<b>30,50</b>	
	<b>07.247</b> <b>MR 28 Corner connection</b> Set of 4 pieces	<b>40,00</b>		
	<b>07.245</b> <b>End cap MR 22</b>		<b>8,30</b>	<b>10,50</b>
	<b>07.246</b> <b>End cap MR 28</b>		<b>8,30</b>	<b>10,50</b>

Patch fittings and profile systems

# SG Centre and corner locks



<b>Technical data</b>	
Glass	TSG
Glass thickness	8, 10, 12 mm
Lock application	SG
Applications	1-/2 panels, sidelight, overpanel, toughened glass assemblies
Material	Aluminium, stainless steel, brass
Finishes	Anodised- and RAL-Colors, brass color finishes
Specials	Reliable performance characteristics Selected locks tested acc. to DIN EN 18251 Selected locks for panic solutions

## Fittings for toughened glass assemblies

- 184** Patch fitting MUNDUS Comfort
- 190** Patch fitting MUNDUS Premium
- 198** Patch fitting UNIVERSAL
- 207** Patch fitting UNIVERSAL Motion NG33
- 208** Patch fitting UNIVERSAL light
- 210** Single action door fitting BEYOND
- 216** EA-Patch fittings for single action doors
- 222** Door rails TP/TA EASY Safe
- 234** Door rails TP/TA 76.5
- 242** Single action door fitting MANET
- 250** Wall connecting profiles
- 256** Frame systems MR 22 & MR 28
- 260** Centre and corner locks SG, strike boxes

### General accessories for toughened glass assemblies

- 270** Clamping fitting, U-profile
- 271** Pivot bearing, floor bearing, strike plates, floor sockets, profile cylinders

### Example view for SG

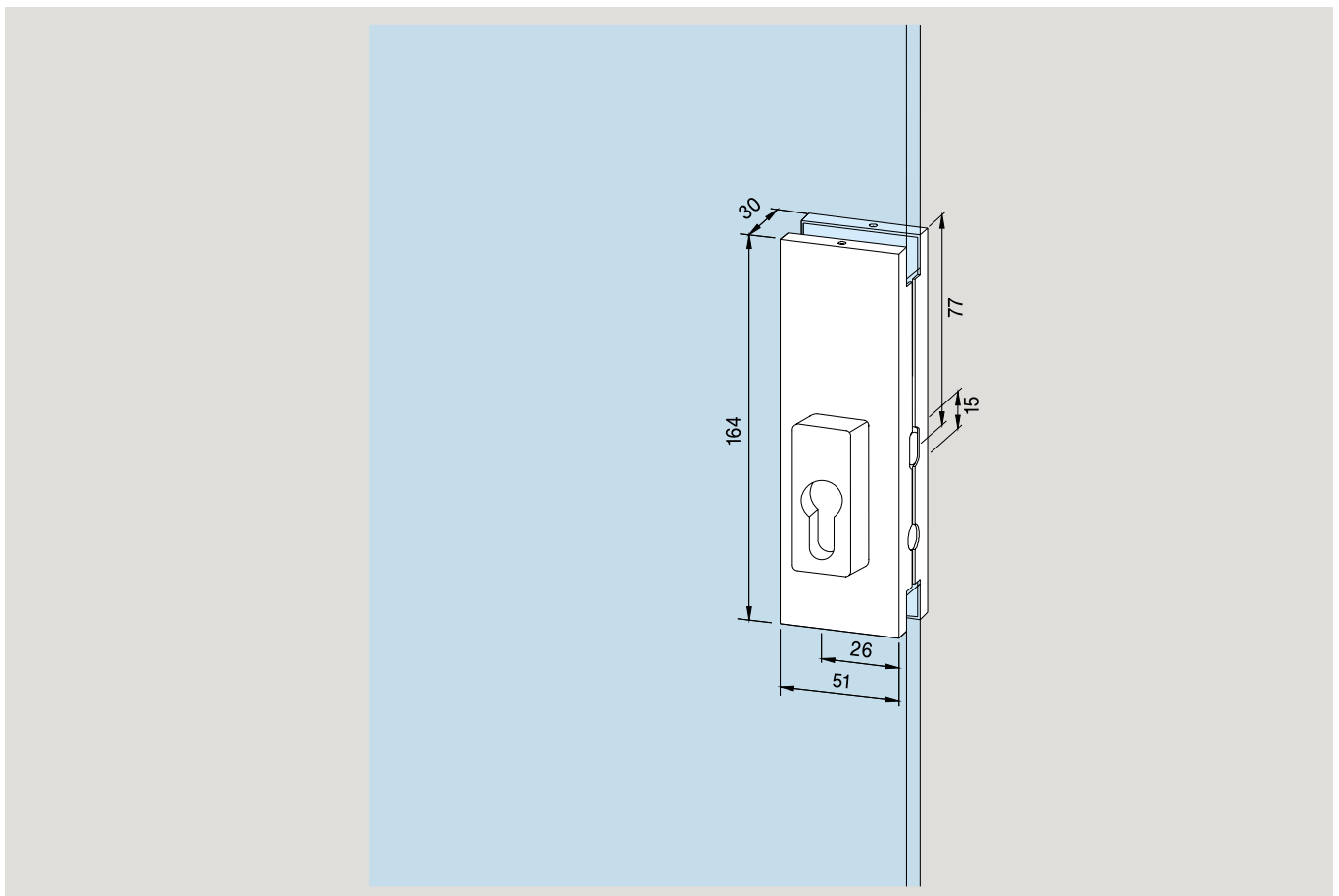

## Locks and strike-boxes for 10 mm glass thickness

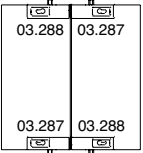

AL anod EV1 (101)    Brass polished (503)    Stainl-Steel satin (700)    Stainl-Steel polished (701)    AL anod Special (199)    AL p-coat Special color (399)

Art. No.	Description	DIN	€/Piece	€/Piece	€/Piece	€/Piece	€/Piece	€/Piece
<b>Single components</b>								
	<b>03.206</b> US 10 corner lock		109,00	155,00	155,00	174,00	153,00	153,00
	<b>03.288</b> US 10 corner lock prepared for half profile cylinder -LH top, -RH bottom		109,00		155,00		153,00	153,00
	<b>03.287</b> do., -LH top, -RH bottom		109,00		155,00		153,00	153,00
	<b>03.230</b> GK 30 overpanel strike-box		113,00		163,00		159,00	159,00
	<b>03.245</b> GK 20 double overpanel strike-box, consisting of 2 x GK 30 with threaded rod		182,00		277,00	307,00	258,00	258,00
	<b>03.250</b> GK 40 corner overpanel strike-box		136,00		193,00	217,00	193,00	193,00
	<b>03.215</b> US 20 centre lock		114,00	164,00	164,00	182,00	162,00	162,00
	<b>03.290</b> US 20 centre lock prepared for half profile cylinder	LH	114,00		164,00		162,00	162,00
	<b>03.289</b> dto.	RH	114,00		164,00		162,00	162,00
	<b>03.224</b> GK 50 strike box		113,00	163,00	163,00		159,00	159,00



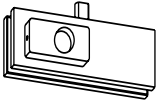
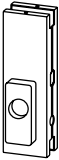

Patch fittings and profile systems

## Locks and strike-boxes for 10 mm glass thickness

AL anod EV1 (101)    Stain-Steel satin (700)    AL anod Special (199)    AL p-coat Special color (399)

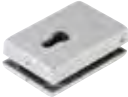
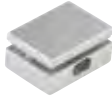
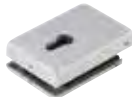







Art. No.	Description	€/Piece	€/Piece	€/Piece	€/Piece
	<b>03.340 US 10, corner lock</b> prepared for round cylinder	126,00	168,00	171,00	171,00
	<b>03.345 US 20, centre lock</b> prepared for round round cylinder	126,00	168,00	171,00	171,00
	<b>03.247 GK 20 double overpanel strike-box</b> consisting of 2 x GK 30 with threaded rod, with stop	300,00	378,00	410,00	410,00

## Locks and strike-boxes for 10 mm glass thickness

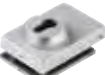
Art. No.	Description	AL	AL	AL	AL
		anod EV1 (101) AL anod Silver (150) €/Piece	anod sim. Stainl- Steel satin (157) €/Piece	anod Special (199) €/Piece	p-coat Special color (399) €/Piece
<b>Single components</b>					
	<b>05.100</b> <b>Corner lock complete for profile cylinder,</b> for 8, 10 and 12 mm glass thickness	100,00	140,00	140,00	140,00
	<b>05.116</b> <b>do., prepared for half profile cylinder,</b> outside blank, inside cylinder hole	113,00	157,00	157,00	157,00
	<b>05.108</b> <b>Strike-box</b> for 05.100 and 05.116. for single doors	56,50		91,00	91,00
	<b>05.103</b> <b>Corner lock complete for profile cylinder,</b> with shortened counterplate, for 8, 10 and 12 mm glass thickness	118,00	166,00	166,00	166,00
	<b>05.117</b> <b>do., prepared for half profile cylinder,</b> outside blank, inside cylinder hole	129,00		183,00	183,00
	<b>05.109</b> <b>Strike-box for 05.103 and 05.117,</b> with stop, for single doors	77,50		123,00	123,00
	<b>05.106</b> <b>Slide over corner lock prep. for profile cylinder</b>	127,00	183,00	183,00	183,00
	<b>05.112</b> <b>Slide over strike-box</b> for 05.106 and 05.107, for single doors	68,00		103,00	103,00







## Locks and strike-boxes for 10 mm glass thickness

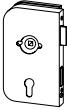

Art. No.	Description	Base parts (000)	AL anod EV1 (101)	AL anod sim. Stainl-Steel satin (157)	AL anod Special (199)	AL p-coat Special color (399)
		€/Piece	€/Piece	€/Piece	€/Piece	€/Piece
	<b>05.105</b> <b>Corner lock complete prepared for round cylinder,</b> for 8, 10 and 12 mm glass thickness	117,00	159,00	163,00	163,00	
	<b>05.107</b> <b>Slide over corner lock prepared for round cylinder</b>	140,00		203,00	203,00	
	<b>05.118</b> <b>Corner lock prepared for profile cylinder,</b> with rose inside	123,00		174,00	174,00	
	<b>05.119</b> <b>Corner lock prepared for profile cylinder,</b> with shortened counter plate and rose inside	139,00		196,00	196,00	
<b>For 12 mm glass thickness</b>						
	<b>05.130</b> <b>Slide over corner lock</b> prepared for profile cylinder	130,00		188,00	188,00	
	<b>05.132</b> <b>Slide over strike-box</b> for 05.130/05.131, for single doors	68,50		96,50	96,50	
	<b>05.190</b> <b>Lock keeper plate,</b> stainless steel, adjustable	16,50				
	<b>05.192</b> <b>Floor socket</b>	8,50				
	<b>05.193</b> <b>Floor socket, dirt protection</b>	17,50				
	<b>05.194</b> <b>Eccentric socket,</b> adjustable	28,00				

Patch fittings and profile systems



## Locks and strike-boxes for 10 mm glass thickness

	Art. No.	Description	DIN	AL	AL	AL	AL
				anod Silver (150)	anod sim. Stainl- Steel satin (157)	anod Special (199)	p-coat Special color (399)
				€/Piece	€/Piece	€/Piece	€/Piece
<b>Single components</b>							
	<b>11.220</b>	<b>Strike-box</b> for 11.217	LH	121,00	153,00	219,00	219,00
	<b>11.221</b>	<b>Strike-box</b> for 11.216	RH	121,00	153,00	219,00	219,00
	<b>11.200</b>	<b>OFFICE Junior lock</b> , prepared for levers with roses	LH	121,00	153,00	219,00	209,00
	<b>11.201</b>	do.	RH	121,00	153,00	219,00	209,00
	<b>11.224</b>	<b>Centre lock with latch and bolt</b> for single action doors, prepared for handle with rose inside	LH	121,00	153,00	219,00	219,00
	<b>11.225</b>	do.	RH	121,00	153,00	219,00	219,00
	<b>11.206</b>	<b>Strike-box</b> for 11.225 and 11.201	LH	102,00	149,00	173,00	163,00
	<b>11.207</b>	<b>Strike-box</b> for 11.224 and 11.200	RH	102,00	149,00	173,00	163,00





## Locks and strike-boxes for 8, 10 and 12 mm glass thickness

Art. No.	Description	DIN	AL	AL	AL	AL
			anod EV1 (101)	anod sim. Stainl-Steel satin (157)	anod Special (199)	p-coat Special color (399)
			€/Piece	€/Piece	€/Piece	€/Piece
	<b>05.200</b> <b>Lock with hook bolt</b> prep. for profile cylinder incl. strike plate suitable for lever handle with roses 10.307 for 8, 10 and 12 mm glass thickness	LH/RH	231,00	301,00	369,00	369,00
	<b>05.202</b> <b>Lock for sliding doors</b> incl. strike plate, for lever handles without roses for 8, 10 and 12 mm glass thickness	LH/RH	231,00	301,00	369,00	369,00
	<b>05.201</b> <b>Strike-box</b> for 05.200/05.202	LH/RH	231,00	301,00	369,00	369,00

## Locks and strike-boxes for 10 mm glass thickness

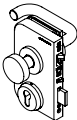
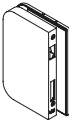

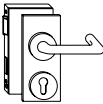
Art. No.	Description	DIN	AL	AL	AL	AL
			anod EV1 (101)	anod sim. (157)	anod Special (199)	p-coat Special color (399)
			€ / Piece	€ / Piece	€ / Piece	€ / Piece
<b>Single components</b>						
	<b>05.224</b> Centre lock with latch and lock bolt prepared for lever with rose inside	LH	191,00	243,00	276,00	276,00
	<b>05.225</b> do.	RH	191,00	243,00	276,00	276,00
	<b>05.228</b> Centre lock with latch and lock bolt, prepared for lever with rose / knob for both sides	LH	214,00	269,00	312,00	312,00
	<b>05.229</b> do.	RH	214,00	269,00	312,00	312,00
	<b>05.226</b> Strike-box with electric strike release for 05.225/05.229	LH	570,00	712,00	782,00	782,00
	<b>05.227</b> Strike-box with electric strike release for 05.224/05.228	RH	570,00	712,00	782,00	782,00
	<b>05.218</b> Angle bracket for centre locks (opening to outside)	LH	17,50	23,00	26,00	26,00
	<b>05.219</b> do.	RH	17,50	23,00	26,00	26,00

## Locks and strike-boxes for 10 mm glass thickness









			AL anod EV1 (101) AL anod Silver (150)	AL anod sim. Stainl- Steel satin (157)	AL anod Special (199)	AL p-coat Special color (399)
Art. No.	Description	DIN	€/Piece	€/Piece	€/Piece	€/Piece
	<b>05.250 SVP lock, Euro profile cylinder with roses</b> Self locking panic lock, tested and certified according to Standard EN 179 Lock with lever inside and knob without function outside, both sides with roses;	LH	only (150) <b>1063,00</b>	<b>1063,00</b>	<b>1123,00</b>	<b>1123,00</b>
	05.251 do.	RH	only (150) <b>1063,00</b>	<b>1063,00</b>	<b>1123,00</b>	<b>1123,00</b>
	<b>05.252 SVP strike box</b> Special strike box for SVP glass lock 05.251	LH	only (150) <b>157,00</b>	<b>182,00</b>	<b>279,00</b>	<b>279,00</b>
	<b>05.253 SVP strike box</b> Special strike box for SVP glass lock 05.250	RH	only (150) <b>157,00</b>	<b>182,00</b>	<b>279,00</b>	<b>279,00</b>
<b>Locks with panic function (opening outside)</b> <b>Not for emergency exit doors according to German standard DIN EN 179 or DIN EN 1125!</b>						
	<b>05.240 Centre lock with latch and lock bolt,</b> with rose handle on inside and fixed knob on outside and profile cylinder roses	LH	<b>449,00</b>	<b>599,00</b>	<b>595,00</b>	<b>595,00</b>
	05.241 do.	RH	<b>449,00</b>	<b>599,00</b>	<b>595,00</b>	<b>595,00</b>
	<b>05.244 Centre lock with latch and lock bolt,</b> with rose handle on inside and fixed knob on outside, profile cylinder roses, suitable for strikebox and electric strike release 05.227	LH	<b>499,00</b>		<b>666,00</b>	<b>666,00</b>
	05.245 do., for 05.226	RH	<b>499,00</b>		<b>666,00</b>	<b>666,00</b>
	<b>05.218 Angle bracket for centre locks</b> (opening to outside)	LH	<b>17,50</b>	<b>23,00</b>	<b>26,00</b>	<b>26,00</b>
	05.219 do.	RH	<b>17,50</b>	<b>23,00</b>	<b>26,00</b>	<b>26,00</b>

Patch fittings and profile systems

## Clamping fittings, U-profiles

Art. No.	Description	Base parts (000)				
		AL anod EV1 (101) AL anod Silver (150)	AL anod sim. (101) Stainl-Steel satin (113)	AL anod Special (199)	AL p-coat Special color (399)	
		€/Piece	€/Piece	€/Piece	€/Piece	€/Piece
<b>U-profile 20 x 20 x 20 x 2 mm</b>						
		(100)				
		€/piece	€/piece	€/piece	€/piece	€/piece
	<b>07.092</b>	Stock length 6000 mm	<b>36,00</b>	<b>51,50</b>	<b>88,00</b>	<b>91,50</b>
	<b>07.093</b>	Fixed length	<b>7,40</b>	<b>10,50</b>	<b>17,50</b>	<b>18,00</b>
			€/m	€/m	€/m	€/m
<b>U-profile 30 x 20 x 30 x 2 mm</b>						
			€/piece	€/piece	€/piece	€/piece
	<b>07.097</b>	Stock length 6000 mm	<b>70,50</b>	<b>125,00</b>	<b>128,00</b>	<b>128,00</b>
	<b>07.096</b>	Fixed length	<b>15,00</b>	<b>26,50</b>	<b>27,00</b>	<b>27,00</b>
			€/m	€/m	€/m	€/m
<b>Clamping fitting</b>						
<b>Clamping fitting, aluminium, with passage hole for M6 thread</b>						
			(only 101)			
	<b>07.037</b>	for 8 mm glass thickness	<b>21,00</b>		<b>38,50</b>	<b>38,50</b>
	<b>07.038</b>	for 10 mm glass thickness	<b>21,00</b>		<b>38,50</b>	<b>38,50</b>
	<b>07.039</b>	for 12 mm glass thickness	<b>21,00</b>		<b>38,50</b>	<b>38,50</b>
			(only 101)			
<b>Double-sided adhesive tape (TESA ACX Plus) for filling the glass gaps between glass elements and for bonding of the glass elements at the same time.</b>						
	<b>50.529</b>	for 10 - 10.76 mm glass thickness, roll of 12 m, 8x3 mm	<b>55,50</b>			
	<b>50.530</b>	for 12 - 12.76 mm glass thickness, roll of 12 m, 10x3 mm	<b>69,50</b>			
	<b>50.531</b>	for 13 - 13.5 mm glass thickness, roll of 12 m, 11x3 mm	<b>77,00</b>			
	<b>50.532</b>	for 15 mm glass thickness, roll of 12 m, 13x3 mm	<b>91,00</b>			
	<b>50.533</b>	for 17 mm glass thickness, roll of 12 m, 15x3 mm	<b>104,00</b>			
	<b>50.534</b>	for 19 mm glass thickness, roll of 12 m, 17x3 mm	<b>119,00</b>			





## Pivots, lock keeper plates, floor sockets, handle fixings, profile cylinder

		Base parts (000)	AL anod EV1 (101)	Stainl-Steel polished (701)	Stainl-Steel satin (700)	AL anod Special (199)	AL p-coat Special color (399)
Art. No.	Description	€/Piece	€/Piece	€/Piece	€/Piece	€/Piece	€/Piece
<b>Pivots, lock keeper plates, floor sockets, handle fixings, profile cylinders</b>							
	<b>01.117 Pivot PT 21</b> with retractable bolt, diametre 15 mm	47,50					
	<b>01.118 Pivot PT 21.1</b> with retractable bolt , diametre 15 mm, incl. cover plate		51,50	55,00	55,00	64,50	64,50
	<b>01.116 Pivot PT 24</b> with fixing plate, material thickness 6 mm with bolt, diametre 15 mm, to let into the ceiling		18,00			27,50	27,50
	<b>01.123 Pivot PT 24</b> with fixingplate, material thickness 3 mm with bolt, diametre 15 mm, to screw on the ceiling		17,50		26,50	26,50	26,50
	<b>01.115 Pivot PT 25</b> with threaded rod , diametre 15 mm	6,30					
	<b>01.129 Top pivot bearing</b> nickel plated	14,00					
	<b>01.130 Top pivot bearing</b> aluminium	14,00					
	<b>01.131 Pivot bearing assembly,</b> with steel ceiling fixing plate, for 15 mm bolt	17,50					
	<b>01.132 Pivot bearing assembly,</b> with aluminium ceiling fixing plate, for 15 mm bolt (for wood, aluminium)		17,00			24,00	24,00

Patch fittings and profile systems

## Pivots, lock keeper plates, floor sockets, handle fixings, profile cylinder







Base parts (000)	AL anod EV1 (101)	Stain-Steel polished (701)	Stain-Steel satin (700)	AL anod Special (199)	AL p-coat Special color (399)
------------------	-------------------	----------------------------	-------------------------	-----------------------	-------------------------------

Art. No.	Description	€/Piece	€/Piece	€/Piece	€/Piece	€/Piece	€/Piece
<b>Floor bearing</b>							
	<b>01.106</b> Floor pivot bearing with round pivot (stainless steel) and fixing plate	57,00	68,50	62,50	73,00	73,00	
	<b>01.107</b> Floor bearing	31,50					
	<b>04.602</b> Floor pivot bearing with flat tapered spindle	79,50					
	<b>04.770</b> do., but 2,5 mm enhanced spindle	92,50					
	<b>04.771</b> do., but 5 mm enhanced spindle	92,50					
	<b>04.772</b> do., but 10 mm enhanced spindle	92,50					
	<b>04.773</b> do., but 15 mm enhanced spindle	92,50					
	<b>04.774</b> do., but 20 mm enhanced spindle	92,50					
	<b>04.603</b> Floor bearing with flat tapered spindle version stainless steel	192,00					
	<b>01.136</b> Screw-on floor bearing moistureproof, compl. with insert for door rails, max. 100 kg	71,00					
	<b>01.137</b> Floor pivot bearing for damp environments, with insert for UNIVERSAL for mounting onto floor surface, max. door weight 80 kg	62,50					



## Floor sockets, lock keeper plates, floor sockets, profile cylinder

Base parts  
(000)

	Art. No.	Description	€/Piece
	<b>05.190</b>	Lock keeper plate, stainless steel, adjustable	<b>16,50</b>
	<b>05.192</b>	Floor socket	<b>8,50</b>
	<b>05.193</b>	Floor socket, dirt protection	<b>17,50</b>
	<b>05.194</b>	Eccentric socket, adjustable	<b>28,00</b>
	<b>01.136</b>	Screw-on floor bearing, moistureproof, without floor insert, complete with insert for door rails, max. 100 kg	<b>71,00</b>
	<b>05.001</b>	Profile cylinder, length 61 mm long, differently keyed	<b>30,50</b>
	<b>05.002</b>	do., equally keyed	<b>30,50</b>
	<b>05.003</b>	Half profile cylinder length, 31 mm, differently keyed,	<b>28,50</b>
	<b>05.004</b>	do., equally keyed	<b>28,50</b>

Patch fittings and profile systems



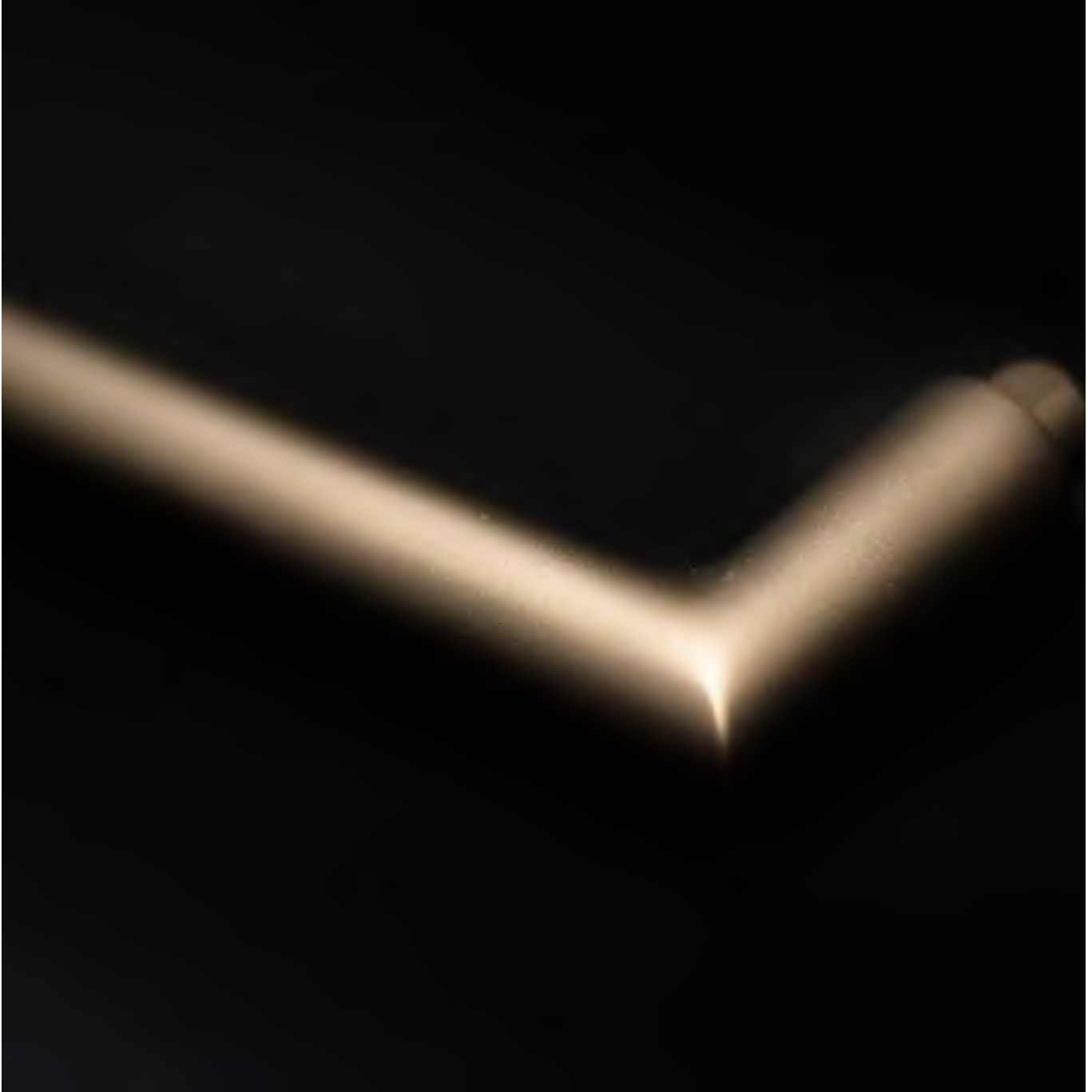

## Notes

# Levers, handle bars and pull grips



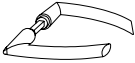
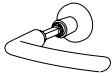
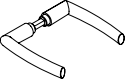
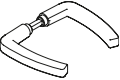







Levers & handles



Levers for locks with follower

		AL anod Silver (150)	AL anod EV1 Deco (114)	AL anod sim. Stainl- Steel satin (157)	AL p-coat Jet black (304)	AL anod Special (199)	AL p-coat Special color (399)	Stainl- Steel satin (700)
Art. No.	Description	€/Pair	€/Pair	€/Pair	€/Pair	€/Pair	€/Pair	€/Pair
	<b>24.301 Arcos set of levers</b> aluminium/brass	73,50	87,50			113,00	113,00	
	<b>24.316 Arcos lever and knob set</b> with Arcos lever and free turnable knob (turnable knob without function)	86,50	93,00					
	<b>24.310 Aluminium set of levers</b> Arcos oval	73,50	87,50			113,00	113,00	
	<b>24.312 Aluminium set of levers</b> Arcos angular	81,00	98,00			120,00	120,00	
	<b>Sets of levers for STUDIO Classic</b>							
<b>10.010</b>	Lever for do.	24,00	33,00	33,00	40,00	40,00		
	<b>Sets of levers for STUDIO Gala 2.0</b>							
<b>19.009</b>	Lever for do.	46,50	64,00	64,00	82,00	82,00		
	<b>52.330 L-shape lever 33</b>				45,50			42,00



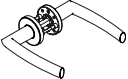
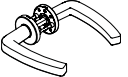

## Levers for locks with follower

Art. No.	Description	AL anod Silver (150)	AL anod sim. Stain-Steel satin (157)	AL p-coat Jet black (304)	Stain-Steel satin (700)	AL anod Special (199)	AL p-coat Special color (399)
		€/Pair	€/Pair	€/Pair	€/Pair	€/Pair	€/Pair
<b>Sets of levers for locks with follower</b>							
<b>STUDIO Rondo/Classic/Gala 2.0</b>							
<b>OFFICE Junior/Classic</b>							
	<b>10.314</b> Rondo lever	24,00	33,00	33,00		40,00	40,00
	<b>10.304</b> Rondo lever, knob set reversible	59,50	86,50			108,00	108,00
	<b>11.299</b> Junior lever, satin stainless steel				150,00		
	<b>10.301</b> Tubular lever	56,50	64,00	64,00		82,00	82,00
	<b>10.322</b> do. but with stainless steel square drive	68,50	77,00			102,00	102,00
	<b>10.329</b> L-shape lever	50,00	50,00	57,00			60,00
	<b>10.305</b> Aluminium knob set	38,00	63,00			72,50	72,50
	<b>10.316</b> Lever and knob set for Rondo/Junior, with tubular lever and free turnable knob for lock without roses (without function)	79,00	93,00			114,00	114,00
	<b>10.317</b> Lever and knob set for Rondo/Junior, with tubular lever turn knob for lock without roses (with function)	70,00	82,00			102,00	102,00

## Levers with roses

Art. No.	Description	AL anod Silver (150) €/Pair	AL anod EV1 Deco (114) €/Pair	AL anod sim. Stain- Steel satin (157) €/Pair	AL anod Special (199) €/Pair	AL p-coat Special color (399) €/Pair
	<b>24.307</b> Arcos set of levers	105,00	121,00	139,00	139,00	
	<b>24.318</b> Arcos lever and knob set with Arcos lever and fixed knob (knob without function)	120,00	131,00			
	<b>24.322</b> Set of levers for wooden doors incl. warded key rose	108,00	125,00			
	<b>24.323</b> Set of levers for wooden doors incl. profile cylinder rose	108,00	125,00			
	<b>24.324</b> Set of levers for wooden doors incl. vacant/occupied indicator	128,00	147,00			
	<b>24.311</b> Aluminium set of levers Arcos oval	105,00	121,00	139,00	139,00	
	<b>24.313</b> Aluminium set of levers Arcos angular	111,00	129,00	139,00	139,00	

## Levers with roses

Art. No.	Description	AL anod Silver (150)	AL anod sim. Stainl- Steel satin (157)	AL p-coat Jet black (304)	AL anod Special (199)	AL p-coat Special color (399)
		€/Pair	€/Pair	€/Pair	€/Pair	€/Pair
<b>Lever sets with roses</b> for STUDIO and OFFICE locks						
	<b>10.307</b> Tubular levers with roses, aluminium	65,50	77,00	73,50	100,00	100,00
	<b>10.325</b> do. but with stainless steel square drive	78,00	95,00		113,00	113,00
<b>not illustrated</b>	<b>10.331</b> L-shaped lever with roses, aluminium	91,50	108,00	104,00	116,00	116,00
	<b>11.226</b> Tubular lever handle with roses for locks 11.224/11.225, only for inside	36,00	40,50	49,00	49,00	49,00
	<b>10.318</b> Lever and knob set for STUDIO / OFFICE locks, with tubular lever and fixed knob, with roses (without function)	113,00	130,00		155,00	155,00
	<b>10.319</b> Lever and knob set for STUDIO / OFFICE locks, with tubular lever and turn knob, with roses (with function)	103,00	121,00		142,00	142,00

## Handle bars

Stain-  
Steel  
satin  
(700)

Art. No. Description



		<b>Pull handle, with countersunk single-point fixing,</b> for 8, 10 and 12 mm glass thickness	
<b>29.268</b>	350 mm, with 2 fixings		<b>129,00</b>
<b>29.269</b>	do. (AISI 316L)		<b>259,00</b>
<b>29.271</b>	720 mm, with 2 fixings		<b>155,00</b>
<b>29.272</b>	do. (AISI 316L)		<b>270,00</b>
<b>29.274</b>	1,240 mm, with 3 fixings		<b>267,00</b>
<b>29.275</b>	do. (AISI 316L)		<b>329,00</b>
<b>29.277</b>	1,760 mm, with 4 fixings		<b>289,00</b>
<b>29.278</b>	do. (AISI 316L)		<b>424,00</b>



		<b>Pull handle, with clamping disc single-point fixing,</b> for 8, 10 and 12 mm glass thickness	
<b>21.240</b>	350 mm with 2 fixings		<b>136,00</b>
<b>21.241</b>	720 mm with 2 fixings		<b>162,00</b>
<b>21.281</b>	do. (AISI 316L)		<b>305,00</b>
<b>21.242</b>	1,240 mm with 3 fixings		<b>286,00</b>
<b>21.243</b>	1,760 mm with 4 fixings		<b>329,00</b>
<b>21.283</b>	do. (AISI 316L)		<b>534,00</b>



		<b>Back to back pull handles incl. connecting bolt</b> for 8, 10 and 12 mm glass thickness	€/Pair
<b>21.267</b>	350 mm with 2 fixings		<b>183,00</b>
<b>21.247</b>	do. (AISI 316L)		<b>394,00</b>
<b>21.270</b>	720 mm with 2 fixings		<b>229,00</b>
<b>21.250</b>	do. (AISI 316L)		<b>470,00</b>
<b>21.273</b>	1,240 mm with 3 fixings		<b>411,00</b>
<b>21.253</b>	do. (AISI 316L)		<b>545,00</b>
<b>21.276</b>	1,760 mm with 4 fixings		<b>461,00</b>
<b>21.256</b>	do. (AISI 316L)		<b>651,00</b>

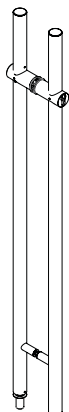











		<b>Lockable back to back pull handle</b> for 17,5 mm glass 1200 mm length, with 2 fixings and floor socket, prepared for standard profile cylinder	
<b>21.580</b>	lockable from both sides, cylinder length 30/160		€/Pair <b>596,00</b>
<b>21.581</b>	lockable from one side, cylinder length 30/10		€/Pair <b>596,00</b>



## Notes

## Pull grips and door knobs

Art. No.	Description	Base parts	AL	AL	Stain-	AL	AL
		(000)	anod EV1 (101)	anod sim. Stain-Steel satin (113)	Steel satin (700)	anod Special (199)	p-coat Special color (399)
		€/Piece	€/Piece	€/Piece	€/Piece	€/Piece	€/Piece
	<b>07.200 Recessed pull grip</b> for 8, 10 and 12 mm glass thickness		65,50	100,00		111,00	111,00
	<b>21.290 Recessed pull grip</b> for 8/10/12 mm glass diameter 50 mm					57,00	
	<b>21.291 Recessed pull grip</b> for 8/10/12 mm glass, diameter 60 mm					86,50	
	<b>Recessed pull grip with grip hole</b> diameter 60 mm						
	<b>21.292</b> for 8 mm glass					105,00	
	<b>21.293</b> for 10 mm glass					106,00	
	<b>21.294</b> for 12 mm glass					107,00	
	<b>21.422 Single door knob</b> for 8/10/12 mm glass with countersunk single-point fixing					91,00	
	<b>21.426 Single door knob</b> for 8/10/12 mm glass with clamping disc single-point fixing					86,50	
	<b>21.423 Back to back door knob</b> for 8/10/12 mm glass					83,00	
	<b>07.201 Door knob</b>		111,00	162,00		190,00	190,00
	<b>13.005 For sauna doors</b> Wooden handle for Sauna		54,00				
	<b>13.006</b> Wooden snapper block for Sauna		23,50				

## Pull grips and door knobs

Stainl-  
Steel  
satin  
(700)

Art. No.	Description	€/Piece
	<p><b>Conversion set for back to back pull handles and door knobs, one set for each fixing needed</b></p> <p><b>21.285</b> Set 1 - glass thickness 13.5 - 21.5 mm</p> <p><b>21.286</b> Set 2 - timber thickness 20 - 40 mm</p>	<p><b>23,50</b></p> <p><b>30,50</b></p>
	<p><b>Conversion set "distance extension" for pull handles and knobs, for glass and timber doors in 15 - 40 mm thickness one set for each fixing needed (Not applicable for Arcos pull handles 26.500/26.510)</b></p> <p><b>21.287</b> Set 3 - single-sided counter sunk</p> <p><b>21.288</b> Set 4 - single sided clamping disc</p>	<p><b>31,00</b></p> <p><b>37,00</b></p>
	<p><b>Conversion set for recessed pull grips,</b></p> <p><b>21.295</b> Set 5 - glass thickness 13,5 - 21,5 mm</p> <p><b>21.296</b> Set 6 - timber thickness 20 - 40 mm</p>	<p><b>24,00</b></p> <p><b>24,00</b></p>
	<p><b>Conversion set for changing back-to-back pullhandles into single sided pull handles, for glass and timber doors in 8 - 40 mm thickness, one set for each fixing needed (Not applicable for Arcos pull handles 26.500/26.510.)</b></p> <p><b>21.297</b> Set 7 - single sided counter sunk</p> <p><b>21.298</b> Set 8 - single sided clamping disc</p>	<p><b>50,50</b></p> <p><b>50,50</b></p>

## Color samples

			€/Piece
	<b>8.10.902.000.99</b>	<p><b>Color samples</b></p> <p><b>Aluminium, mill finish and anodized</b></p> <p>AL anodized, EV1, sanded, matte (for profiles: stained, matte) (101)            AL anodized, EV1 Deco, satin, matte (compatible with finish 150) (114)            AL anodized, Silver, satin, matte (compatible with finish 114) (150)            AL anodized, similar stainless steel, polished, matte (107)            AL anodized, similar stainless steel, satin (157)            AL powder coated, Jet black, smooth, matte (sim. RAL 9005) (304)            AL powder coated, similar stainless steel, smooth, semi gloss (330)            AL powder coated, similar anodized Silver, smooth, matte (331)            AL powder coated, Traffic white, smooth, semi gloss (sim. RAL 9016) (350)</p>	netto <b>24,50</b>
		<b>8.10.904.000.99</b>	<p><b>Stainless steel, various finish treatments</b></p> <p>Stainless steel, satin (compatible with 700) (750)            Stainless steel, polished (compatible with 701) (751)</p>
	<b>8.10.906.000.99</b>	<p><b>Trend colors</b></p> <p>AL special color powder coated (399):            AL Rust satin powder coated (Fine texture Perl)            AL Silver satin powder coated (Fine texture Perl)            AL Light grey satin powder coated (RAL 7035, Fine texture)            AL Jet black satin powder coated (RAL 9005, Fine texture)</p>	netto <b>8,50</b>
	<b>8.38.000.100.99</b>	<p><b>MUNDUS</b></p> <p>AL anodized, Silver, satin, matte (compatible with finish 114) (150)            Stainless steel, satin (compatible with 700) (750)            Stainless steel, polished (compatible with 701) (751)</p> <p>AL special color anodized (199):            Dark Niro            Antique brass            Black bronze</p>	netto <b>24,50</b>

## Notes

Standard finishes and colors		MUTO	RS 120	MANET	STUDIO Rondo	STUDIO Classic	STUDIO Gala 2.0	STUDIO Arcos	STUDIO 1121	STUDIO Medio
<b>Aluminium, mill finish and anodized</b>										
101	AL anodized, EV1, sanded, matte (for profiles: stained, matte)		●							
107	AL anodized, similar stainless steel, polished, matte									
113	AL anodized, similar stainless steel, satin (for profile material) (similar Anodizing II C 31)		●							
114	AL anodized, EV1 Deco, satin, matte (compatible with finish 150)							●		
150	AL anodized, Silver, satin, matte (compatible with finish 114)	●			●	●	●			●
157	AL anodized, similar stainless steel, satin	●			●	●	●	●		●
<b>Aluminium, powder coated</b>										
300	AL powder coated, Traffic white, smooth, glossy (sim. RAL 9016)		●						●	
304	AL powder coated, Jet black, smooth, matte (sim. RAL 9005)	●			●	●	●	●	●	●
350	AL powder coated, Traffic white, smooth, semi gloss (sim. RAL 9016)	●							●	
<b>Brass, various finish treatments</b>										
503	Brass, polished									
<b>Stainless steel, various finish treatments</b>										
700	Stainless steel, satin (compatible with 750)			●						
701	Stainless steel, satin (for MUNDUS) (compatible with 700)									
750	Stainless steel, polished (compatible with 751)									
751	Stainless steel, polished (for MUNDUS) (compatible with 701)									

Further finishes for single products are specified on the appr. price list pages.

OFFICE Junior	OFFICE Classic	OFFICE Mundus	OFFICE Arcos	BEYOND	EA Eckbe- schläge	TENSOR	MARCATO Motion	EA patch fittings	MUNDUS Premium	UNIVERSAL
					•					•
				•	•					
						•	•			
			•	•		•	•			
•	•	•						•	•	
•	•	•	•							
•	•	•				•	•			
										•
•										•
										•
		•						•	•	
		•						•	•	

## Manual Sliding Doors

Page 17	MUTO Comfort M 60 Example solution for: installation at wall	1 x MUTO Comfort M 60 standard set, Art. No. 36.670 Handle bar, Art. No. 36762630432 Glass type: Design example
Page 23	MUTO Comfort L 80 Example solution for: Ceiling installation in wall opening	1 x MUTO Comfort L 80, Art. No. 36.306 1 x Pair of handle bars Art.-Nr. 21.273 + MUTO floor profile Glass type: Design example
Page 33	MUTO Comfort L 80 Pocket Ceiling slot / wall pocket	1 x MUTO Comfort L 80 Pocket sliding door set for wall pocket installation (incl. DORMOTION unit closing direction and push-to-open unit opening direction) Art. No. 36.162 1 x Pull grip Art. No. 07.200 Glass type: Design example
Page 41	MUTO Premium XL 80 Example solution for: Installation at ceiling, 2-leaf	1 x MUTO Comfort XL 80 standard set, Art. No. 36.529 2 x Handle bar, Art. No. 50.520 Glass type: Design example
Page 53	MUTO Premium-Self-Closing 120 Example solution for: Installation at ceiling, 2-leaf	1 x MUTO Premium-Self-Closing 120 standard set, Art. No. 36.610 1 x Handle bar, Art. No. 50.520 Glass type: Design example
Page 63	MUTO Premium Telescopic 80 Example solution for: Installation at ceiling, with sidelight	Art. No. 36.704 1 x Handle bar, Art. Nr. 21.276 Glass type: Design example
Page 81	RS 120 Example solution for: Installation at wall, single-leaf	2 x RS 120 Set, Art. No. 07.135 1 x Track, Art. No. 07.131 1 x Covering profile, Art. No. 07.141 1 x Pull grip, Art. No. 21.291 2 x End caps, Art. No. 07.127 Glass type: Design example
Page 91	MANET Example solution for: Installation at wall	2 x MANET Set, Art. No. 29.918 1 x Track tube, Art. No. 21.436 1 x Pull grip Art. No. 21.290 Glass type: Design example



## Manual single action doors

Page 104	STUDIO Rondo	1 x STUDIO Rondo lock, Art. No. 10.200 2 x OFFICE Junior Hinge, Art. No. 11.230 2 x Screw-on frame pivot, Art. No. 11.405 1 x Lever, Art. No. 52.330 Glass type: Design example
Page 112	STUDIO Classic	1 x STUDIO Classic lock, Art. No. 10.002 2 x OFFICE Classic Hinge, Art. No. 11.288 2 x Frame pivot, Art. No. 11.310 1 x Lever, Art. No. 10.010 Glass type: Design example
Page 118	STUDIO Gala 2.0	1 x STUDIO Gala 2.0 lock, Art. No. 19.611 2 x OFFICE Arcos Hinge, Art. No. 25.230 2 x Frame pivot, Art. No. 11.309 1 x Levers on site Glass type: Design example
Page 124	STUDIO Arcos	1 x STUDIO Arcos lock, Art. No. 24.201 2 x OFFICE Arcos Hinge, Art. No. 25.230 2 x Frame pivot, Art. No. 11.310 1 x Lever, Art. No. 24.301 Glass type: Design example
Page 130	STUDIO1121	1 x lock 10.149, 1 x Rondo Lever 10.314 Glass type: Design example
Page 134	STUDIO Medio	1 x STUDIO Medio lock, Art. No. 10.510 2 x OFFICE Arcos Hinge, Art. No. 25.230 2 x Frame pivot, Art. No. 11.310 1 x Lever, Art. No. 24.312 Glass type: Design example
Page 138	OFFICE Junior	1 x OFFICE Junior lock, Art. No. 11.260 2 x OFFICE Junior Hinge, Art. No. 10.329, 2 x Frame pivot, Art. No. 11.309 1 x Lever, Art. No. 10.307, Glass type: Design example
Page 144	OFFICE Classic	1 x OFFICE Classic lock, Art. No. 11.284 2 x OFFICE Classic Hinge, Art. No. 11.288, 2 x Frame pivot, Art. No. 11.309 1 x Lever, Art. No. 11.299, Glass type: Design example
Page 150	OFFICE Mundus	1 x OFFICE Mundus lock, Art. No. 11.838 1 x OFFICE Mundus strike box, Art.-Nr. 11.849
Page 154	OFFICE Arcos	1 x OFFICE Arcos lock, Art. No. 25.260, 2 x OFFICE Arcos Hinge, Art. No. 25.230 2x Screw-on frame pivot, Art. No. 11.405, 1 x Lever, Art. No. 24.301 Glass type: Design example

## Manual single action doors

Page 172

TENSOR

4 x TENSOR Hinge, Art. No. 12.527  
Glass type: Design example

## Fittings for toughened glass assemblies

Page 184	MUNDUS Comfort	<ul style="list-style-type: none"> <li>1 x PT 10, Art. No. 38.100</li> <li>1 x PT 20, Art. No. 38.200</li> <li>1 x PT 40, Art. No. 38.400</li> <li>1 x PT 60, Art. No. 38.600</li> <li>1 x Floor spring, Art. No. 01.106</li> <li>1 x Mundus lock 11.838, Mundus GK 11.849 and lever</li> <li>+ Wall connection profile (side + top)</li> <li>+ U-profile (bottom)</li> <li>Glass type: Design example</li> </ul>
Page 190	MUNDUS Premium, 2-leaf	<ul style="list-style-type: none"> <li>2 x PT 10, Art. No. 42.100</li> <li>2 x PT 20, Art. No. 42.200</li> <li>2 x PT 40, Art. No. 42.400</li> <li>2 x Floor spring, Art. No. 01.106</li> <li>2 x Pair of handle bars, Glass type: Design example</li> </ul>
Page 198	UNIVERSAL	<ul style="list-style-type: none"> <li>2 x PT 10, Art. No. 03.100,</li> <li>2 x PT 20, Art. No. 03.110</li> <li>2 x PT 40, Art. No. 03.140,</li> <li>2 x Floor spring, Art. No. 01.106</li> <li>2 x Pair of handle bars, Art. No. 21.273</li> <li>+ Wall connection profile (side + top) + U-profile (bottom)</li> <li>Glass type: Design example</li> </ul>
Page 212	BEYOND	<ul style="list-style-type: none"> <li>1 x Complete set, Art. No. 30.110,</li> <li>1 x Fanlight connector, Art. No. 30.130</li> <li>1 x Floor spring, Art. No. 01.106,</li> <li>1 x Glass connector, Art. No. 30.120</li> <li>+ Wall connection profile</li> <li>Glass type: Design example</li> </ul>
Page 242	MANET	<ul style="list-style-type: none"> <li>1 x Complete set, Art. No. 29.912, 29.914</li> <li>1 x Sidelight connector, Art. No. 29.320</li> <li>1 x US 20, Art. No. 03.224,</li> <li>1 x GK 50, Art. No. 03.224</li> <li>1 x Pair of handle bars, Art. No. 21.267,</li> <li>Glass type: Design example</li> </ul>
Page 250	Wall connection profile	<ul style="list-style-type: none"> <li>2 x PT 10, Art. No. 03.100,</li> <li>2 x PT 20, Art. No. 03.110</li> <li>2 x PT 40, Art. No. 03.140,</li> <li>2 x Floor spring, Art. No. 01.106</li> <li>2 x Pair of handle bars, Art. No. 21.273</li> <li>+ Wall connection profile (side + top) + U-profile (bottom)</li> <li>Glass type: Design example</li> </ul>

## Notes

## Notes

## Notes



# Moving Details.



**DORMA-Glas GmbH**

Max-Planck-Straße 33-45  
D - 32107 Bad Salzufen

T +49 5222 924-0

[info@dorma-glas.com](mailto:info@dorma-glas.com)  
[www.dorma-glas.com](http://www.dorma-glas.com)

 DORMA-Glas GmbH  
 DORMA-Glas GmbH



WN 054 578 51532, 01/24, EN  
Subject to change without notice